

MATCHSTICK MODELS AND OTHER SCIENCE EXPERIMENTS

By Arvind Gupta email: arvindguptatoys@hotmail.com

CHILDREN'S WORLD

Children learn by doing. They learn a great deal by tinkering & pottering playing with or simply messing things around them. It is in these free acts that children familiarize themselves with the properties of a lot of common things and everyday phenomenon.

Children love to do things. They are by nature eternal explorers. The most commonplace and insignificant phenomenon from the adult point of view intrigues them - be it the rustling of leaves, the chirping and flight of the sparrow, the falling of water from the tap, or the spewing of smoke from an extinguished matchstick. All these capture, excite and enrapture a child's imagination. To a child no object is insignificant. Everything is to be tasted, toppled, turned and tested in order to test it. Every event, happening and thing warrants attention and further exploration. The humblest looking object becomes sources of unending intrigue and joy. An ordinary matchbox becomes a 'magic box'. It transforms into a rattle when shaken. Its drawer floats like a boat in water. The matchbox is a trunk, box, wagon, tow-car, tiffin box and a secret cache all rolled into one. Every child has an assortment of odds, bits and trinkets - shoe polish tins, broken pens, discarded cardboard boxes, used bottles and few bangles and other throwaway junk, which constitute her/his most cherished treasure trove.

Children are very imaginative. The whole world is art for them. It is usual for them to construct castles in the sand and see outlines of animals and birds in pebbles and stones. Fallen twigs and blades of grass, the arrangement of leaves, spilled ink on the door or the changing colour palette of the sky are all fascinating patterns and designs for the child. But slowly this innate curiosity and creativity of the child is squashed by the authoritarian and patriarchal structures of the family, school and society. Thus, as a child grows up, the artist within her/him goes to sleep. Art, which earlier embodied the whole world is now reduced to the frame of a canvas painting, murderously hung from the wall.

This booklet attempts to give a glimpse of some of the experiments and toys designed as part of the Hoshangabad Science Teaching Programme. Intensive use is made of things which are commonly available and with which the children are familiar. Many of the experiments were designed, often with the help of village children and teachers, in response to the dismal poverty existing in most village school.

Today science has become synonymous with fancy glassware and expensive laboratories. The learning of science is being equated with an ability to mug up definitions and formulae. But is this good science?

Science, in essence, is a viewpoint – a worldview, an ability to critically examine phenomenon. It is an ability to see patterns, structures, sequences, trends, and commonalities, regularities and generalities - in short, an ability to perceive and discover an order in the universe. From this point of view every object is a piece of science apparatus and every child is a budding scientist. To explore answers to her/his questions is the basic right of every child. The present day school's attitude towards children can be summed up as follows:

We give them solutions and keep the confidence to ourselves.

We give them memory but keep the thinking to ourselves.

We give them marks and keep the knowledge to ourselves.

The pity is that we have never asked the children real problems, and whenever we did, it has been with the intention of hearing to the same regurgitated solutions that we gave them. This must end.

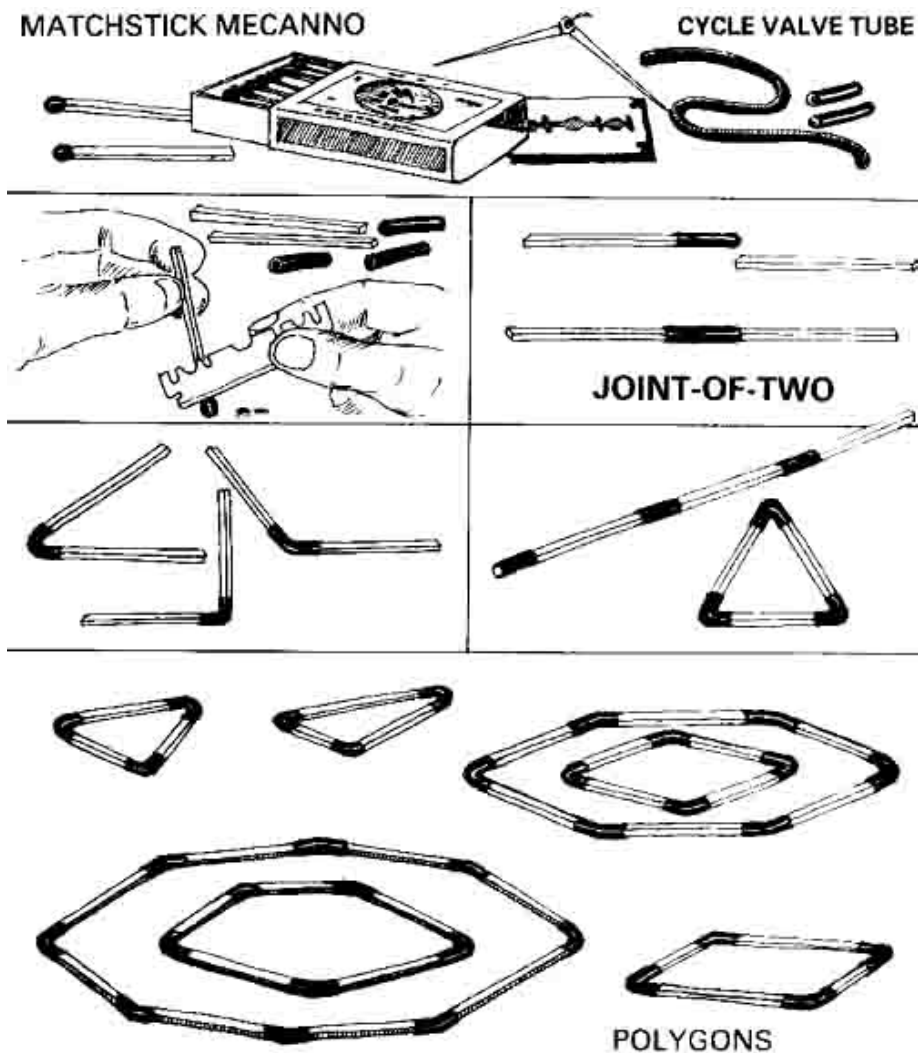

MATCHSTICK MODELS

Any mecano, even of the most expensive sort, when stripped of its trappings essentially reduces to a few building blocks and couplings. These blocks and couplings can be joined together in a variety of ways to create an array of different structures and configurations:

The matchstick mecano uses matchsticks as the basic structural members and bits of cycle valve tube as the joints. Cycle valve tube is sold by weight in cycle shops.

A 100-gms packet costs Rupees 15, and contains about 16 meters (or 50 feet) of valve tube.

JOINT - OF - TWO

Cut about 15-cm long pieces of the valve tube. Scrape the sulfur from matchstick heads with a blade. Push one end of a matchstick through a valve tube piece. You'll find that the matchstick slides snugly in the valve tube. Push a second matchstick through the other end of the valve tube piece.

The ends of both the matchsticks should touch head-to-head inside the valve tube.

This is a joint of two matchsticks, or simply a **joint-of-two**. The flexible **joint-of-two** can be used for illustrating angles – acute; right; obtuse and straight angles.

Three matchstick and three valve tube pieces in a row can be looped together to make a triangle.

As the matchsticks are the same lengths the triangle turns out to be equilateral - with all sides equal.

All the angles in this triangle are equal and measure 60 degrees.

Other shapes like isosceles triangle, squares, rectangles, pentagons, hexagons and octagons can be made by joining together more matchsticks and more valve tube pieces.

A whole range of polygons can be made in this way.

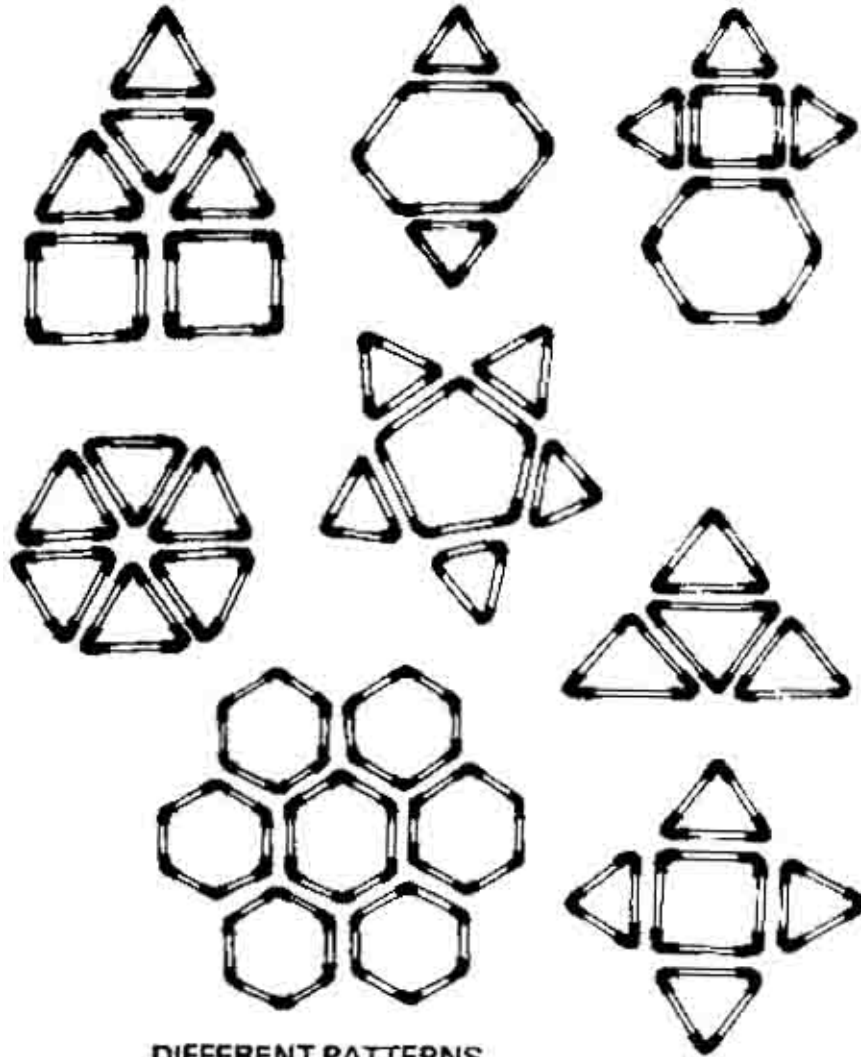

DIFFERENT PATTERNS

DIFFERENT PATTERNS

Make several triangles, squares, rectangles, pentagons and hexagons.

Now arrange these shapes into different patterns.

You can discover several new patterns on your own.

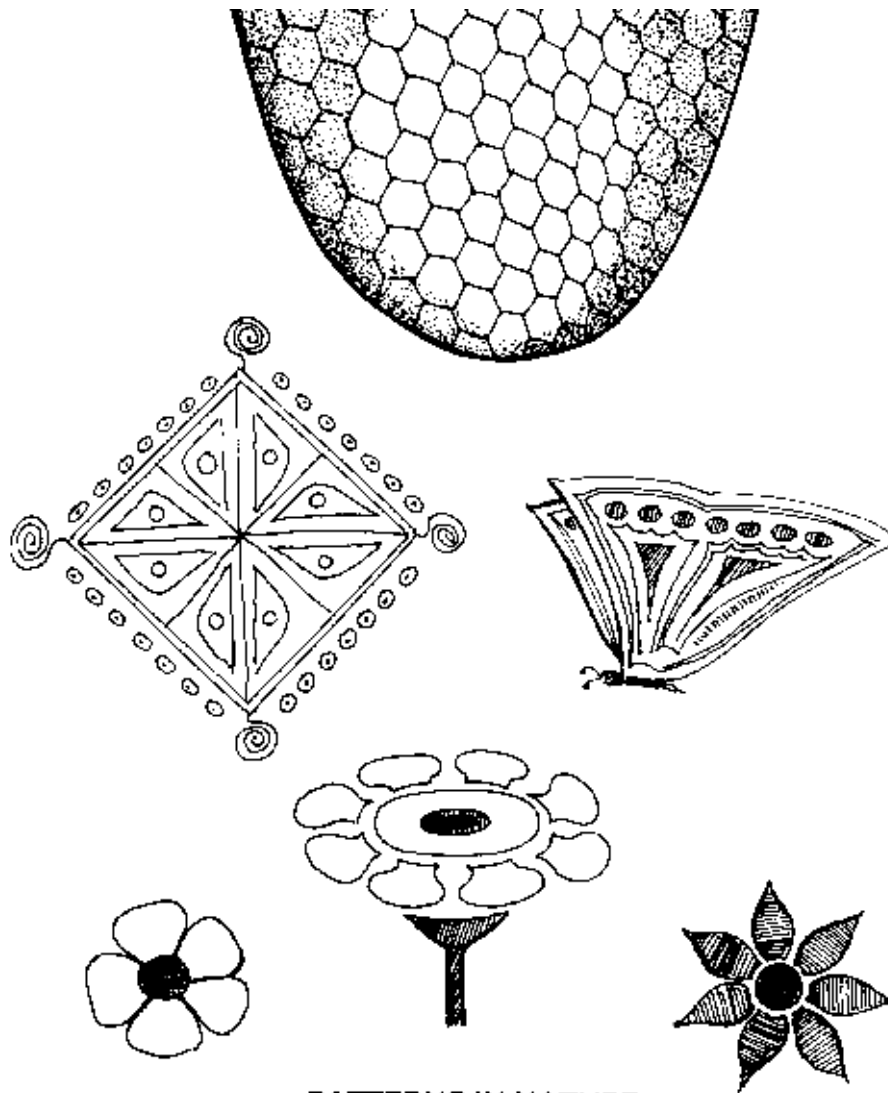

PATTERNS IN NATURE

PATTERNS IN NATURE

Nature provides us with a whole array of patterns.

Often putting together a few basic shapes in a definite order makes these patterns.

We get a glimpse of nature's designs in the honeycomb, arrangement of flower petals, the symmetric patterns on a butterfly's wings and a myriad other places.

Some examples of human made patterns are the fixing of floor tiles, and the traditional 'rangoli.'

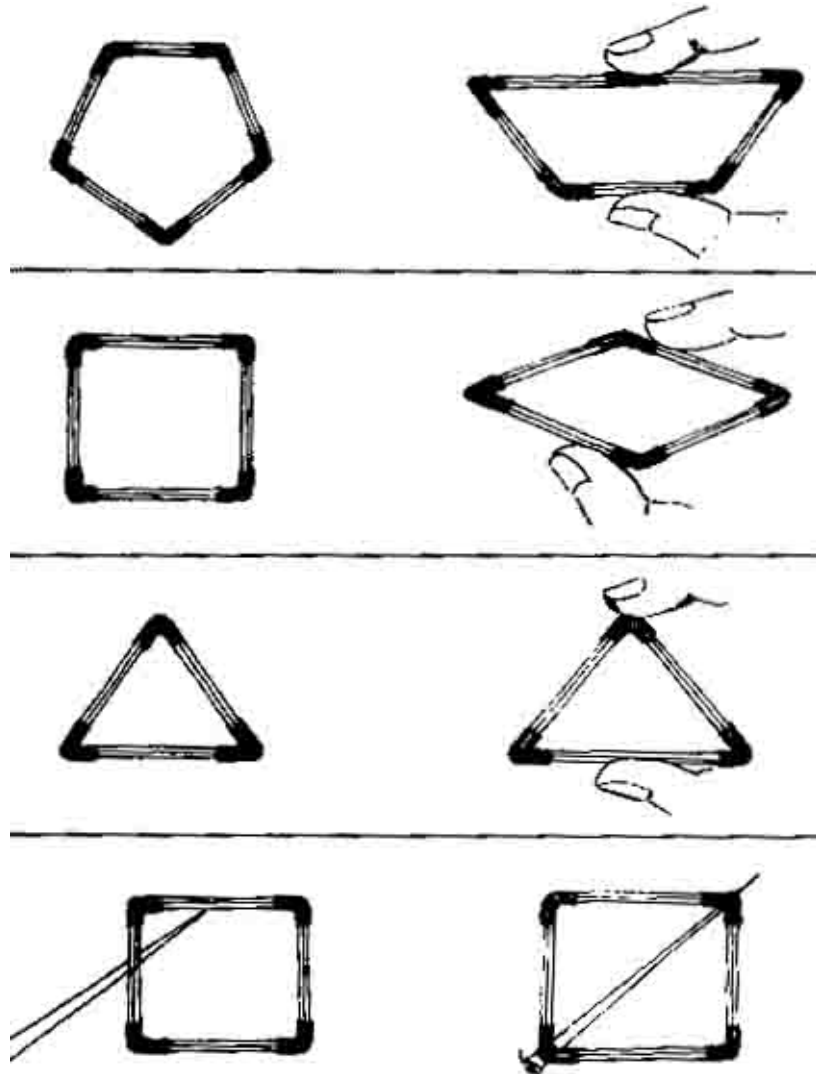

RIGIDITY OF A TRIANGLE

Try pressing a pentagon between your thumb and the middle finger. What happens?

The pentagon distorts into a boat shape.

If you hold it with both the hands and flex it, then it shakes.

It is a dancing shape.

Now press the opposite corners of a square. What happens?

The square is unable to resist the pressure.

Its right angles give way and distort into a rhombus, or a diamond shape.

Finally, try pressing or shaking the triangle. What happens? The triangle does not budge at all.

Its shape remains intact. In short, a triangle remains a triangle.

The triangle is the only rigid shape.

All other shapes like hexagons, pentagons, squares and rectangles are wobbly and shaky.

How can the square be made rigid?

Insert a long babool thorn (or a long needle) through two diagonally opposite valve tube joints of the square.

The thorn divides the square into two triangles. The triangles make the square rigid.

How can the 'dancing' pentagon be made rigid?

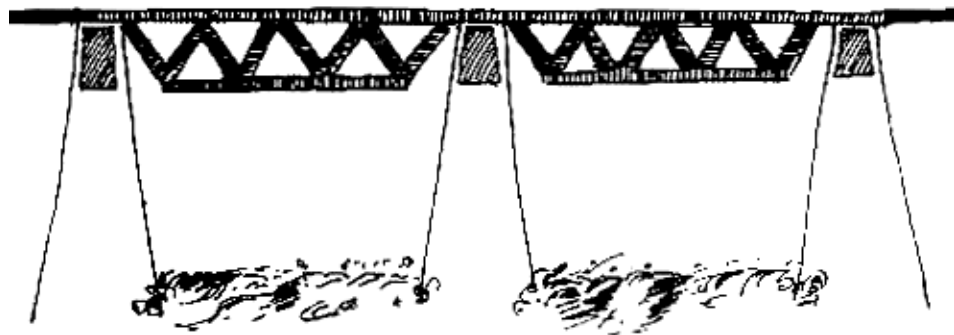
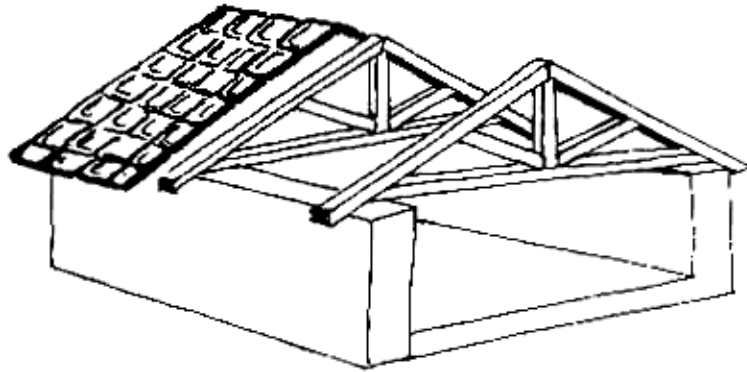

TRIANGLES IN USE

TRIANGLES IN USE

The triangle does not shake. The triangle does not distort.

The triangle is the most rigid shape.

This rigidity of triangles makes them very useful in making houses, bridges and a number of other structures, which we use, in daily life.

Most roof trusses of village houses are made of bamboo and wooden beams.

The bamboos and beams are always arranged in triangles.

The trusses are never arranged in squares, pentagons or hexagons.

What would happen if the roof truss were divided into squares?

The square truss will not be able to support the weight of the roof.

Because of the weight of the tiles, the squares will buckle into diamond shapes and the truss will collapse.

Similarly, the structural members of railway bridges and electric towers are divided into triangles.

The triangles make them rigid.

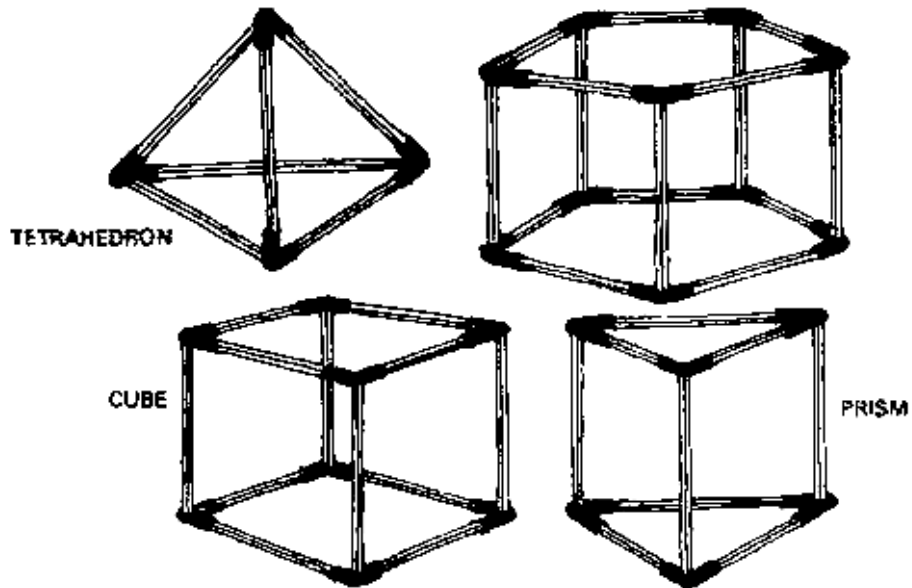
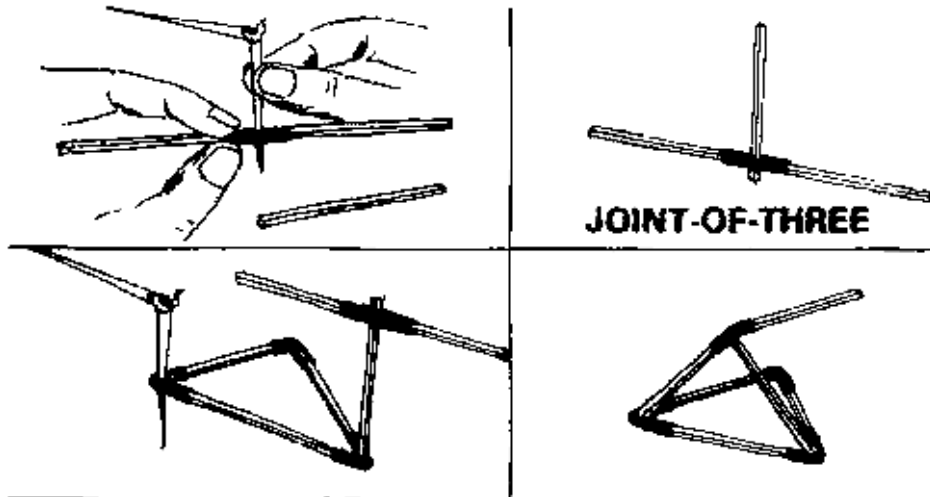

JOINT - OF - THREE

Pierce a hole in the valve tube joint-of-two by poking it at right angles with a babool thorn.
 Insert a third matchstick (slightly sharpened at the end) in this hole.

This is a **JOINT-OF-THREE**, or simply a “**T**” joint.

Take the equilateral triangle and poke holes in its valve tube joints with a babool thorn.

Now insert the three matchstick ends of the 'T' joint in the holes of the triangle.

The “**T**” joint and the equilateral triangle thus put together form a new structure.

It has 4 corners, 6 edges and 4 distinct surfaces.

All its surfaces are equilateral triangles.

As triangles are rigid so, a structure built entirely of triangles must be very rigid too.

And indeed it turns out to be true.

This structure is called a **TETRAHEDRON**

and is one of the most fundamental structures found in nature.

In a similar manner join together two separate triangles using three matchsticks to make a **PRISM**.

Joint two separate squares with 4 matchsticks, to make a **CUBE**.

Make many more structures using the joint-of-three.

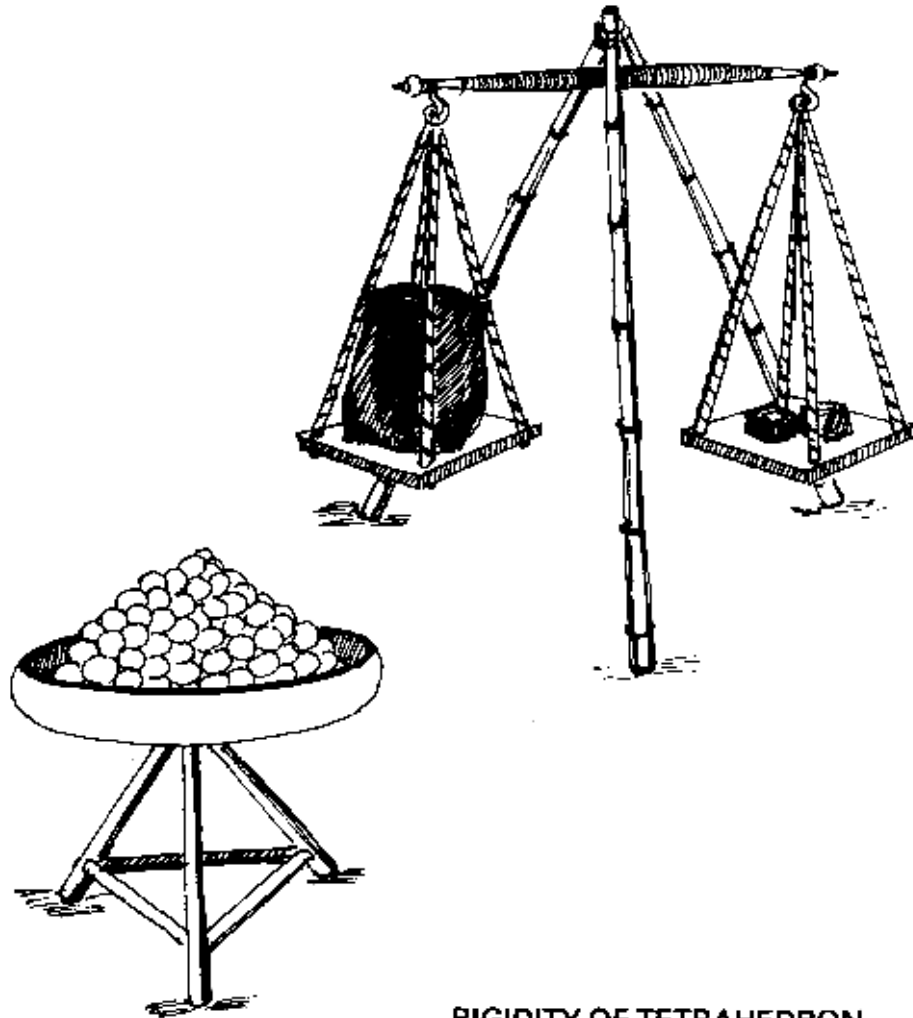

RIGIDITY OF TETRAHEDRON

RIGIDITY OF A TETRAHEDRON

The tetrahedron is the strongest structure found in nature. It has several uses in daily life.

Actually, common people have been using the tetrahedron for centuries in different kind of structures.

For instance, you must have seen grain bags being weighed in the market.

Often the weighing balance is suspended on a tripod of three bamboos.

This tripod has a structure of a tetrahedron.

Hawkers often display their wares on trays, which are kept on bamboo tripods.

You must have also seen three-legged camera tripods and stools.

These are just a few examples of the use of tetrahedrons.

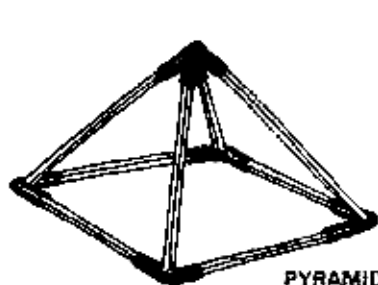
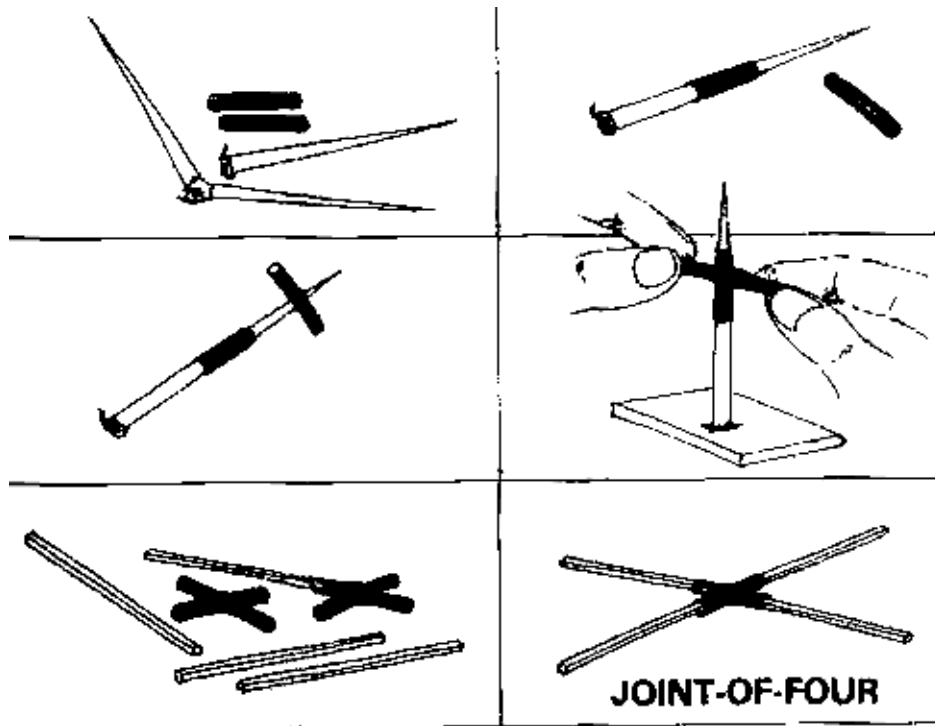

PYRAMID



OCTAHED

JOINT OF FOUR

Cut two pieces of valve tube each about 2-cm long.

Weave a babool thorn through the hole of one valve tube.

The babool thorn acts as a spindle and provides rigidity to the rubber valve tube.

Now, pierce the babool thorn at right angles in the middle of the second valve tube.

Pull both the ends of the second valve tube so as to slightly cut the rubber in its center.

Now hold the thorn vertically and rest its thick end on the door.

Pull both the ends of the second valve tube (this makes the hole in the center stretch) and slide it over the first valve tube.

Gently remove the valve tube cross-joint from the babool thorn.

This is a JOINT-OF-FOUR, or simply a "X" joint.

Fix four matchsticks in this "X" joint.

Pick up the square you had made earlier. Poke holes in its valve tube joints with a babool thorn.

Insert the four matchstick legs of the "X" joint in these holes.

This new structure is called a **PYRAMID**.

Its apex is a joint-of-four.

Two pyramids can be put back-to-back with their square bases mating, to make an octahedron.

Use six cross-joints and twelve matchsticks to make an **OCTAHEDRON**

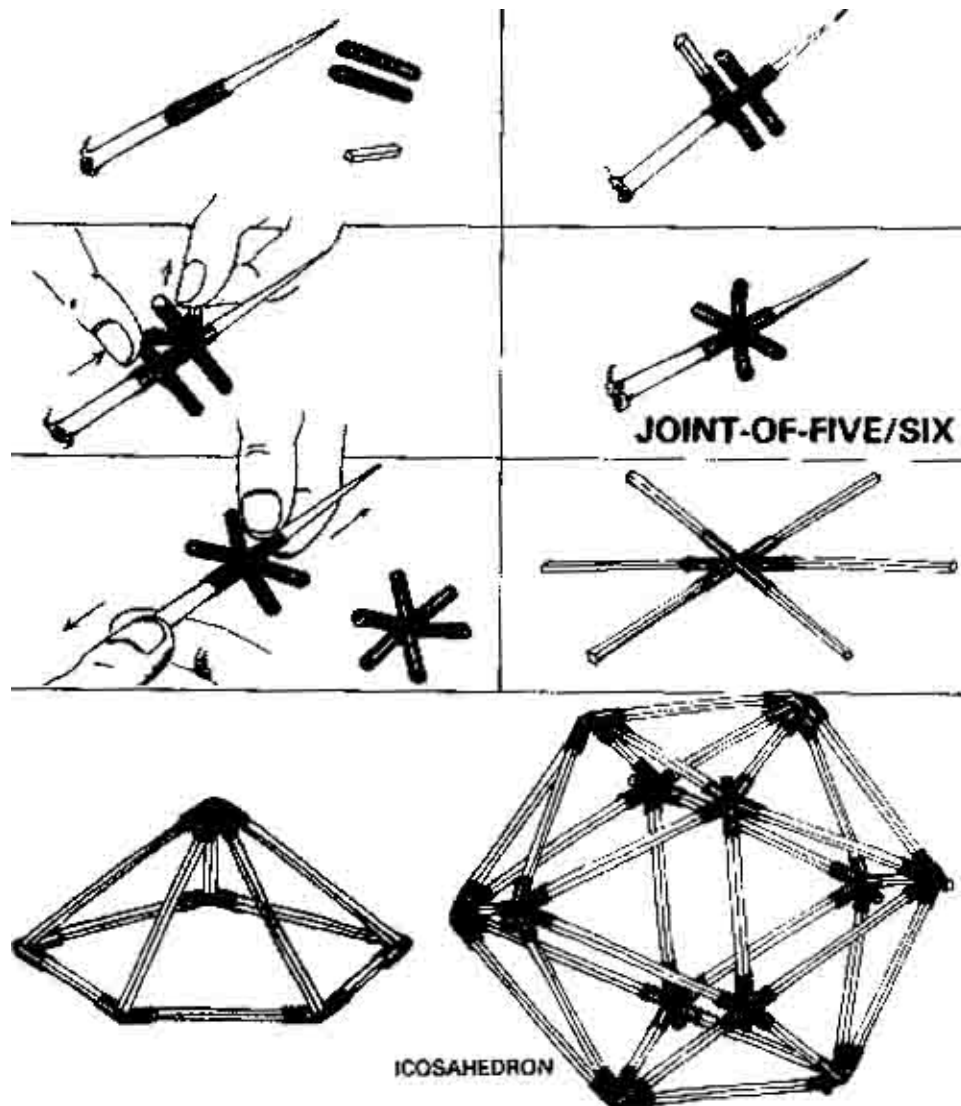

JOINT - OF - FIVE/SIX

Make a joint - of - four but do not remove it from the babool thorn.

Like the second valve tube insert a third valve tube on the first valve tube.

The second and the third valve tubes are at right angles to the first valve tube.

Thus we get a "H" shape. Insert a small piece of matchstick in any of the free legs of the "H". Sharpen the end of this matchstick and weave it through the center of the other leg of the "H".

After removing the babool thorn, phase out the six legs of the valve tube star so that they are approximately sixty degrees apart.

This is a **JOINT-OF-SIX**, or simply a "star" joint.

For a **JOINT-OF-FIVE**, simply cut one of the legs of the "H".

Assemble twelve joints-of-five and thirty matchsticks to make an **ICOSAHEDRON**.

The icosahedron is entirely made up of triangles and hence is very rigid.

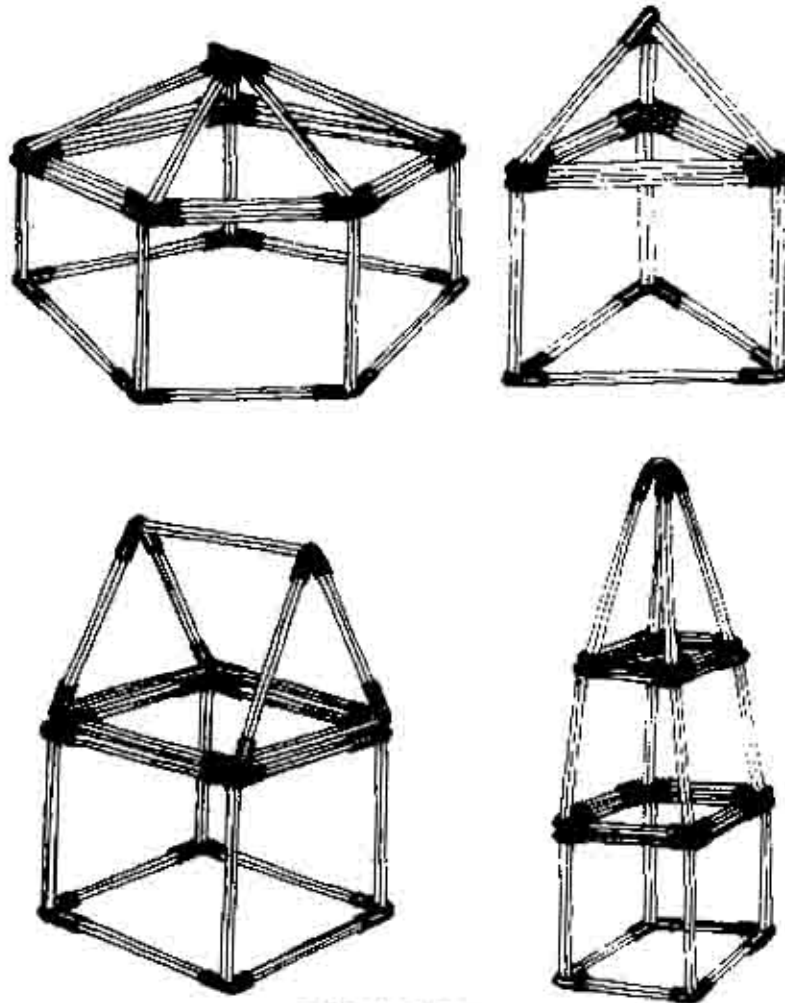

BASIC PATTERNS

BASIC STRUCTURES

Apart from the triangle there are three other triangulated, symmetric and stable structures - the tetrahedron, the octahedron and the icosahedron.

All the structures that you have made can be arranged together in different combinations to make new configurations. For example, the prism can be kept on top of the cube to make a house.

A few more examples of a tent and a temple are given. However, you can make several more combinations on your own.

**TETRAHEDRON
OCTAHEDRON COMPLEX**

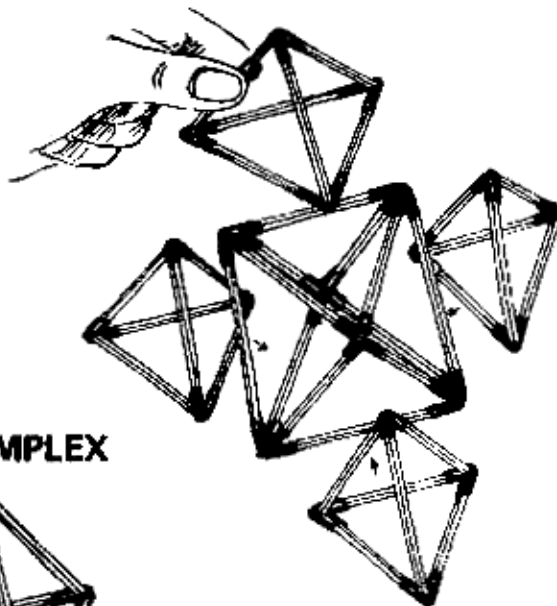
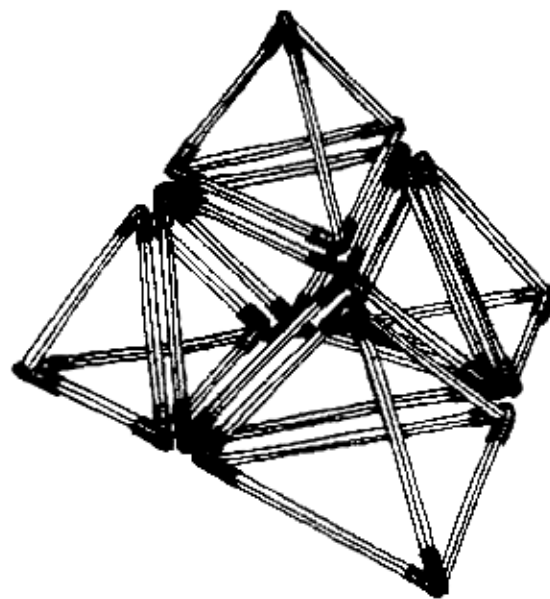

TETRAHEDRON-OCTAHEDRON COMPLEX

Tetrahedrons and octahedrons have a fascinating property.

They join together to make larger structures.

Four tetrahedrons and one octahedron assemble together to make a larger tetrahedron.

If the volume of the small tetrahedron (edge length one matchstick) is 1, than the volume of the larger tetrahedron (edge length two matchstick) is $2 \times 2 \times 2 = 8$ times the volume of the small tetrahedron.

So, the volume of the octahedron will be equal to the volume of four tetrahedrons.

For making large size models you can substitute the matchstick members with equal length broomsticks or cut pieces of cycle spokes.

MOLECULAR STRUCTURES

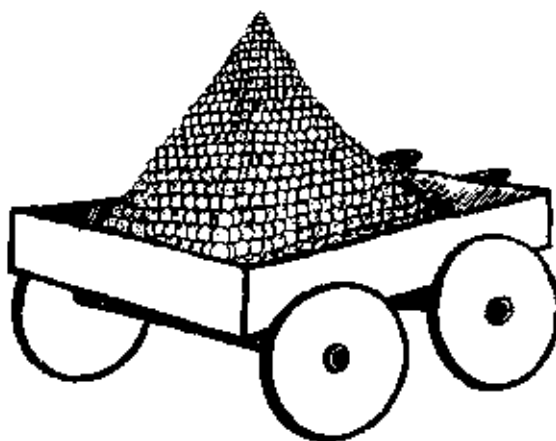
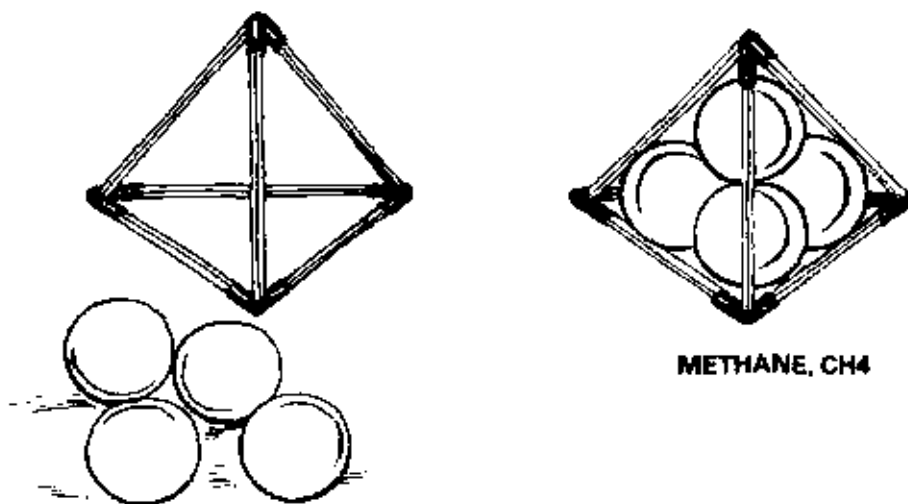

MOLECULAR STRUCTURES

A number of simple molecular structures can also be made using the matchstick - valve tube mecano.

For instance, four marbles can be easily inserted into the tetrahedron.

It results in simulating the molecular structure of Methane – which is a major constituent of “gobar – gas”.

The chemical symbol of Methane is CH₄.

Here the four atoms of Hydrogen are at the Four Corners of the tetrahedron and the lone Carbon atom lies snugly in the space between them.

You must have noticed the stacking of spherical 'laddoos' and oranges.

How are these spheres stacked?

Nature also adopts close packing techniques - it tries to pack in the maximum amount of material in the minimum amount of space.

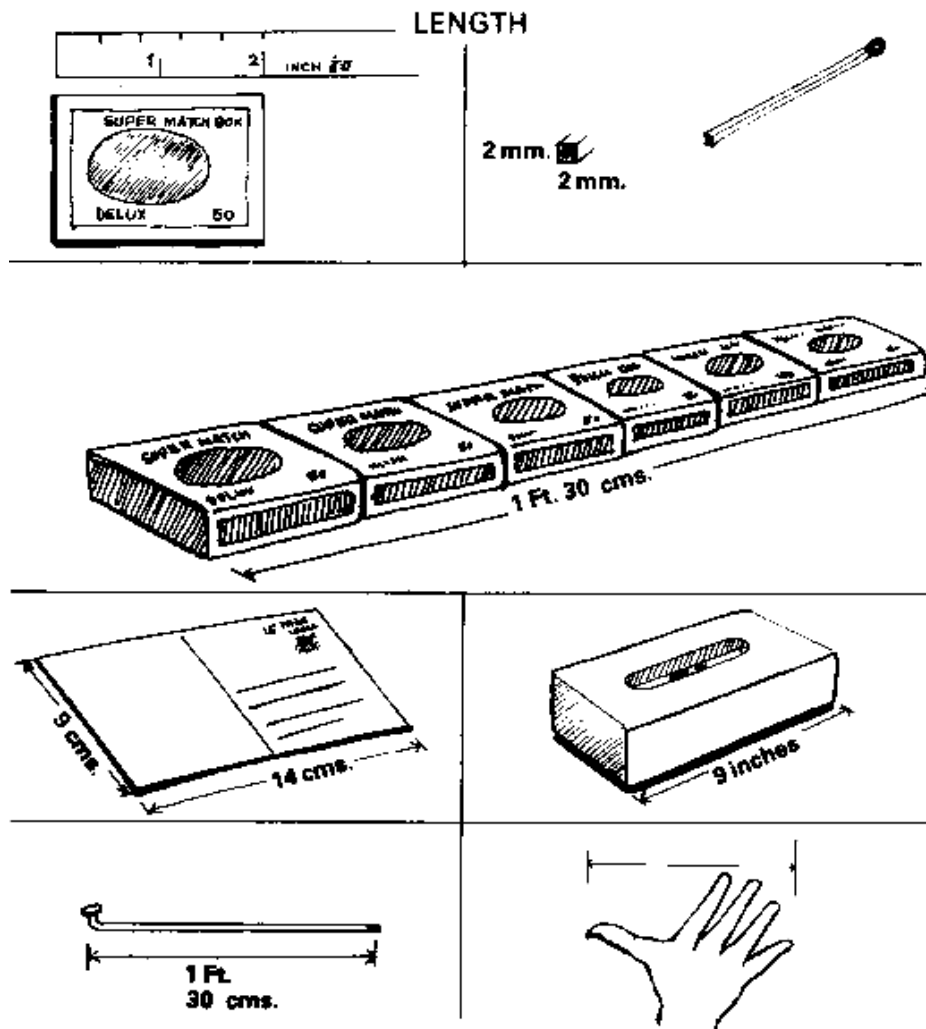

MATCHBOX MEASURE

A matchbox is readily available. It is an inexpensive item of daily use. Matchboxes are daily produced in millions. Because the matchbox is mass-produced in a factory, its size and dimensions conform to certain standards. Let us discover some of the dimensions of an ordinary matchbox.

LENGTH

The length of a matchbox is a good estimate of 2 inches, or 5 centimeters.

It can be used for estimating length. Half a matchbox would measure 1 inch, or 2.5 cms.

The length of six matchboxes kept end-to-end would almost be 1 ft., or 30 cm.

Like the matchbox there are several other common objects, which can be used as good estimates for measurement of length.

Every matchstick has a square cross-section. Each side of the square measures 2 mm.

The postcard is always 14 cm long and 9 cm broad.

Normal bricks are 9 inches long.

The length of a cycle spoke is approximately 1 ft., or 30 cm.

Coins have standard dimensions.

They can be used as pretty good estimates for measurement of length.

For instance, a circle drawn around a 50-paisa coin is almost 1 inch, or 2.5 cm in diameter.

You must verify the lengths of the above items for yourself by actually measuring them with a scale.

Later on, even if you do not have a ruler at hand, you can always use some matchboxes, coins, postcards etc for making estimates of length. Measure the length of your hand-span.

AREA

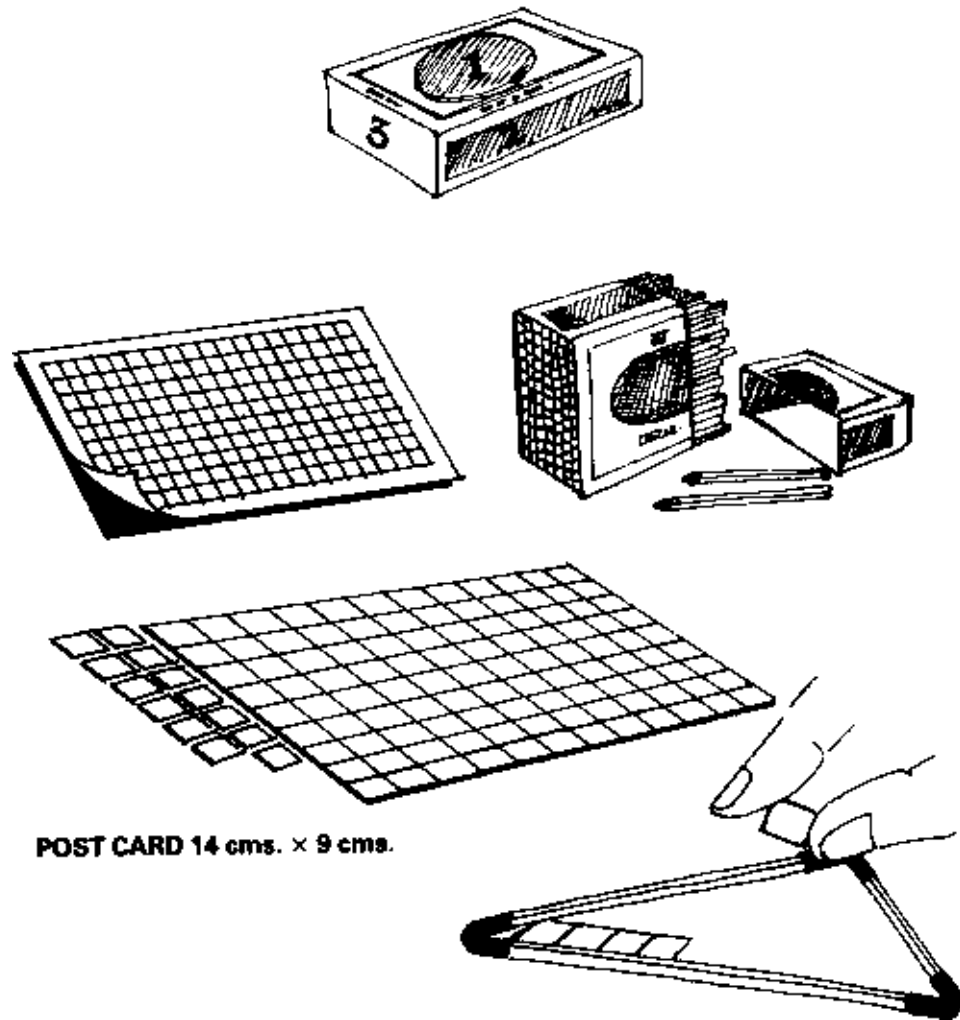

POST CARD 14 cms. \times 9 cms.

AREA

A matchbox has three distinct surfaces the labeled surface (1), the strike surface (2) and the drawer surface (3).

Which is bigger, the labeled or the strikes surface (1) or (2)?

Why is (1) bigger than (2), when both of them share a common length?

Which is bigger, the strike or the drawers surface (2) or (3)?

Why is (2) bigger than (3) when both share a common breadth?

How to find the area of the outer shell of the matchbox?

One way of course, is to measure the length and the breadth and to multiply it.

There is however, another interesting way of finding out the area.

Matchsticks have a square cross-section measuring 2 mm. \times 2 mm.

Burnt matchsticks can be used as standard bricks, for measurement of area. Pack burnt matchstick 'bricks' in the outer shell of a matchbox to construct a wall.

The area of each standard "brick" is already known.

By counting the total number of matchstick "bricks" used, you can estimate the area of the matchbox shell.

Cut a postcard - 14 cm \times 9 cm into one-centimeter squares.

Use these unit squares to estimate the area of any shape.

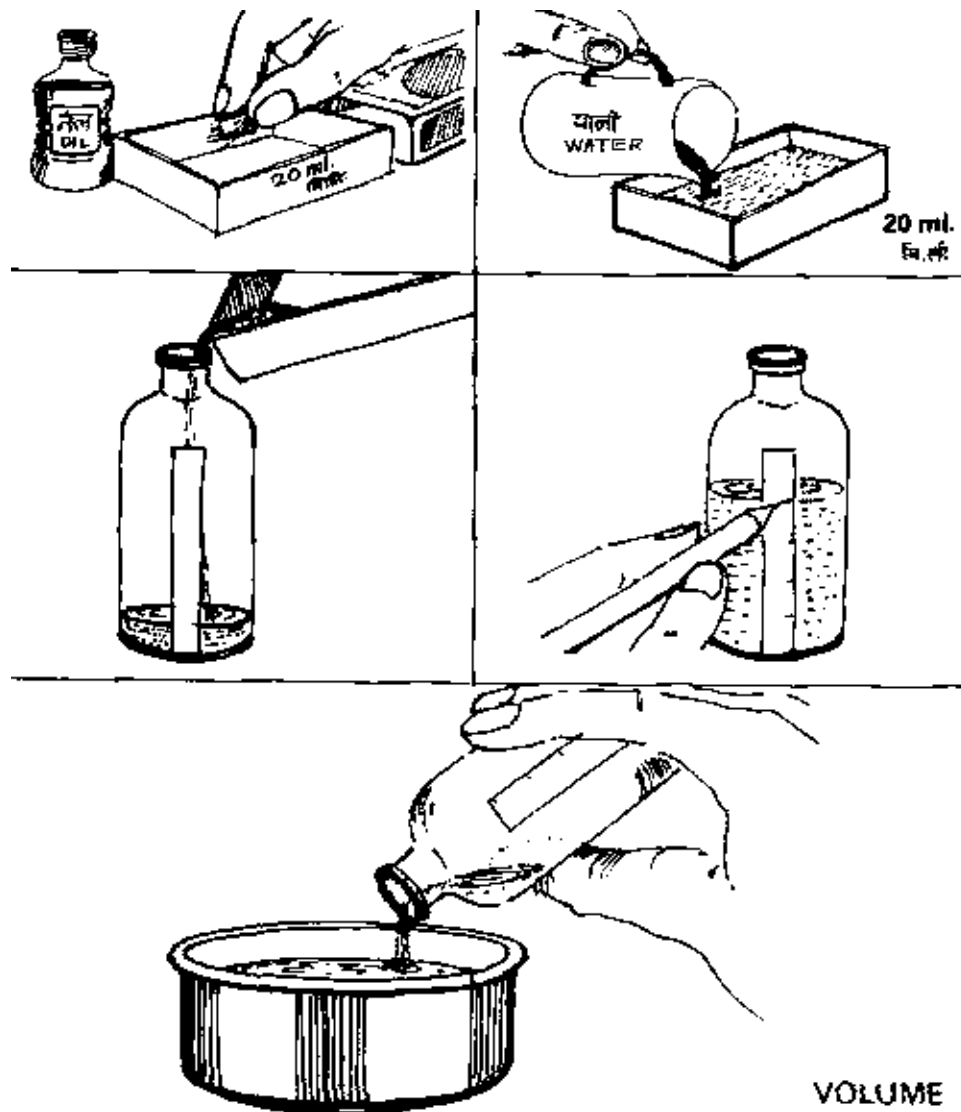

VOLUME

VOLUME

Dip a little cotton ball in oil and rub it on the matchbox drawer. Soon the wood and the paper of the matchbox drawer will absorb the oil. Keep the drawer in the sun for drying. Oiling makes the drawer waterproof. This drawer when filled with water holds approximately 20 milliliters of water.

The matchbox drawer is a good estimate for measuring 20 ml.

You can use this as rough standard for measuring volume.

Stick a strip of white paper along the length of a broad-mouthed bottle.

Now, fill a matchbox drawer with water and pour it in the bottle.

Indicate the water level in the bottle by marking a line on the strip of paper.

This mark will indicate 20 ml.

Add further drawers full of water in the bottle, and each time keep marking the levels of 40 ml., 60 ml., 80 ml., 100 ml. etc.

You can draw a line midway between the 40 ml. and 60 ml. marks.

This midway line will indicate the 50 ml. mark.

This bottle now becomes a graduated cylinder for measurement of volume.

Fill the bottle unto the 100-ml. mark, and then pour it out in bucket. Repeat this ten times.

Now the water in the bucket will be 1,000 ml. or 1-liter of water.

WEIGHT

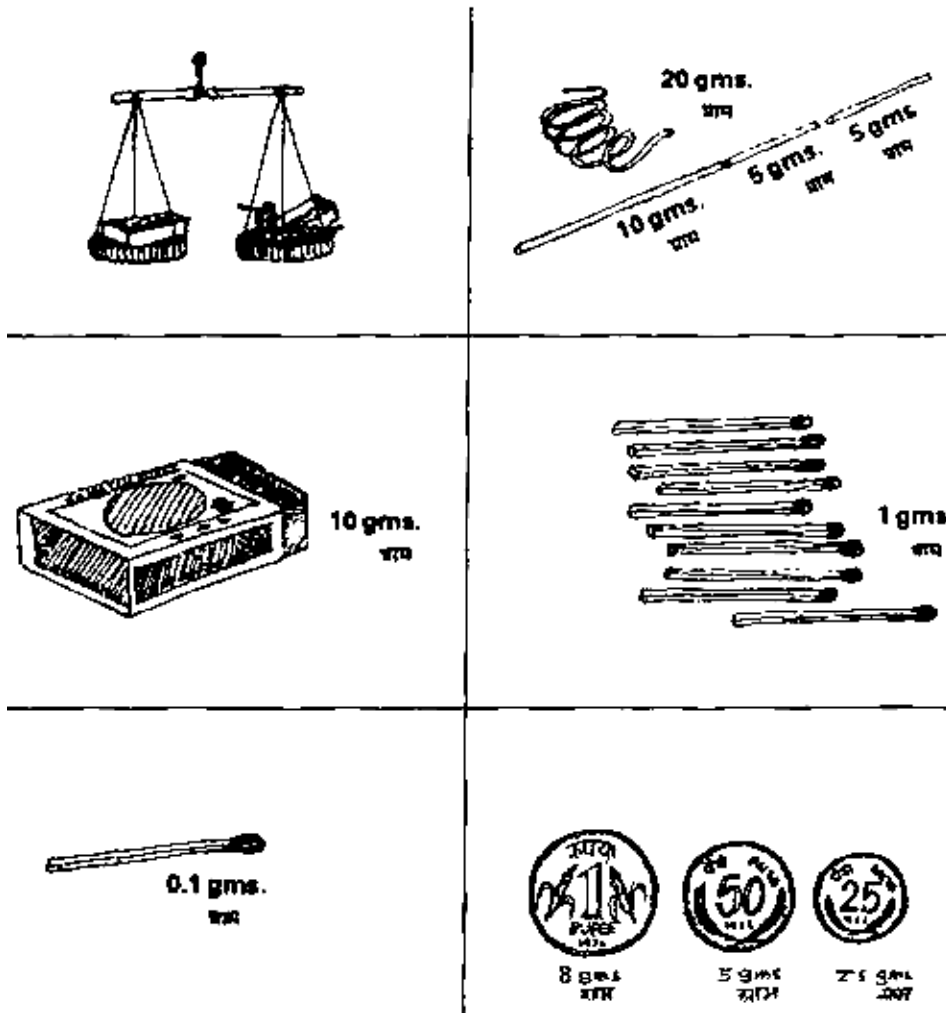

WEIGHT

Make a weighing balance using leaf cups or empty polish tins for the pans.

Ensure that the balance point is equidistant from the two pans.

Only then will the balance weigh truly. Now keep one oiled matchbox drawer on each of the pans.

As the drawers have the same weight the beam will remain horizontal.

Fill the left-hand drawer completely with water. The drawer will hold 20 ml. of water.

And as one milliliter of water weighs one gram (density of water) so, 20 ml. of water will weigh 20-gms.

It amounts to putting a 20-gms weight in the left-hand pan.

Place some junk wire in the right hand pan so as to balance the beam. The wire shall now weigh 20-gms.

Straighten out the wire and cut it into half and quarter lengths to make 10-gms and 5-gms weights.

You can similarly make 50-gms and other weights.

Several daily use objects have standard weights.

A brand new sealed matchbox is a good estimate for 10-gms.

50 unburned matchsticks approximately weigh 5-gms.

10 unburned matchsticks approximately weigh 1-gm.

1 unburned matchstick is a very good estimate of 0.1-gms.

The approximate weight of some of the coins is:

One Rupee coins (old) 8.0-gms.

One Rupee coin (new) 6.0-gms.

50-Paise coin (old) 5.0-gms.

25-Paise coin (old) 2.5-gms.

BABOOL THORN DIVIDER

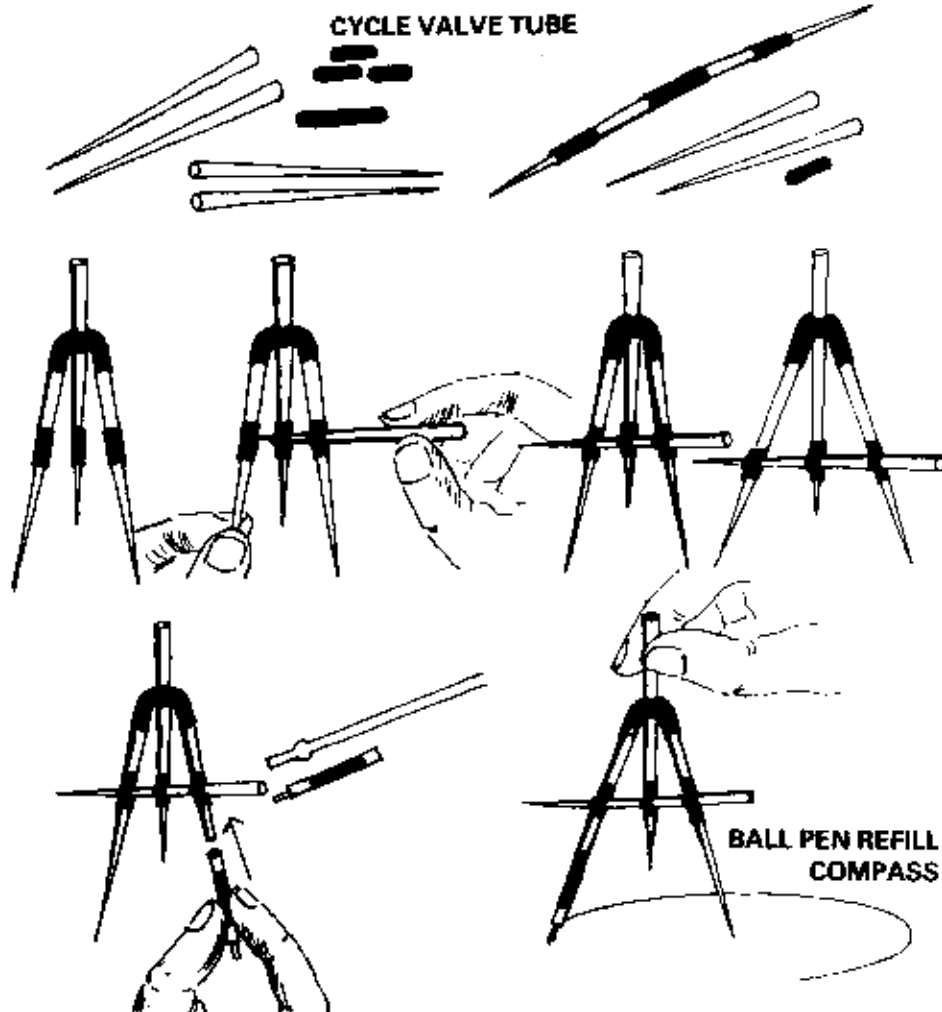

BABOOL THORN DIVIDER

Take four long babool (*Acacia arabica*) thorns of almost equal length. Join the thick ends of two babool thorns with a piece of cycle valve tube to make a tweezers.

Slip a small piece of valve tube on each leg of the tweezers.

Insert a third babool thorn through the valve tube in the tweezers joint to make the handle of the divider.

Poke the fourth babool thorn, as a cross-member, through the valve tube pieces of the tweezers legs.

The distance between the legs of the divider can be increased or decreased by sliding the legs on the cross-member.

The sharp points of the babool thorns make a fine divider.

The babool thorn divider can also be converted into an ink compass.

Break one leg of the divider and insert a small piece of ball pen refill in it.

This compass can be used for drawing ink circles.

BUTTON PULLEY

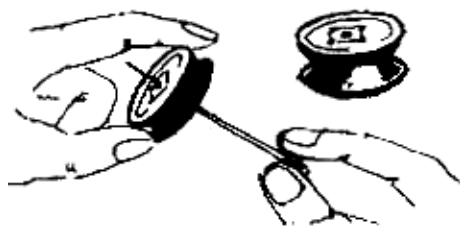
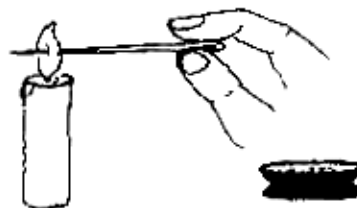

BUTTON PULLEYS

Pulleys are used on wells, pulley blocks and on cranes.

Pulleys help us to lift heavy loads with the help of less force.

Here is a simple way of making lightweight, efficient and low-cost pulleys.

Buy some cheap quality plastic buttons.

It is necessary to have cheap quality plastic buttons, which melt with a hot needle.

Put two coat/pant buttons back-to-back with their convex surfaces mating.

Match the holes of the two buttons and then sew them together with a needle and a thread.

Take care to sew the buttons in the form of a square.

Do not take cross-stitches as this will blank out the center.

Now make a hole through the center of the two buttons by using the tip of a hot needle.

Make the bore smooth until the button pulley rotates freely.

To make a hanger for the pulley open up a paper clip into a "S" shape.

Bend one leg of the "S" at right angles.

Slip in the button pulley in the horizontal leg of the paper clip hanger.

Put a cycle valve tube stopper to prevent the pulley from slipping out.

The hook in the hanger is used for suspending the pulley by a nail.

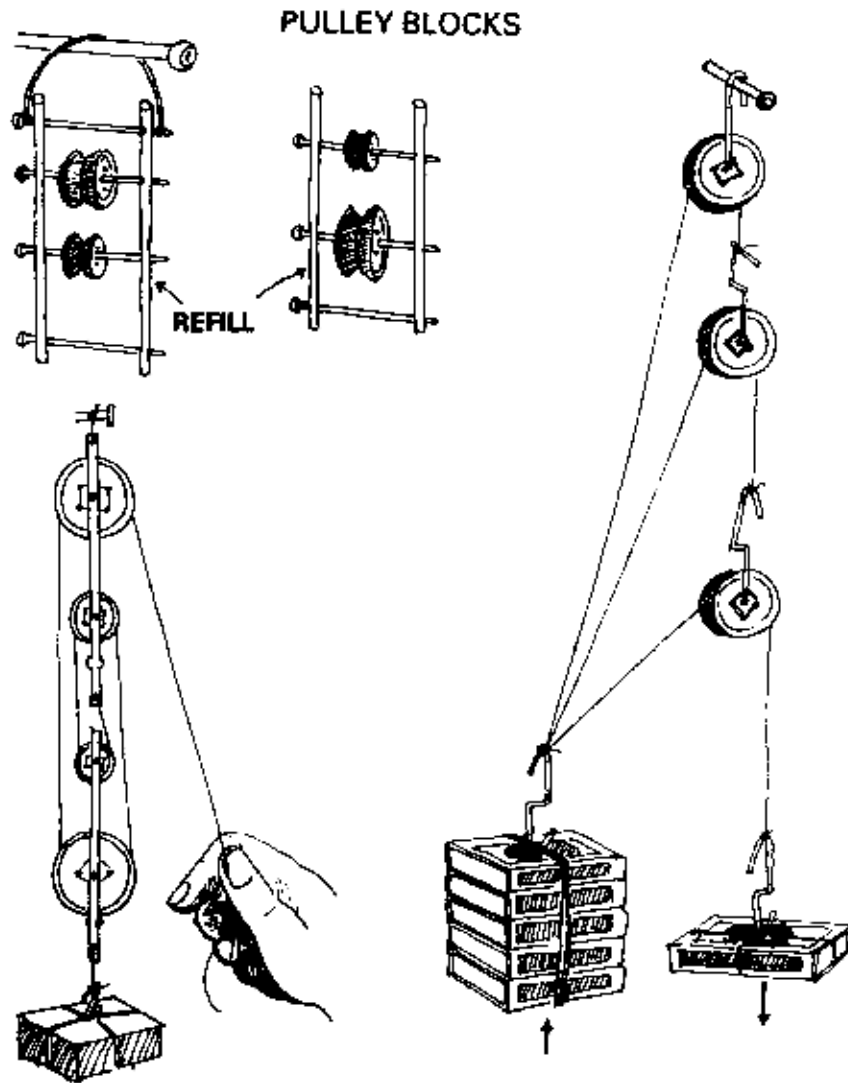

PULLEY BLOCKS

Different sizes of cheap quality plastic buttons
can be used to make different sizes of pulleys.

Several big and small pulleys can be assembled into pulley blocks.

Make a ladder shape hanger for hanging the pulleys.

Use empty ball pen refills for the long members and paper pins
for the short members of the ladder.

With the help of these pulley blocks you can lift heavy loads by applying less force.

Assemble three pulleys and three separate strings in a configuration shown in the picture.

Put 5 new matchboxes (50-gms) on the load end.

Now, put one new matchbox (10-gms.) at the effort end.

You will be surprised to find that one matchbox is able to lift up a load of five matchboxes.

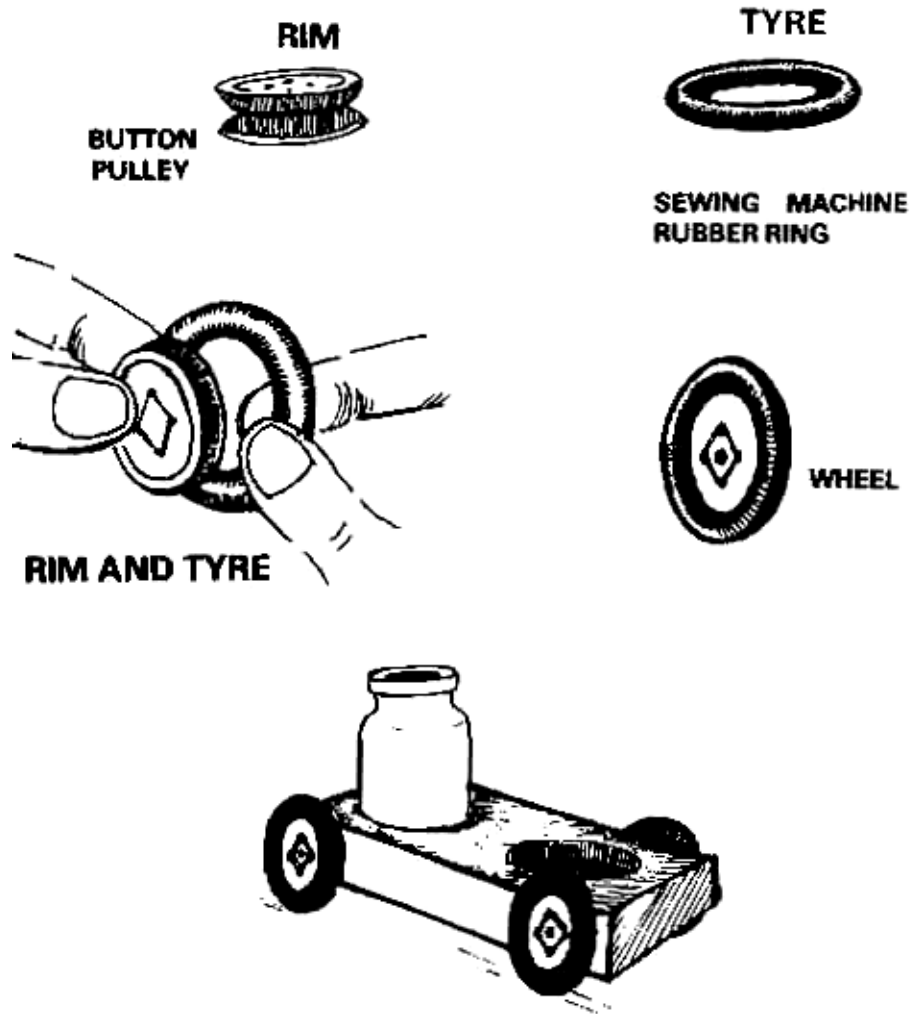

RIM AND TYRE

You must have seen the black rubber ring used in home sewing machines.

This rubber ring rubs against the big flywheel, and rotates the bobbin spool for filling it with thread.

You can make a nice rubber wheel using the coat button pulley and this rubber ring.

The button pulley acts as a rim, and the rubber ring slips on it like a tyre.

With bit of practice you can make very professional wheels.

You can use these wheels for making trolleys and cars of various kinds.

They can also be used as very smooth undercarriage wheels in aeromodels.

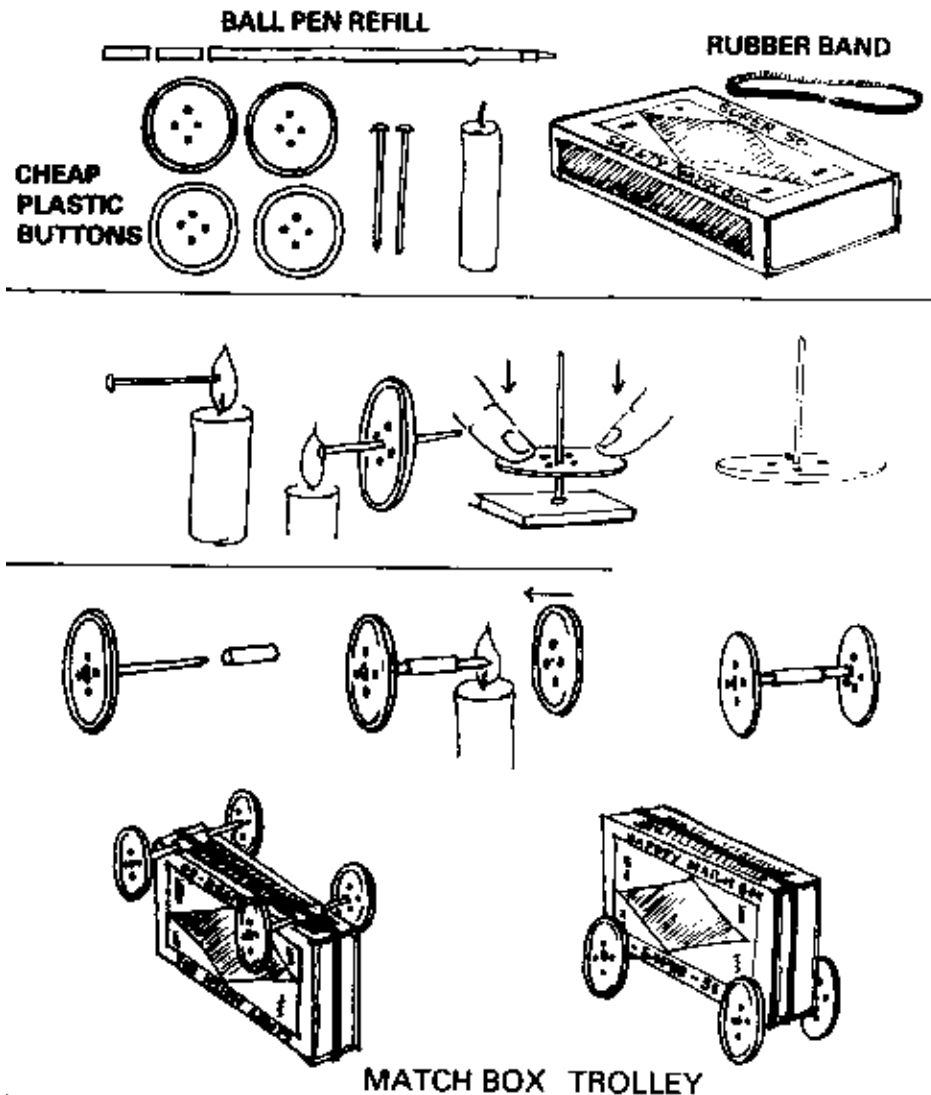

MATCHBOX TROLLEY

Heat the tip of a paper pin and pierce it through the center of a cheap quality plastic coat/pant button (the sort you used for making pulleys).

Now heat the head of the pin.

Apply pressure on the rim of the button with your thumbs and press the hot pinhead against the ground.

The pinhead goes and firmly embeds itself in the center of the plastic button.

If however, the pin comes out at an angle, it can be made square (at right angles to the button) while it is still hot and pliable.

The pinhead firmly anchored in the center of the button makes a good 'drawing pin'.

Now, cut and insert a small piece of used ball pen refill in the 'drawing pin'.

The refill will serve the purpose of a bearing or a 'bush'.

Heat the tip of the 'drawing pin' in a candle flame once again and embed it in the center of another cheap quality plastic button.

This assembly consists of two button wheels, one paper pin axle and a ball pen refill bearing.

Make two such wheel assemblies. Place a new matchbox on their refill bearings.

Put a rubber band around to anchor the wheels to the matchbox.

With the help of the matchbox trolley you can do a whole range of experiments in dynamics, like the roll-and-drag friction experiment, inclined plane experiment etc.

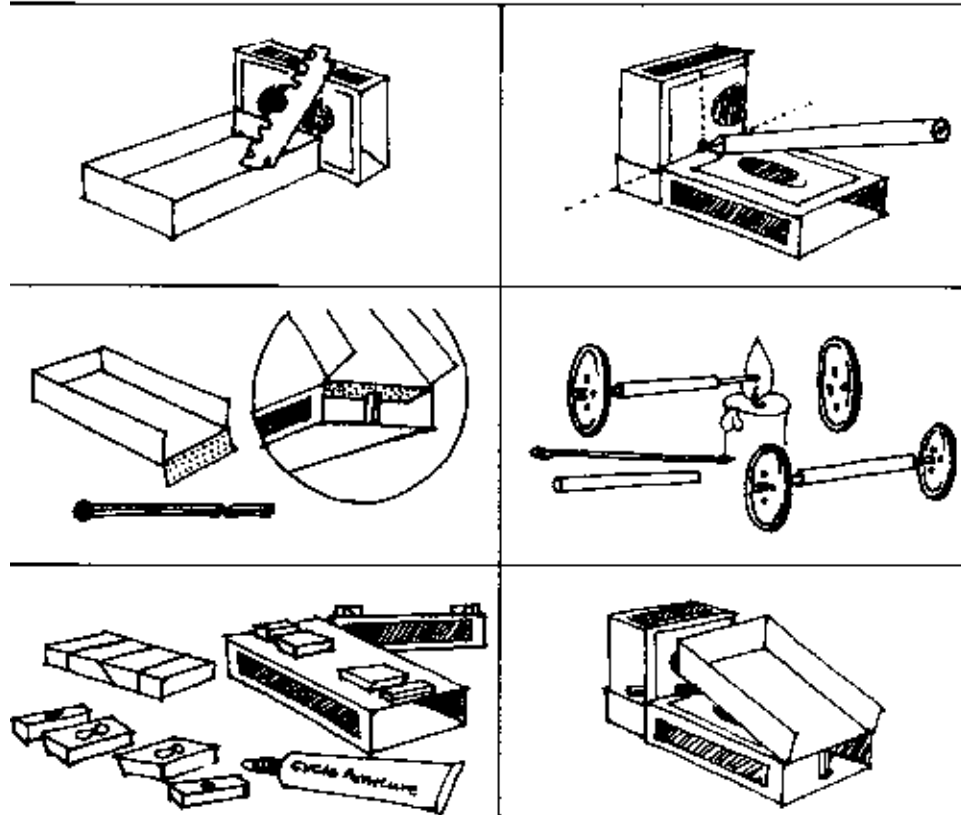
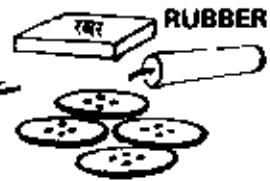
PUNCTURE SOLUTION**MATCH BOX****TIPPER TRUCK****MATCHBOX TIPPER TRUCK**

You must have seen tipper trucks unloading sand, stones or coal.

You can readily make a working model of a tipper truck.

Take a matchbox and separate its drawer from the outer shell.

Cut the outer shell so that it fits into the drawer.

The cut shell becomes the driver's cabin. Make a hole in the driver's cabin.

Slip another matchbox outer shell on this drawer. This will make the body of the tipper.

Take another drawer. Cut and bend its tongue into the body of the truck.

You can either stick this tongue inside this body, or it can be wedged with a piece of matchstick.

The drawer can now swivel on the body and make the loading platform of the dump truck.

Make two pairs of wheels using buttons, needles and refills.

Cut a rubber eraser into four pieces. Stick these pieces in two pairs below the body.

The distance between each pair should be equal to the thickness of a ball pen refill.

Fix the wheel pairs between the rubber pieces.

Insert a matchstick from the hole in the driver's cabin. Load some pebble cargo in the tipper truck.

On pressing the matchstick lever from inside the driver's cabin,
the loading platform will be raised to unload the cargo.

On pushing it the tipper truck will run very smoothly.

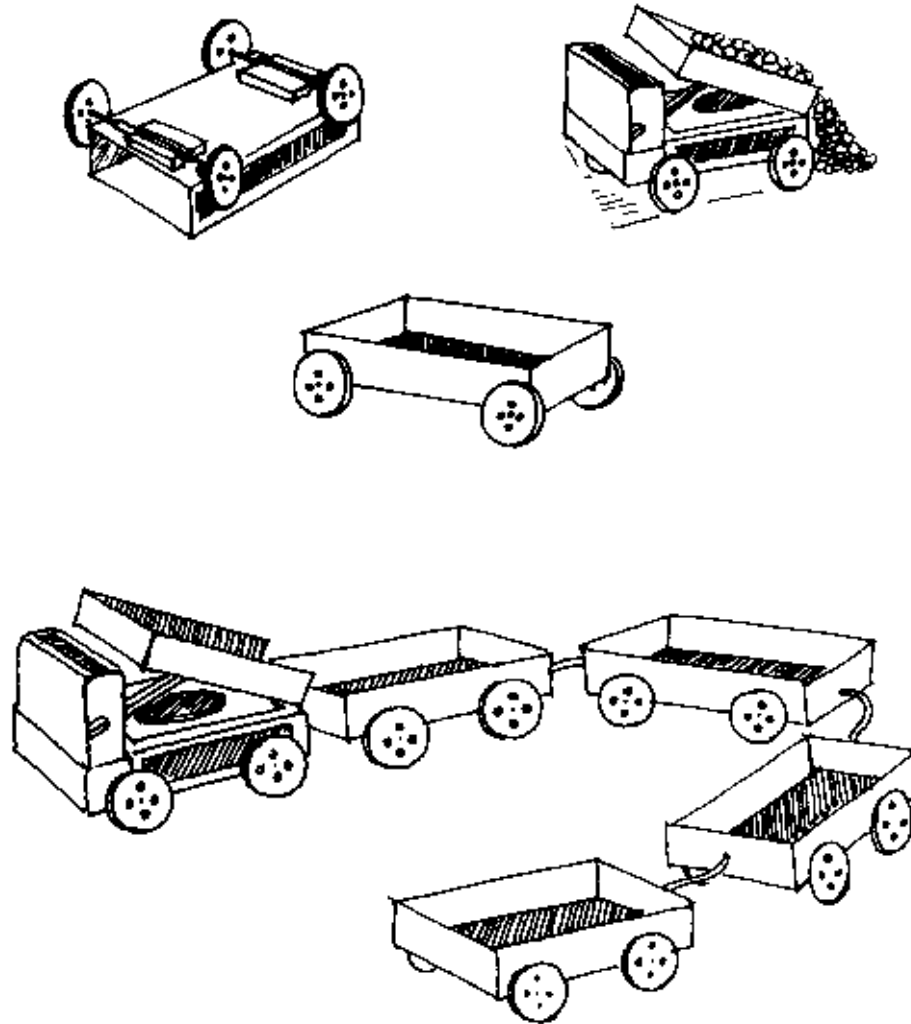

TIPPER AND TRAILER

The matchbox tipper is an illustrious example of children's creativity.

It was designed by the children of contract worker's in the iron-ore-mining township of Dalli-Rajhara (Madhya Pradesh, India).

Most of these children do not go to school, but every day they see hundreds of dump and tipper trucks carting ore from the mines to the railway station.

An urge to imitate the adults must have prompted the children into designing this model marvel of the tipper truck using just two matchboxes.

Matchbox drawers can be similarly converted into wagons on wheels. Several such wagons could be coupled together to trail behind the tipper truck.

BATTERY ENGINE

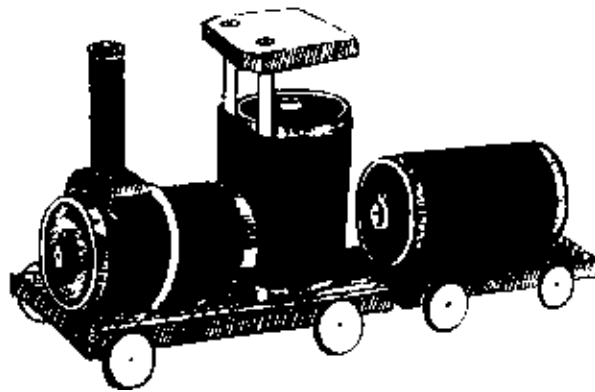
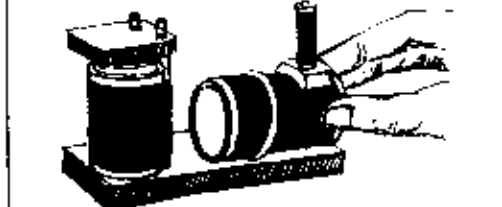
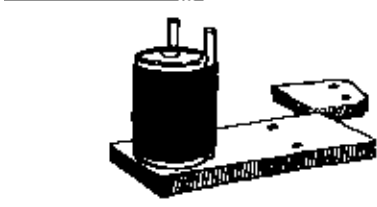
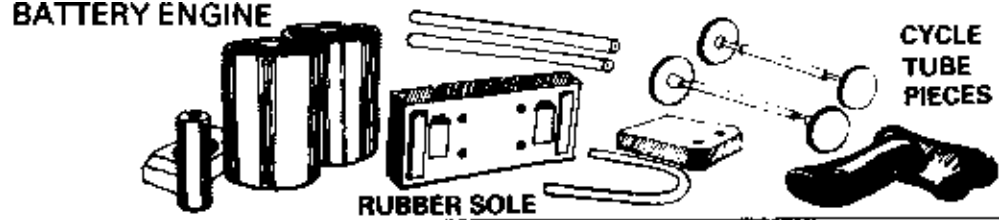

BATTERY ENGINE

Collect 2 used torch batteries and a pencil cell.

Cut two pieces from an old cycle rubber tube equal in size to the height of the batteries.

Slide the cycle tube pieces on the batteries.

Cut a 2.5cm square from an old rubber shoe sole.

Make a hole in this piece so as to fit the pencil cell.

Stick this square rubber piece on top of the cycle tube of one battery with cycle puncture solution.

The battery becomes the boiler and the pencil cell becomes the chimney.

Cut 5cm x 12 cm of shoe sole rubber for the engine base.

Make two holes in the engine base and lie the boiler and chimney assembly to it.

Insert two broomstick pieces or pencil stubs in between the other battery and the other tube.

Make two more holes in the engine base and fur the pencils in it.

This becomes the driver's cabin.

Fix a rubber canopy on top of the driver's cabin.

Fix two pairs of button – needle bullpen refill wheels to the bottom of the rubber base.

You can make a tanker wagon using a single torch battery.

Assemble the engine and the tanker into the train.

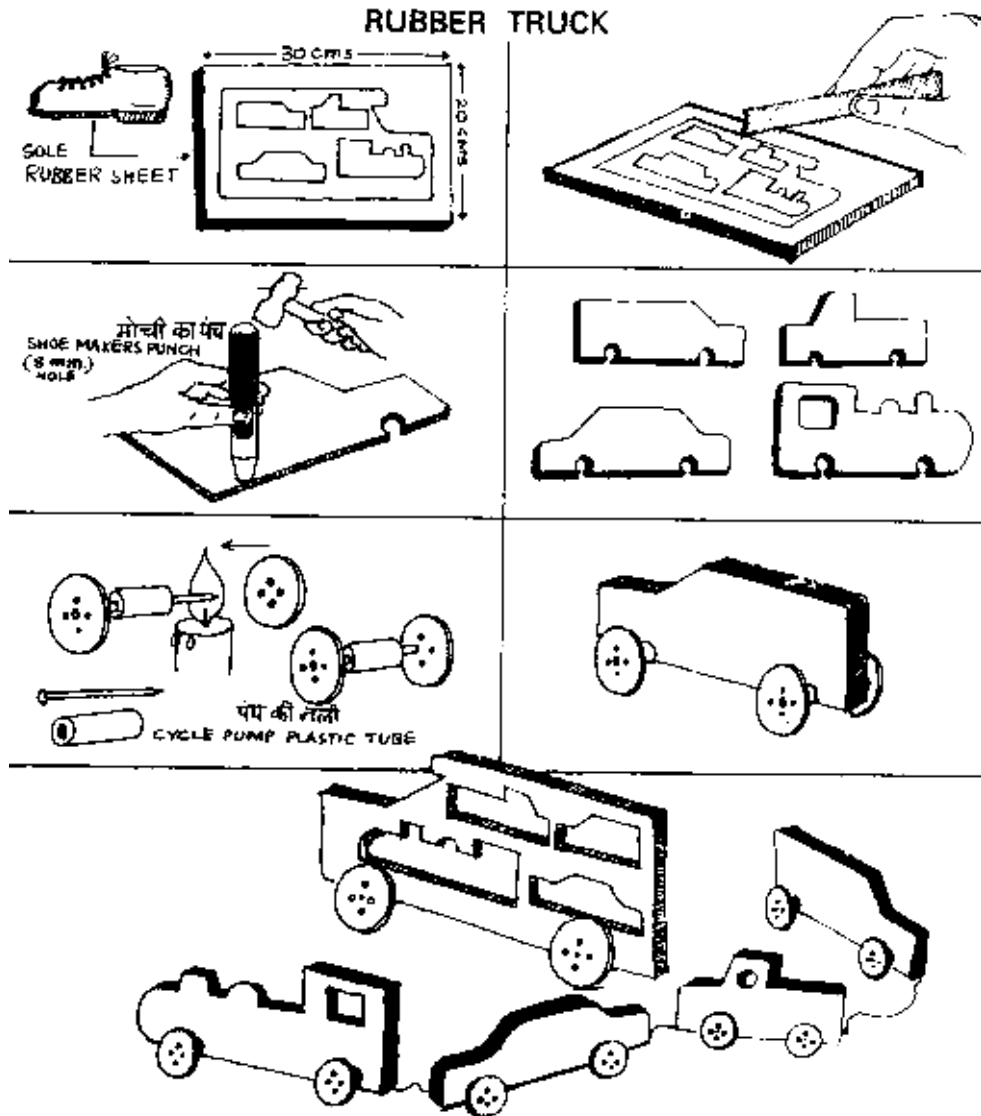

MOTHER TRUCK

Take a 20-cm x 30-cm piece of shoe sole rubber (about 8 mm thick).
Mark out different models of vehicles - engine, car, jeep and van on it with a ball pen.

Cut these shapes with a sharp knife.

With a shoemaker's punch make two holes near the base of each vehicle.

Now make several button-wheel pairs.

Instead of ball-pen refill bush bearings, use 1.5-cm long pieces of cycle pump pipe.

These plastic pipes will snap in the holes of the rubber vehicles.

You can fix or remove the wheels at will.

Remove the small vehicles from the big mother truck.

Fix the wheels to the vehicles and make them run.

Join all the vehicles into a train.

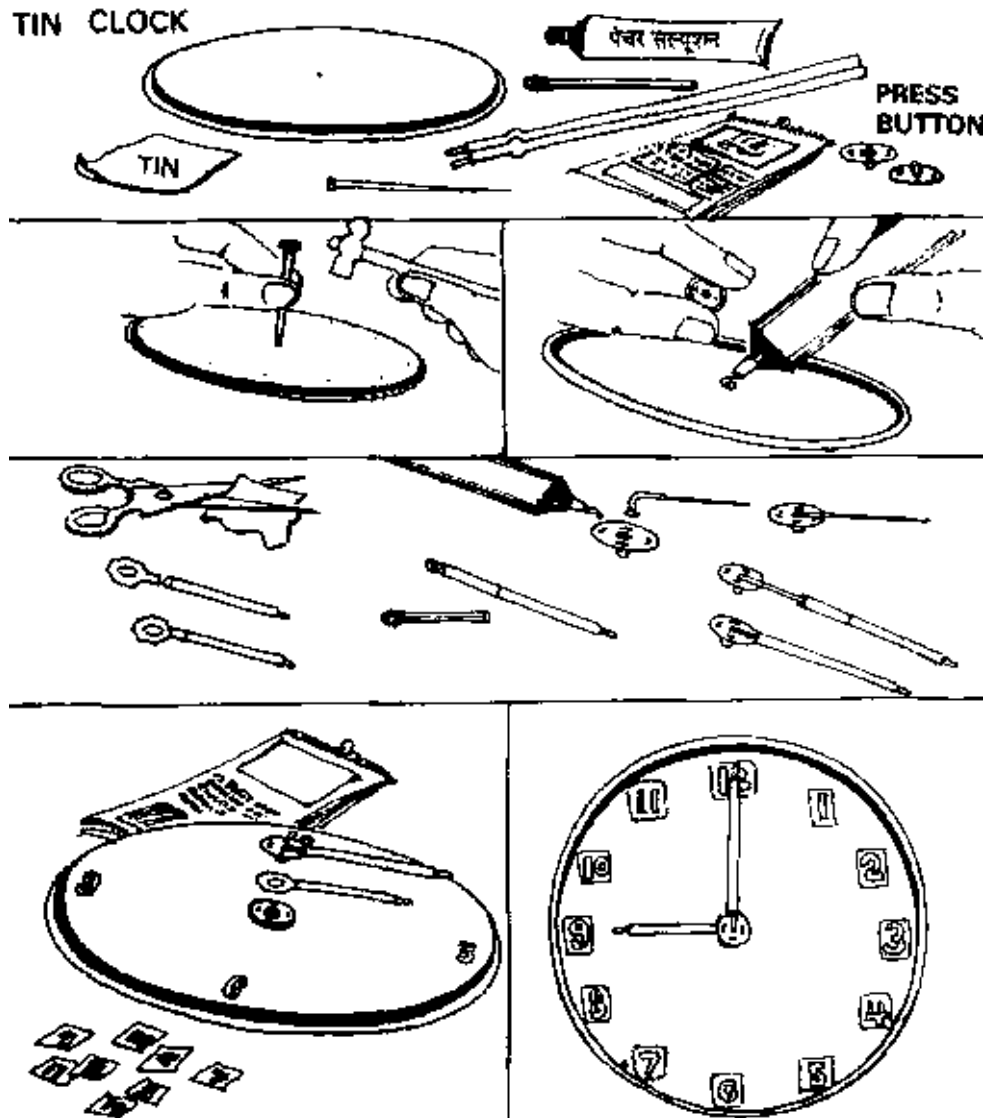

TIN CLOCK

Take the circular lid of an old tin box.

Make a hole in its center with a nail.

Stick one half of a big press-button in this hole with some adhesive.

Bend the head of a paper pin at right angles.

Insert this head into the depression in the other half of the press-button and apply some adhesive.

Soon the pin will become integral with this half of the press-button.

Insert the pinpoint in a refill using a piece of matchstick as the wedge.

This becomes the minute's hand of the clock.

Cut an 8-mm.-diameter circle out of an aluminum foil.

Punch a hole in its center, and cut a little tongue in its rim.

Insert a small plastic refill in this tongue.

This becomes the hour hand of the clock.

Cut numbers from 1 to 12 from an old calendar and stick them on the face of the tin lid to make the dial of the clock.

Assemble the needles to complete the clock.

Instead of the tin lid you can also use a circular cardboard for the dial.

In this case you can sew one half of the press-button in the center of the cardboard.

SAND HOUR GLASS

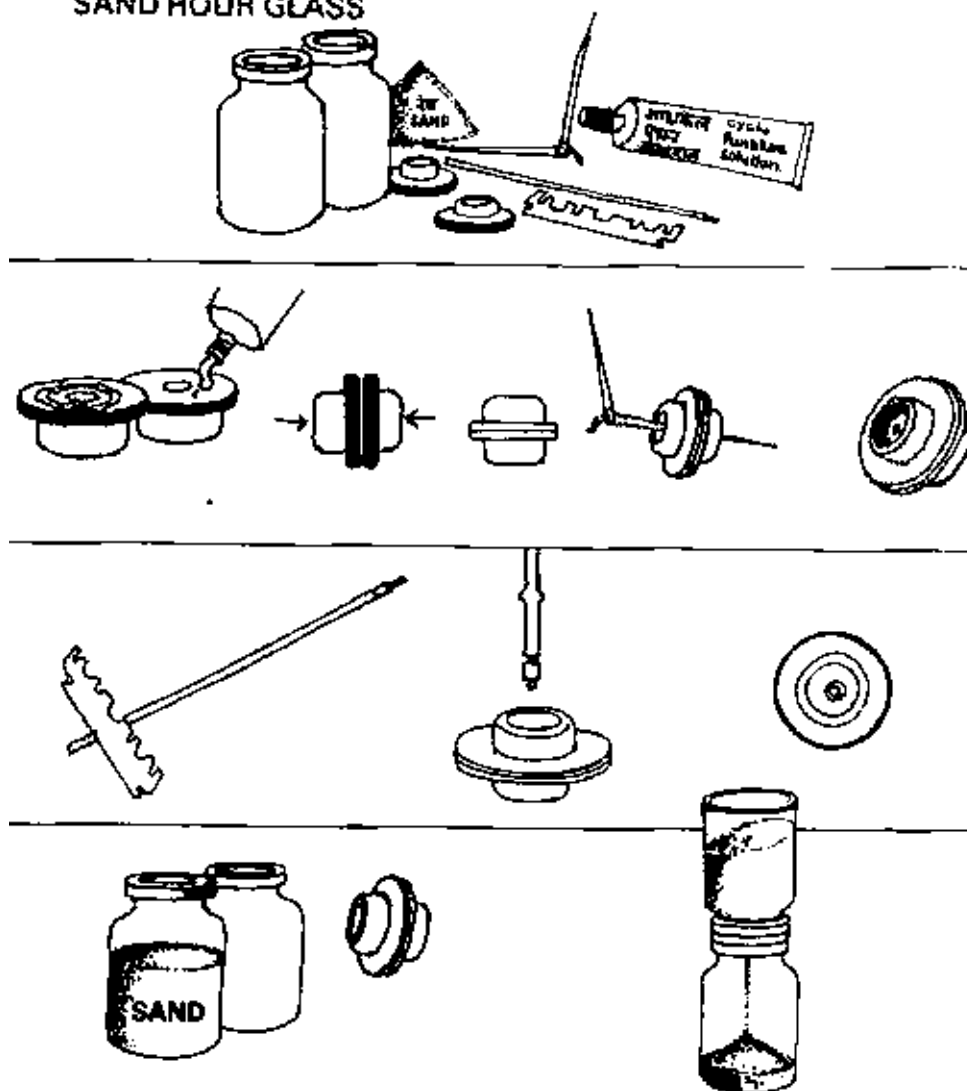

SAND HOUR GLASS

Take two clean injection bottles and their rubber caps.
Apply cycle puncture solution on the flat sides of the two rubber caps
and stick them back to back.

Make a see-through hole through the center of the caps by poking them with a thorn or a nail.
Insert a 5 mm. long piece of used ball pen refill in the hole between the two rubber caps.
The ball pen refill bore provides a smooth and uniform orifice for the flow of the sand.

Fill fine and dry sand in one of the injection bottles.

Assemble the two rubber caps and the other empty bottle on top of it.

On inverting this assembly, sand from the top bottle
will trickle down into the lower bottle through the ball pen tube 'neck'.

By filling in an appropriate quantity of sand and calibrating it against a standard
watch you can make a one-minute sand hourglass.

The sand hourglass will serve you as a reference for time. You can use it for finding:

How many times do you breathe in one minute?

How many times does your pulse beat in one minute?

How many steps do you walk in one minute?

How many oscillations does a pendulum make in a minute?

You can also use this sand hourglass to time your friend while playing chess,
scrabble or other games.



पुरानी नबबर चोपपल
OLD RUBBER CHAPPAL

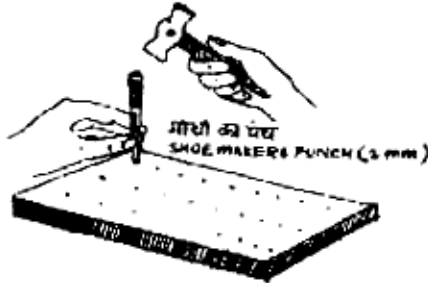

शोमी की पंच
SHOEMAKER'S PUNCH (2 mm)

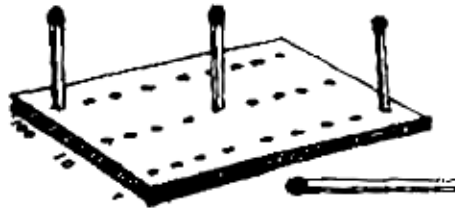

159

RUBBER ABACUS

RUBBER ABACUS

Cut a 5-cms x 10-cms piece from an old rubber slipper.

Mark out three columns and nine rows of dots on it.

Punch out holes on these dots using a 2-mm shoemaker's punch.

You can use this counter for counting your score in any game.

Inserting matchsticks in the holes indicates the score.

Starting from the right hand side, each column indicates units, tens and hundreds respectively.

Thus placing a matchstick in the topmost hole of the unit column can indicate nine.

Ten is indicated by placing a matchstick in the bottommost hole of the tens column.

Nine hundred is indicated by putting one matchstick in the topmost hole of the hundreds column.

A maximum of 999 can be indicated on this counter.

No matchsticks in the counter indicate zero.

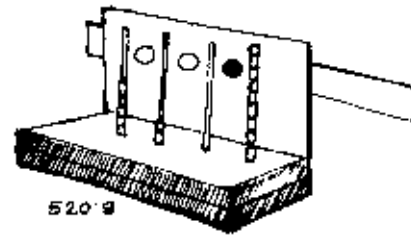
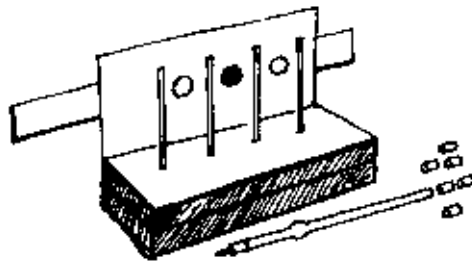
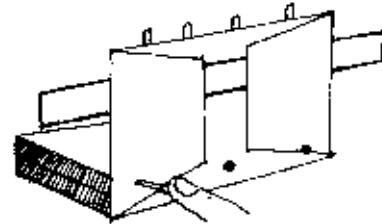
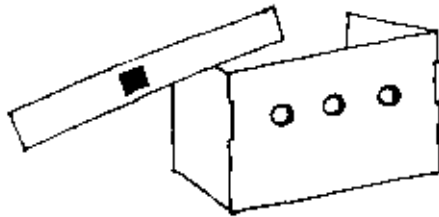
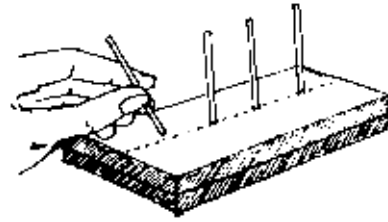

DECIMAL
ABACUS

DECIMAL ABACUS

Cut a 6-cms x 3-cms piece from an old rubber slipper.

Put marks at one-centimeter distances on its midline.

Insert four needles at right angles on these marks.

These needles should be 4.5-cms above the rubber surface.

Cut a 6-cms x 6-cms piece of old postcard.

Attach the postcard piece to the rubber with paper pins.

Make three holes and two vertical slits on the postcard piece.

Mark out a black spot on another postcard strip.

Weave this strip through the slits.

On sliding the strip, the decimal point will come in front of one of the holes in the postcard piece.

Take an old ball pen refill and cut it into half-centimeter pieces.

Each needle will be able to accommodate only 9 refill pieces.

The abacus in the picture indicates 520.9.

This abacus works on the same principle as the previous one.

COLOUR MIXER

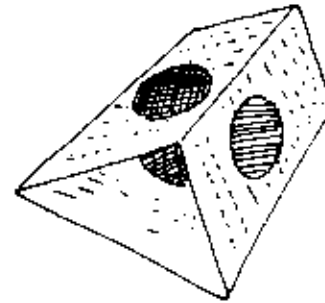
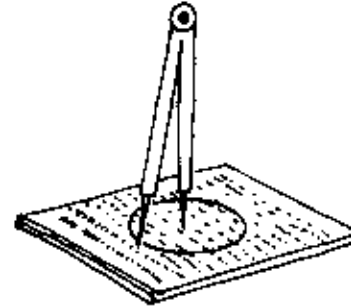
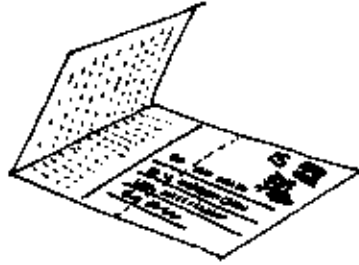

COLOUR MIXER

During Diwali time you must have seen coloured gelatin paper stuck on lanterns.

Collect several colours of gelatin paper.

Fold a postcard into three pieces.

With a divider cut three overlapping windows in the postcard.

Stick three different colours of gelatin paper on the windows.

View through these windows one at a time.

Then fold the red window on the blue one.

Do you see purple now?

Fold the yellow window on the blue one.

Do you see green now?

Similarly, make a colour mixer with four and six colours.

COLOUR WHEEL

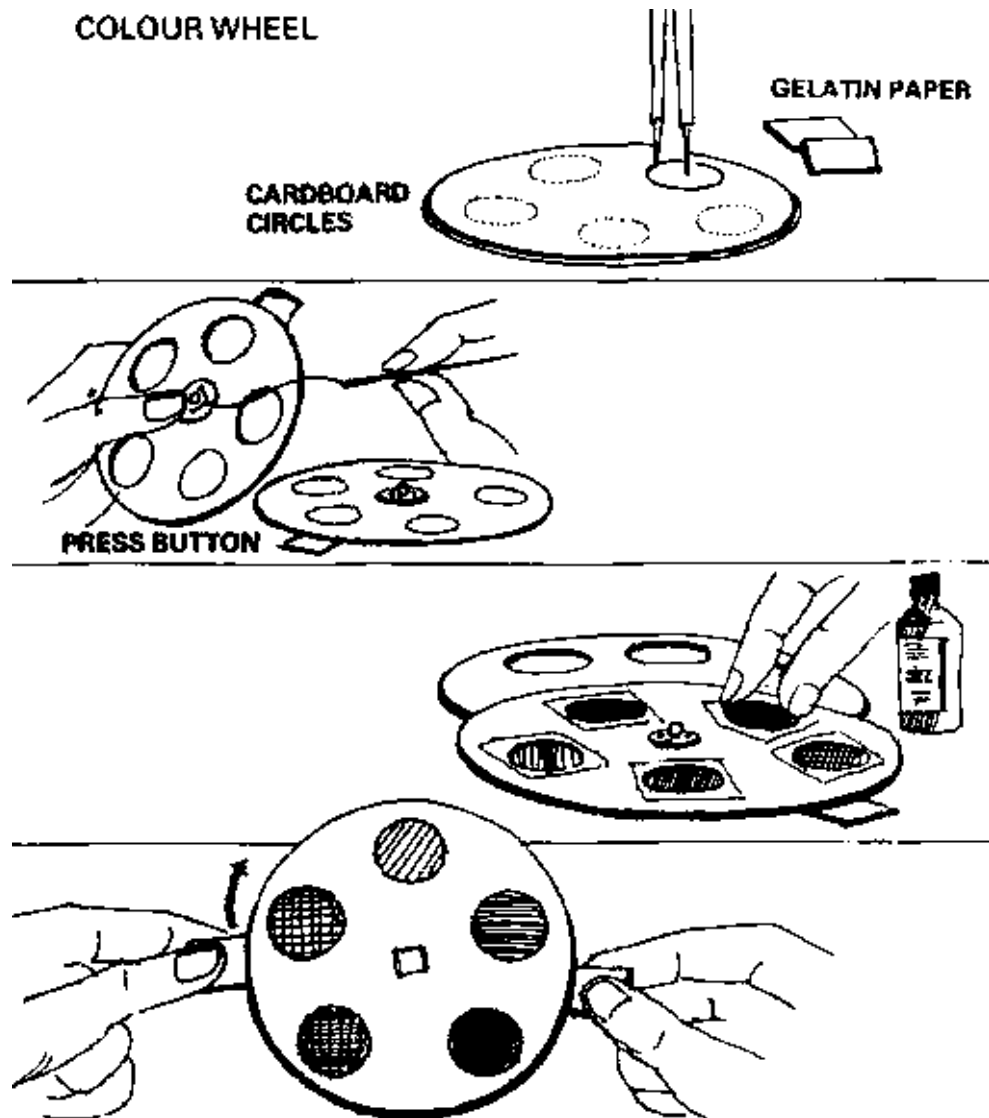

COLOUR WHEEL

Cut two 10-cms-diameter circles.

In each circle cut out five circular windows with the help of a divider.

Open a big press-button.

Stitch one half of each of this press-button at the center of each circle.

Stick different colours of gelatin papers on the windows.

Now, assemble both the colour cardboard circles together by snapping close both halves of the press-button.

The press-button not only holds the cardboard together, but it also enables them to rotate.

Rotate one cardboard circle, while keeping the other stationary, or rotating it in the opposite direction to see a motley combination of colours.

SODA WATER CAP GEARS

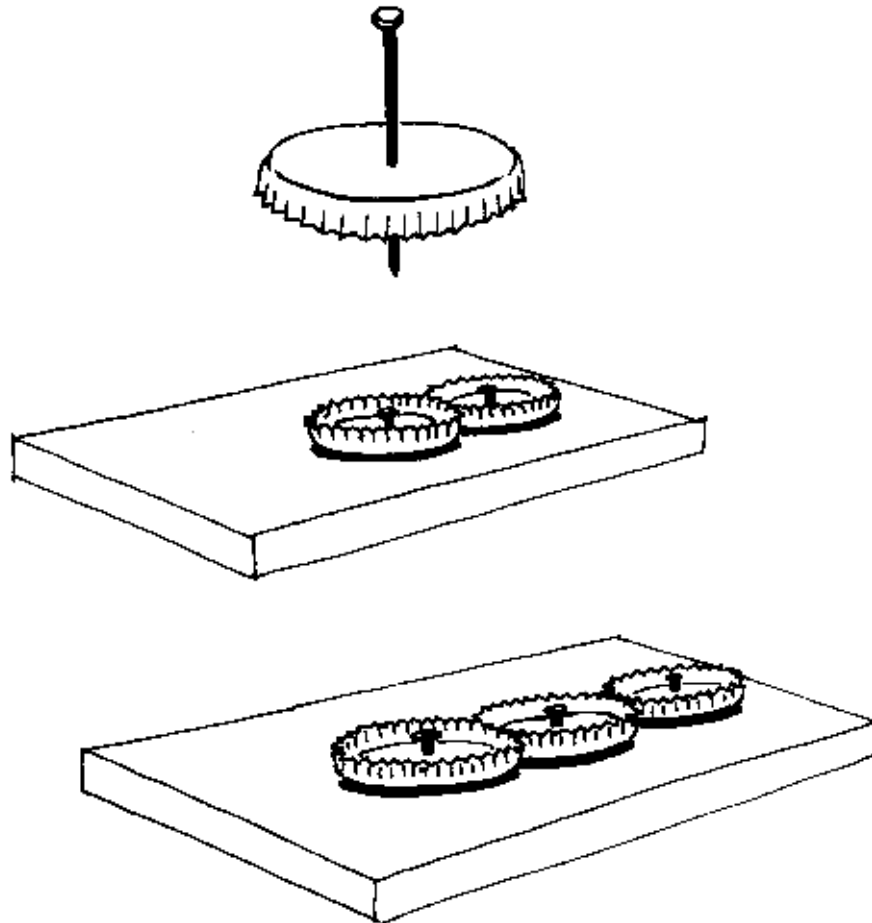

SODA WATER CAP GEARS

Collect a few soda water bottle caps.

Hammer a nail in their center to make a small hole.

Place two caps on a wooden plank, and mesh their teeth.

Drive a nail through the central hole in each cap, so that the caps can rotate freely.

Rotate one cap and see the direction of rotation of the other cap.

Now fix a third cap in mesh with either of the previous caps.

Observe the direction of rotation of the three caps.

RUBBER GEARS

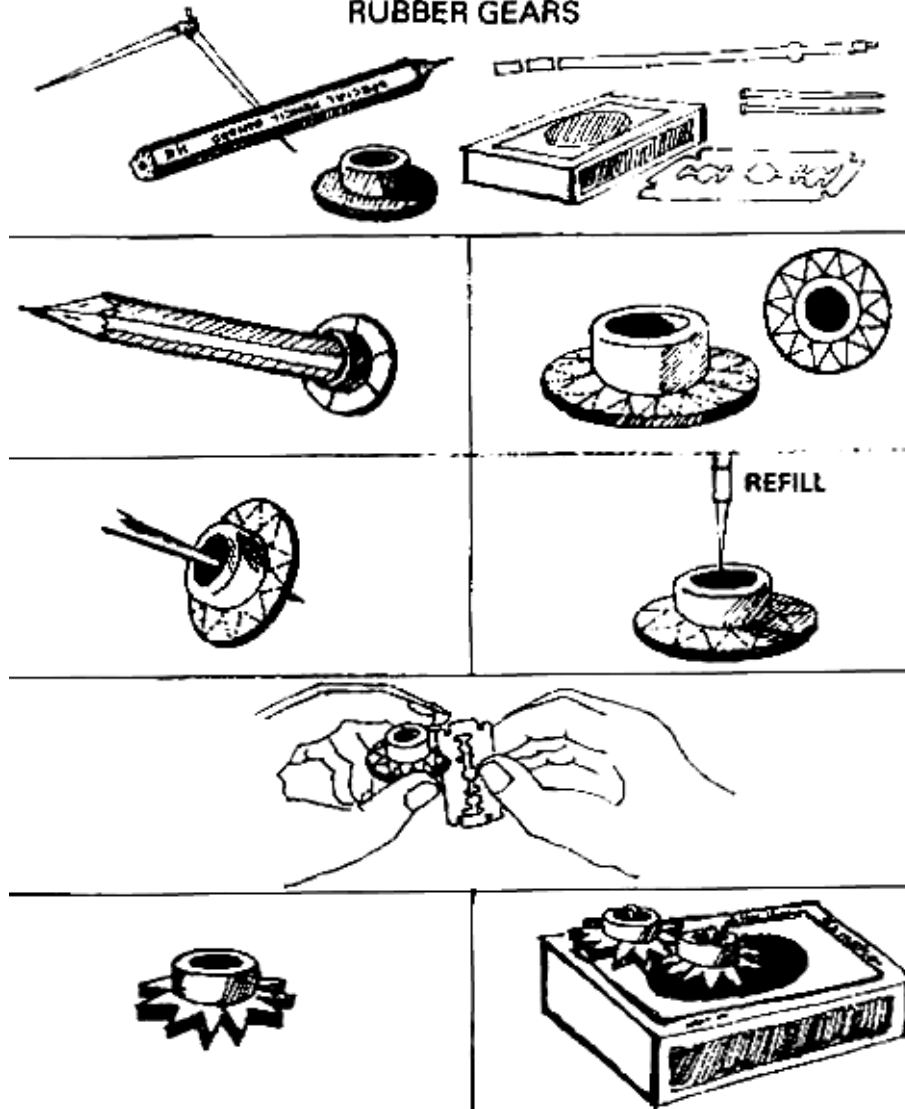

RUBBER GEARS

You can use injection bottle rubber caps to make unbreakable and flexible gears.

Using a hexagonal pencil as a template mark out six equally spaced points on the rim of the rubber cap.

Put mid points to divide the rubber rim into twelve equal sectors.

Join these points with a ball pen to make gear teeth.

Make a hole through the center of the rubber cap and insert a small piece of ball pen refill in it.

Using a sharp blade cut the teeth in the rubber gear.

Fix three or four of these gears in mesh with each other on top of a matchbox with paper pins.

On rotating one gear the entire gear train will rotate.

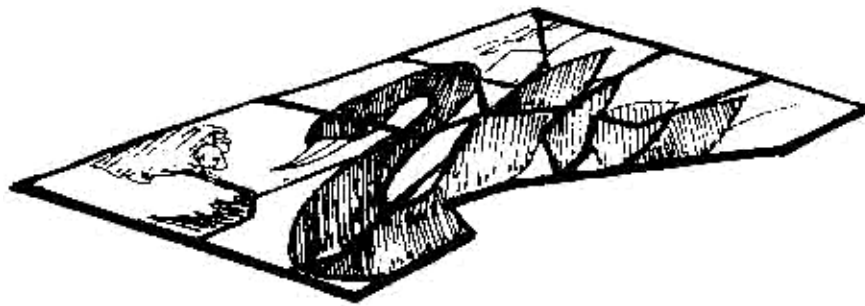
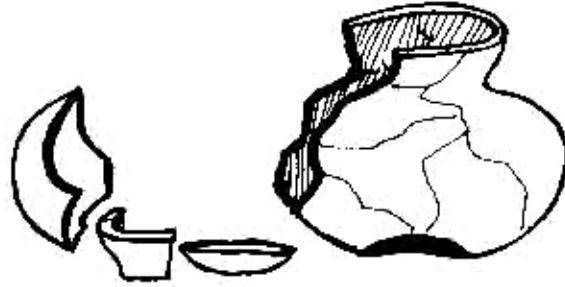

JIGSAW PUZZLES

JIGSAW PUZZLES

It is quite simple to make jigsaw puzzles at home.

This three- dimensional jigsaw consists of broken pieces of any clay pot or pitcher.

Give all the broken pieces of a clay pot to your friend
and ask her/him to piece it together with some clay paste.

Your friends will have to think pretty hard before they can figure out
how to put the pot pieces together.

Sticking any picture from a magazine or a newspaper on cardboard,
and cutting it into several pieces can make a two-dimensional jigsaw.

Ask your friend to assemble the pieces again into the picture.

You can start with making simple jigsaws.

Using just a few pieces in the beginning.

Later on you can make them very complicated by cutting them into very intricate shapes.

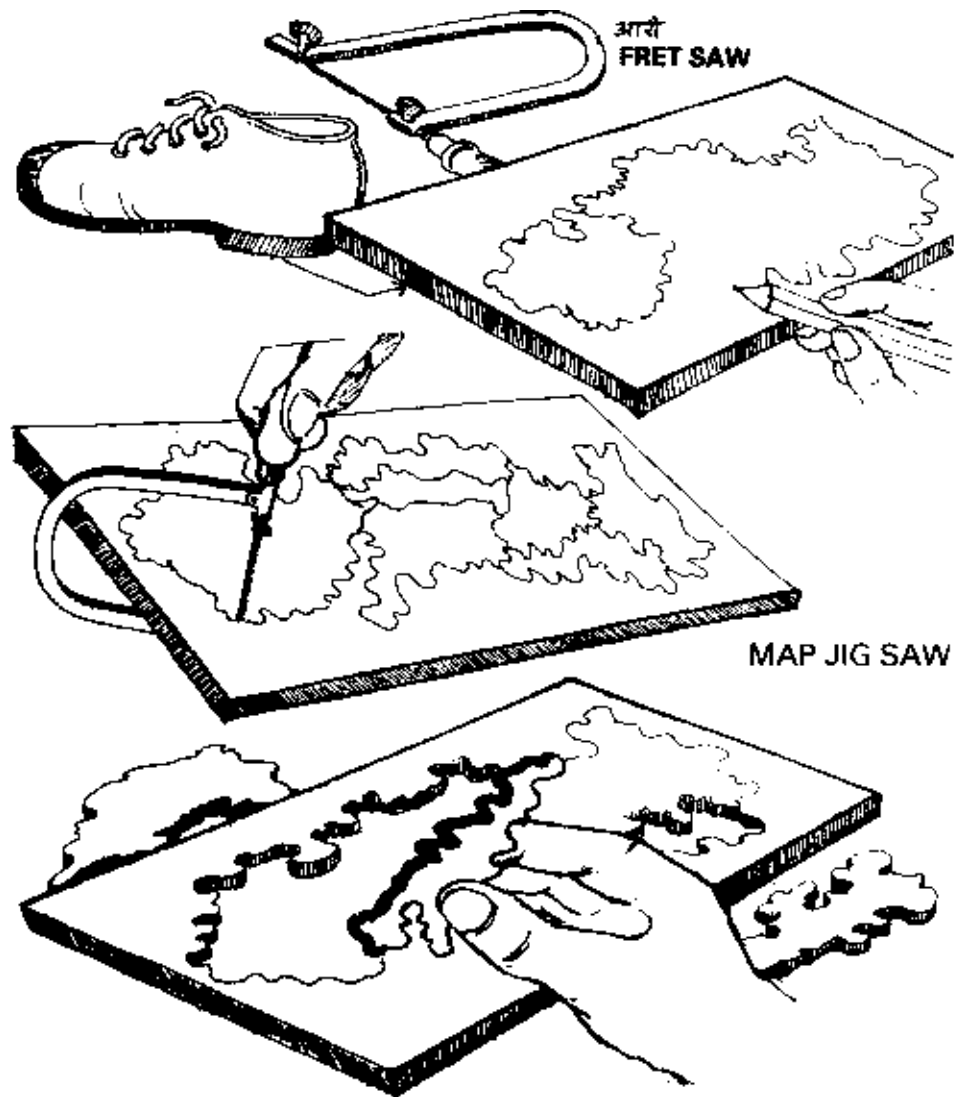

MAP JIGSAWS

Mark out the map of your District, with all the Blocks,
on a 4 -5 mm-thick sheet of shoe sole rubber.

Carefully cut out all the contours using a fret-saw.

Give all the pieces to your friends and ask them to assemble all the Blocks into the District.

In a similar way you can make a map jigsaw of your state or division.

The advantage of using shoe sole rubber is that
apart from being flexible and unbreakable it can be cut into fairly intricate contours.

As in wood, there are no sharp points in rubber, which can hurt you.

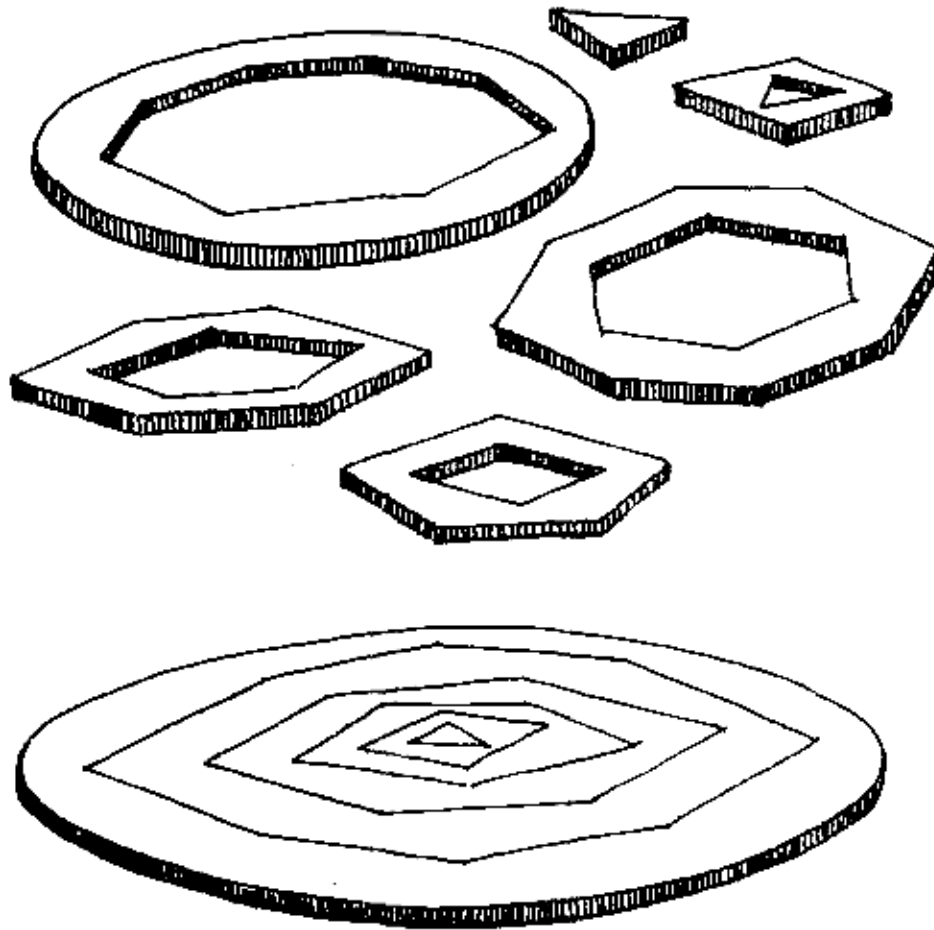

RUBBER POLYGONS

RUBBER POLYGONS

Cut out a 25-cms-diameter circle from a 6 mm. thick sheet of shoe sole rubber.

Mark out nesting polygons like a hexagon, octagon, pentagon, square and a triangle inside the circle.

Cut out these polygons with a sharp knife.

All these cut out polygons can be used as stencils.

They can also be assembled and disassembled any number of times.

Now try to flick the triangle like a wheel.

The triangle does not go very far. Try flicking other polygons.

You will find that the circle goes the furthest.

Why?

Several inset toys and puzzles – fixing the right cut outs and blocks in the appropriate slots can be made using shoe sole rubber.

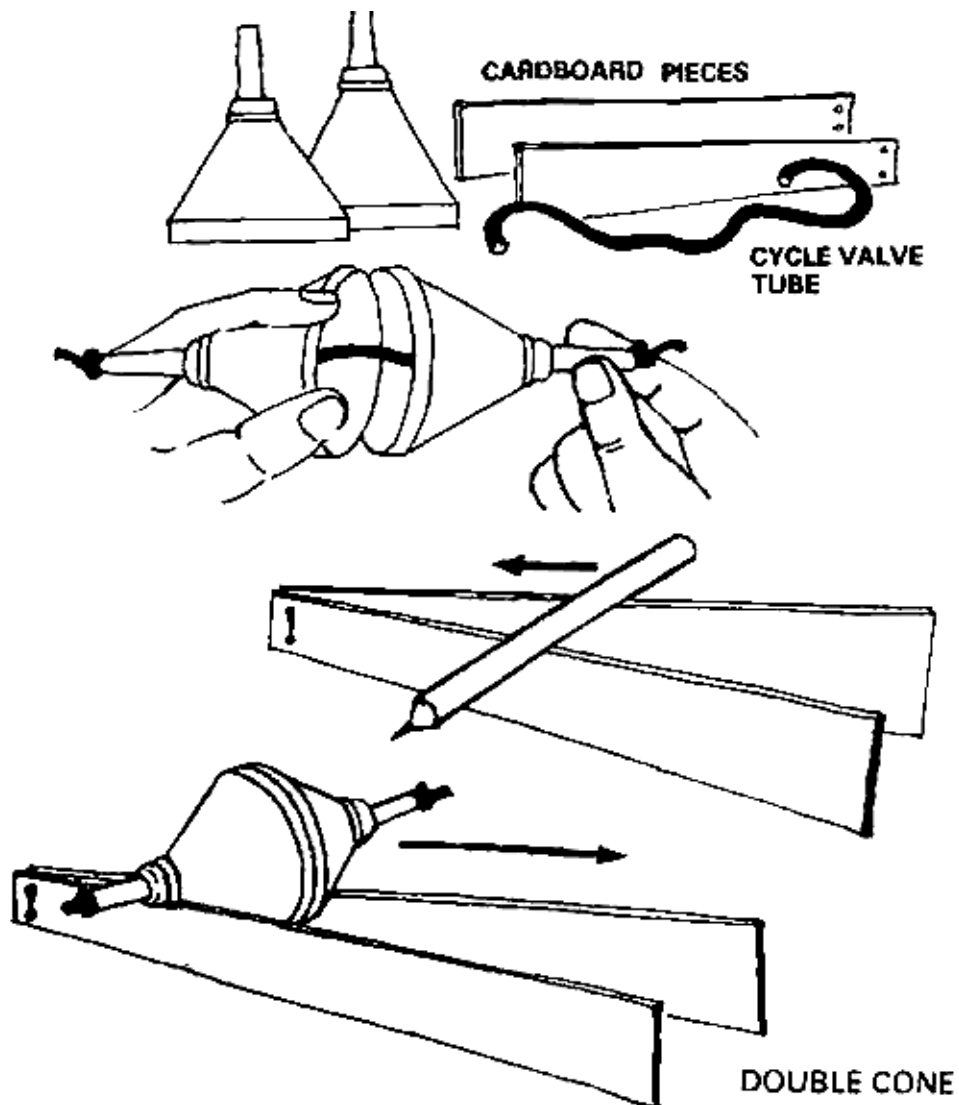

DOUBLE CONE

Most things slide down a ramp, but this double cone seems to defy gravity and climbs uphill.

How?

Mate the large circular ends of two plastic funnels and weave a cycle valve tube through them.

Stretch the valve tube and tie knots at both its ends.

The two funnels make a profile of a double cone.

Make a ramp out of two similar pieces old cardboard.

Place a cylindrical pencil on the higher end of this incline.

What happens?

As is to be expected the pencil rolls down the incline.

Now place the double cone on the lower end of the incline.

The double cone tends to climb upwards. Why?

The reason being that when the double cone is kept on the lower end of the ramp, its center of gravity is higher than the road level.

So there is some stored potential energy in the double cone which gets converted into kinetic energy.

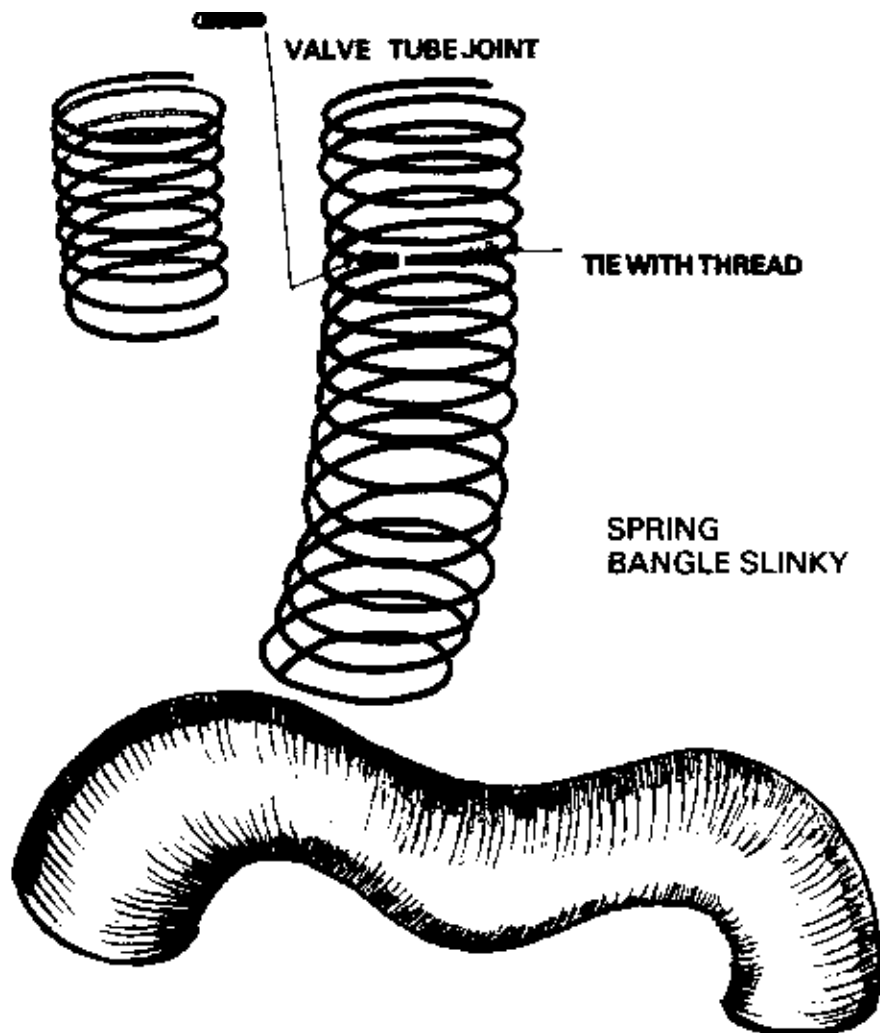

SPRING BANGLE SLINKY

Plastic spring bangles can be easily bought in village fairs.

Apart from the attractive colours each bangle has 24 coils in it.

Join three such bangles with pieces of cycle valve tube.

Tie the bangles with a thread on the opposite side of the valve tube.

Stretch both ends of the long slinky with your hands and jerk them inwards.

Waves will move inwards from both the ends and collide in the middle, giving you a feel of destructive interference of waves.

Hold one end of the long slinky stationary and jerk the other end inwards.

A wave will emanate from the jerked end. It will travel to the stationary end and return back.

This illustrates the phenomenon of an incident ray striking the normal and returning back as a reflected ray.

The bangle slinky gives a good feel for wave motion.

Now hold one end of this slinky and give this end a jerk on a smooth floor.

The slinky will slither like a caterpillar or a snake on the floor.

The intriguing motions of the slinky will entertain you for hours.

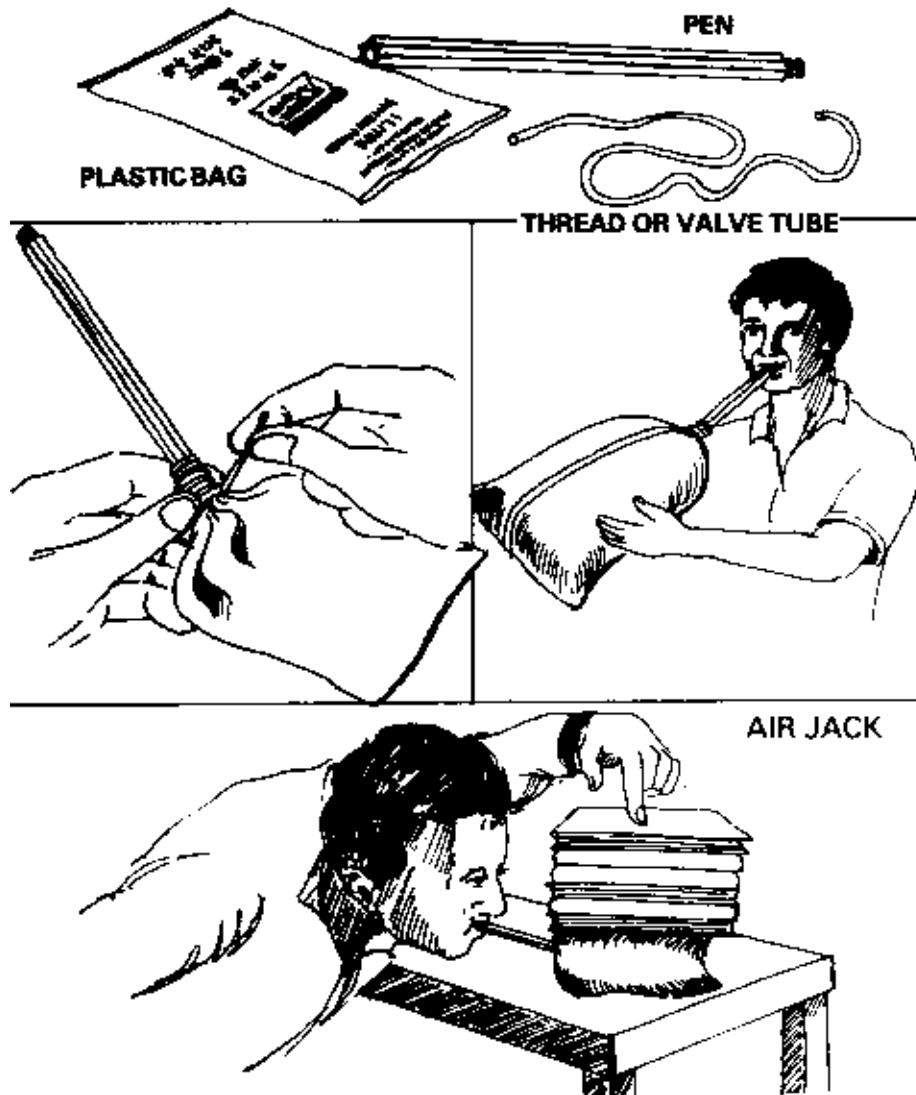

AIR JACK

While replacing a punctured tyre of a car a screw jack is used to raise the vehicle.

Modern jacks have dispensed the metallic screw.

These days, a thick rubber bag with a hose is used for lifting lightweight cars. The rubber bag is placed below the car chassis and the hose is inserted in the car exhaust.

Soon smoke from the running engine fills the bag.

As the rubber bag gets inflated it raises the car.

How to make your own Air Jack?

Take an empty plastic one-liter milk bag.

Tie an old pen body or a pipe on the mouth of the bag with a string or some cycle valve tube.

Place five or six fat books on the plastic bag and slowly fill air into it with your mouth.

As the bag gets inflated the books get raised.

How does this air jack work?

The pressure that you can exert with your mouth is limited.

But the large area of the milk bag magnifies this pressure, so that the resultant force - which is the product of the pressure and the area, is sufficient to provide uplift for the books.

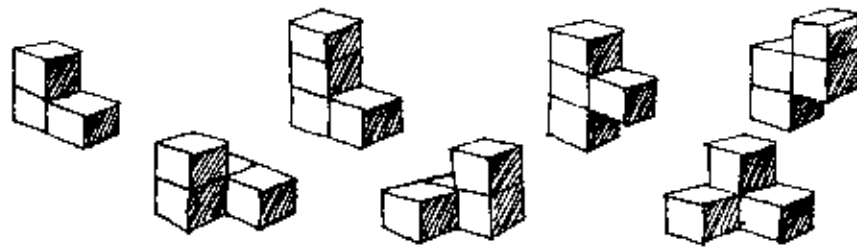
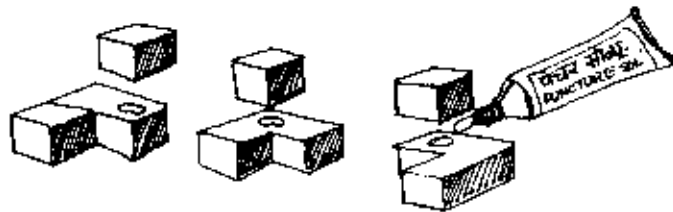
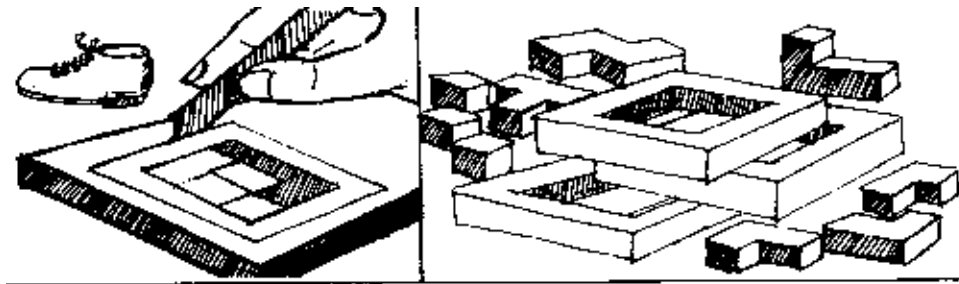

SOMA'S CUBE

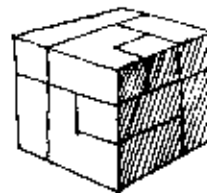
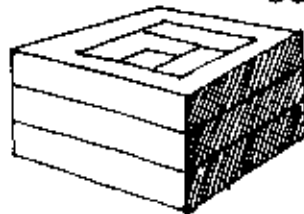

SOMA'S CUBE

Take 27 wooden or plastic cubes and stick them into seven shapes as shown in the illustration.

Now, assemble these seven shapes to form a big cube (3x3x3).

There are about 220 ways of making this cube.

Try and discover as many ways as you can.

The illustration also shows the procedure to make a Soma's cube and its box out of shoe sole rubber.

The box will house the big cube.

SOMA CUBE PATTERNS

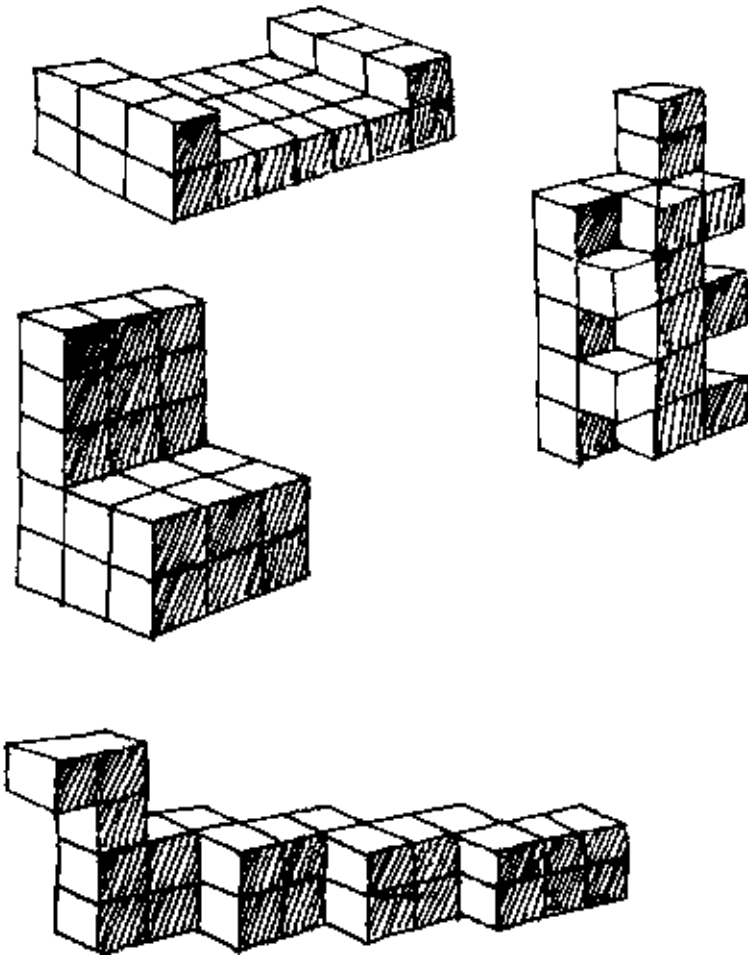

SOMA CUBE PATTERNS

The seven pieces of the Soma cube puzzle can also be arranged to make a cot, a chair, a snake etc. You can arrange them into new patterns to make your own designs.

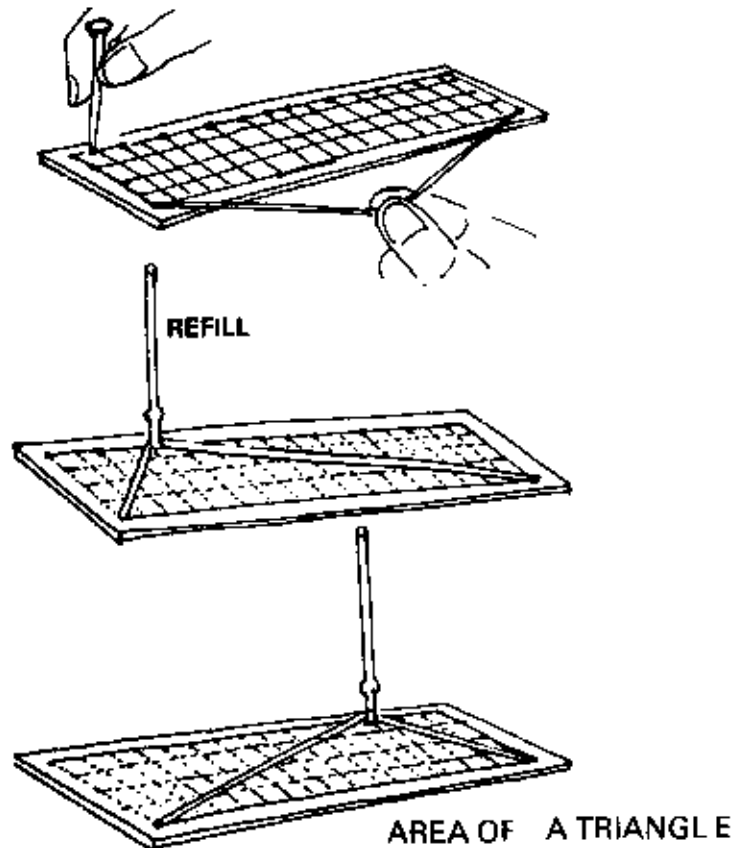
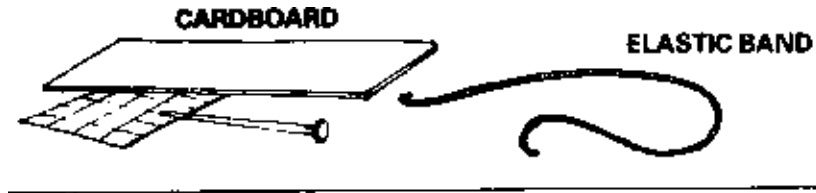

AREA OF A TRIANGLE

This little model tests that the area of a triangle depends on its height and base.

Stick a graph or any other square paper on a rectangular piece of cardboard.

Make two holes near the base of the rectangle.

Weave an elastic thread or a cut rubber band through these holes and tie knots to hold the elastic thread in place.

The elastic thread will be the base of the triangle.

Determine the area of the triangle by counting the number of squares contained in it.

By shifting the position of the refill make triangles of different shapes.

Each time count their area.

Because the triangles are on the same base and have the same height, their area will remain the same.

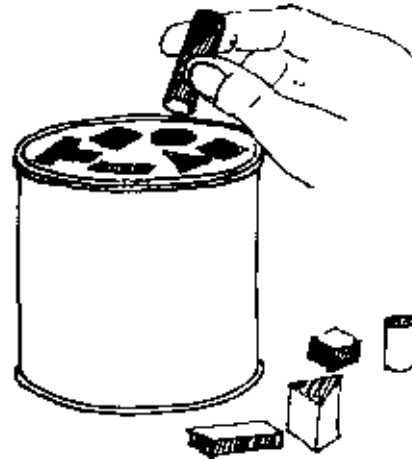
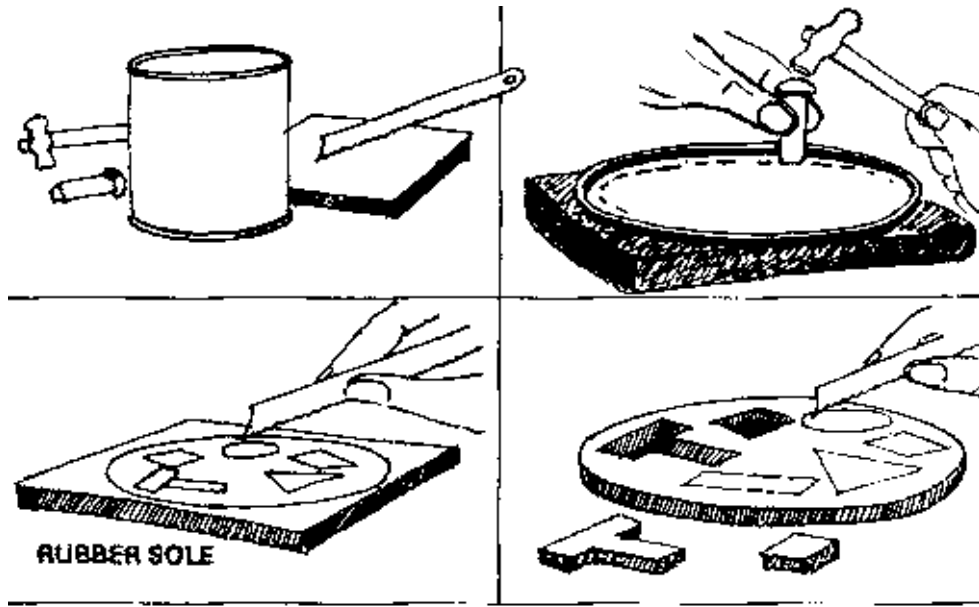

POST BOX

POST BOX

Take an old tin box.

Cut the inner portion of the lid with a chisel and a hammer,
leaving a little margin from the rim.

Cut a circle out of shoe sole rubber so as to fit snugly in the lid.

Cut different geometrical shapes in the rubber circle.

Now post the cut out shapes in the appropriate slots of the post box.

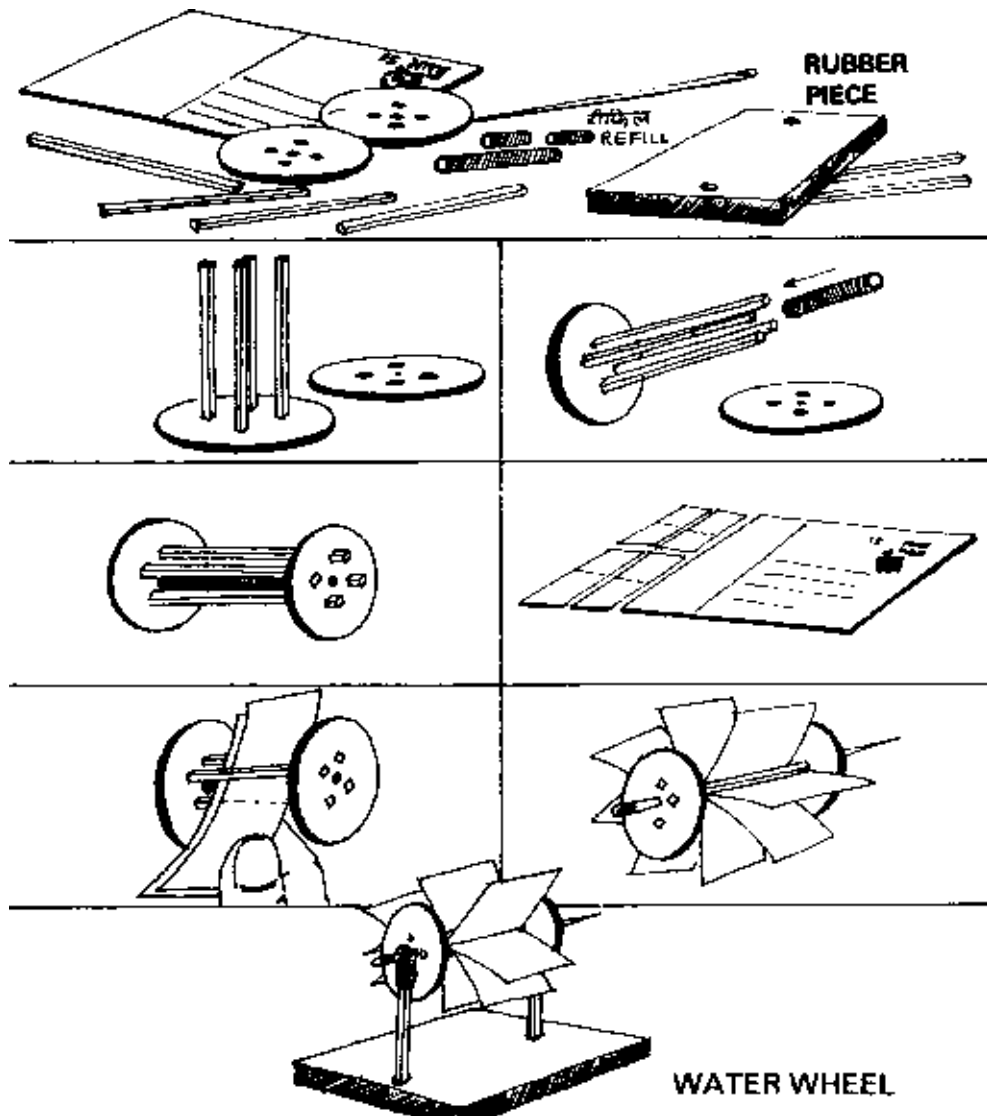

WATER WHEEL

What a water wheel!

Cut the sulfur heads of four matchsticks and insert them in the four holes of a cheap quality plastic coat button.

Slip a piece of refill between the matchsticks.

Fix another button on the open ends of the matchsticks.

Cut out four strips from an old postcard.

Bend these strips and insert them between the matchsticks.

With a hot needlepoint make holes in the centers of the buttons.

The needle axle will pass through these holes.

Make two holes on a piece of old rubber slipper.

Affix two vertical matchsticks in these holes.

Fix the water wheel axle to the matchsticks with bits of valve tube.

Blow on the water wheel to make it whirl.

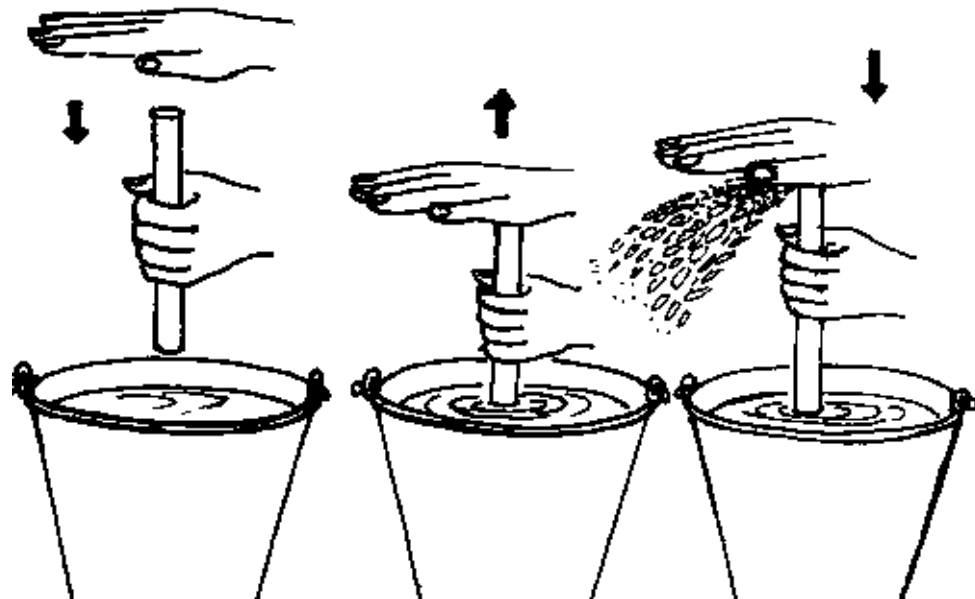
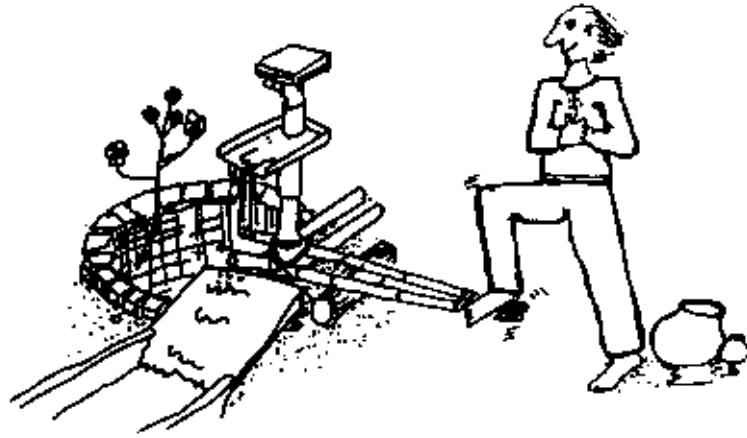

INERTIA PUMP

Suresh Vaidyarajan designed this simple pump.

Any hollow tube PVC, metal bamboo,
or a one-foot long Papaya stem can be made to pump up water.
Hold the tube with your left hand and move it up and down into a bucket of water.

Keep the palm of your right hand on the top of the tube
and open and close it with each up and down reciprocation.

Soon water will start squirting out.

In this case the up-down motion of the left hand does the pumping
while the right palm acts like a valve.

The use of the hand palm gives a very good physical feel for a valve.

Try and find the maximum height to which you can lift water by this means.

Such pumps are still used in some parts of Andhra Pradesh.

