

# AHA! ACTIVITIES

ARVIND GUPTA

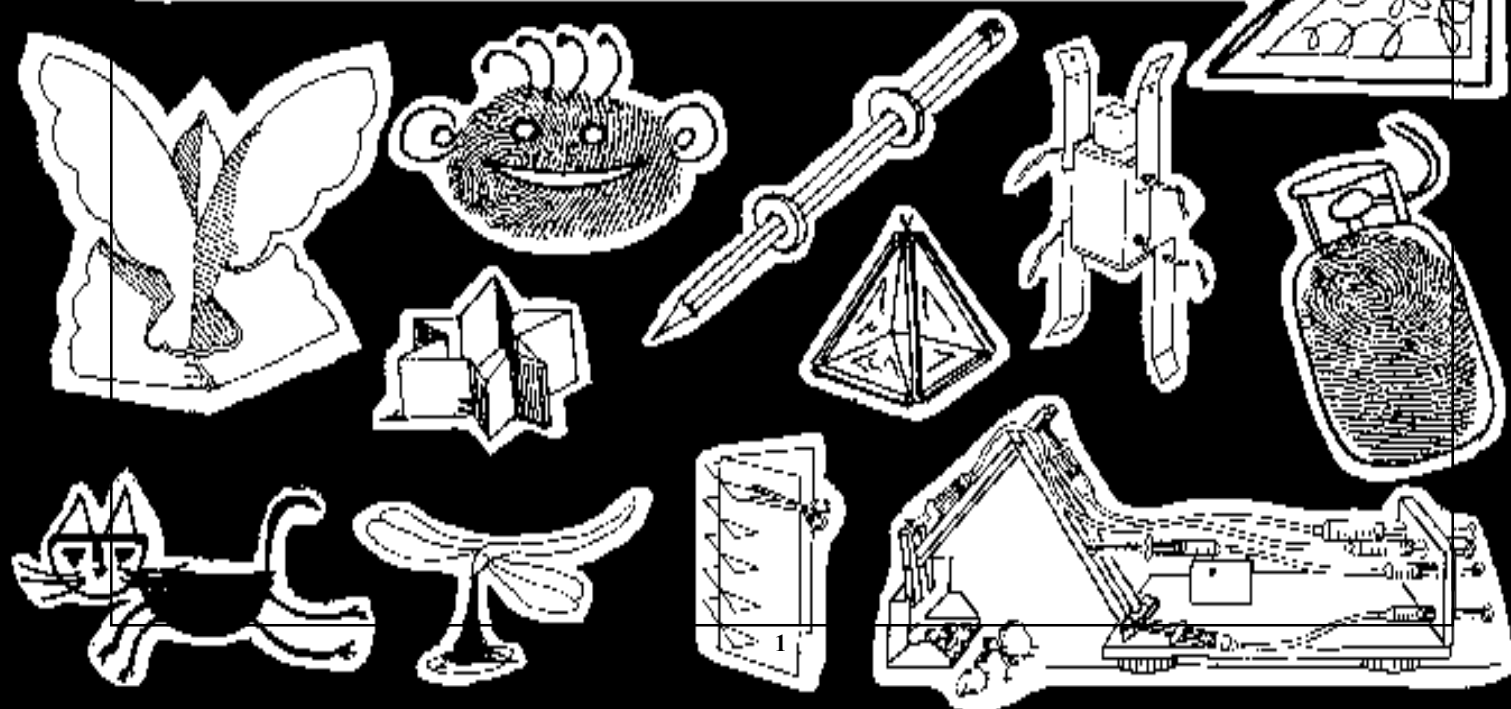

# AHA! ACTIVITIES

**ARVIND GUPTA**

Illustration & Layout  
**MONIL DALAL**

# CONTENTS

<i>Page</i>	<i>Title / Activity</i>	<i>Page</i>	<i>Title / Activity</i>
1.	Sustainable Science	51.	Matchstick Illusion / Square Into a Triangle
2.	What did you learn in school today?	52.	Grid of Equilateral Triangles
3.	Lifting an Aeroplane	53.	Grid of Equilateral Triangles (continued)
4.	Paper Aeroplane	54.	Symmetry / Which Holds More?
5.	Paper Aeroplane (continued)	55.	20 Triangles Make a Perfect Square / Simplest Motor
6.	Bird of Peace	56.	Jumping Rubber Band / Escaping Rubber Band
7.	Folding Calendar	57.	Sensitive Fan / Shooting Rubber Band
8.	Springy Cat	58.	Living on Books
9.	Parts of a Circle	59.	What do we plant? / Strange Clay Ball
10.	My Country School Diary	60.	Periodic Table of the Elements
11.	The Animal School : a parable	61.	Periodic Table of the Elements (continued)
12.	Rectangular Paper Box	62.	Crazy Magnet / Fishy / Minute Measurements
13.	Paper Clapper	63.	Standing a Stick / A Handy Drawing Glass
14.	Paper Structures	64.	Thumbprints
15.	Paper Structures (continued)	65.	Thumbprints (continued)
16.	It Levitates, It Spins, It Writes	66.	Letter Y Tree
17.	Rotating Loop of Thread	67.	Balancing a Scale / Closing Tips! / Which will roll faster?
18.	Animal Pictures	68.	Balloon Pump
19.	Animal Pictures (continued)	69.	Syringe Pump / Linking them together
20.	Albert Einstein's Legacy	70.	If Sharks were People
21.	Albert Einstein's Legacy (continued)	71.	Obstacle-race game / Jigsaw
22.	Humming Hanger	72.	Corner Bookmark / String Picture
23.	Spinning Bottle	73.	Dodecahedron
24.	Which Holds More?	74.	Square Flexagons / Folding Cubes
25.	Simple Rain Gauge	75.	Maths Teasers
26.	Prank with a Plank / Matchstick Picking	76.	Balancing Dragonfly
27.	Small is Strong / Following Instructions	77.	Dancing Fall / How much is a Newton? / Forceful Fall
28.	Two-in-One	78.	Swinging Acrobat
29.	A Colourful Surprise	79.	Swinging Acrobat (continued)
30.	Polish Pedagogue	80.	Mathematical Proof vs. Scientific Proof
31.	Can you pick the handkerchief? / Matchless Matchstick	81.	Boxers
32.	Soap Bubbles	82.	Buzz Saw / Card sheet Bird
33.	Soap Bubbles (continued)	83.	Coconut Craft - Swallow / Windmill
34.	Large Soap Films	84.	Jumping Jack
35.	Climbing Man	85.	Dancing Elephant / Mathematical Rigour
36.	Braille Cube	86.	ABC pictures
37.	Rubber Stamps	87.	ABC pictures (continued)
38.	Flat Flexagon	88.	ABC pictures (continued)
39.	Flat Flexagon (continued) / Streamlining	89.	Hydraulic Truck
40.	Light the Lamp Within, Teacher	90.	Doing their Duty
41.	Floating Ball	91.	Hand Shadows
42.	Paper Pop-Up	92.	Math Magic
43.	Multi Step, Pop-Up	93.	Value of Pi
44.	Balancing Nails	94.	Cross into Square / Perforated Symmetry
45.	Osmosis Bottle	95.	Shifting Water / Hot, Hotter, Hottest! / Tetrahedron
46.	A tricky Circle / Sinking and Floating	96.	Spooky Fan / Buzzing Insect
47.	Rocket Projectile	97.	Corrugated Creations
48.	Air Propelled Boat	98.	Beautiful Bridge / Digital Dexterity
49.	Balloon in bottle / Blow out! / Wasted breath / No windfall	99.	Flying Kite / Capillary Cloth
50.	The Man who loved Insects	100.	Birthdays

# CONTENTS

<i>Page</i>	<i>Title / Activity</i>	<i>Page</i>	<i>Title / Activity</i>
101.	Hanky Rabbit	111.	Boyle's Balloon / Many Signs, One Sun
102.	Drip Machine	112.	Continetal Jigsaw
103.	Drip Machine (continued)	113.	Finger Stretching / Runaway Thumb
104.	Bird Plane / Paper Beads	114.	Seven Secret's of Success / Wheel of Measure
105.	Glider	115.	Only Teaching
106.	Ice-cream Stick Bomb / Magnetic Hand	116.	Acrobat
107.	Rabbit Race / Swinging Nuts	117.	Acrobat (continued) / Whip-crack
108.	Paper Cup Race / Card Cupboards	118.	Mirror Images
109.	Stand-Up Animals	119.	Referances
110.	The lady who loved her library	120.	Suggested Books on Education, Science & Maths

Believe nothing,  
merely because you have been told to.  
Or because it is traditional.  
Or because you yourself have imagined it.  
Do not believe what your teacher tells you...  
merely out of respect for the teacher.  
But whatever after due examination and  
analysis you find, conducive to the good and  
benefit, the welfare of all beings, that doctrine  
believe and cling to and take it as your goal.



## SUSTAINABLE SCIENCE

Science starts making sense when children make simple models.



Children with poor scores are often better with their hands than “star” students.

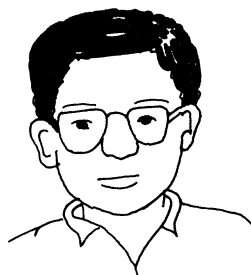

All children like to rip open toys and see what is inside. The best thing a child can do with a toy is to break it!



The whole world is a garbage pit, Collect some junk and make a kit!



I can barely complete the curriculum. Where is the time to do experiments?



Where is the money to buy science kits? With sixty children doing experiments I will go bonkers!



Serious teachers have always raised such questions. These are legitimate concerns. With paucity of funds and poor infrastructure - how does one do justice to activity based science? There is enough evidence the world over to show that readymade kits gather dust. The models the children and teachers make themselves remain more enduring. There are amazing possibilities of doing creative science using simple, readily available materials.

The Second World War saw several countries devastated. Under severe economic hardships many poor countries reconstructed school buildings. But then they had little money left to set up science laboratories - which were expensive to set up. In the late 1950's J. P. Stephenson a British teacher wrote a book showing the possibilities of doing process based science using utterly simple materials. The title of the book was *Suggestions for Science Teachers in Devastated Countries*. This book took the world by storm. It showed that expensive, fancy equipment were far removed from the lives of ordinary children - in fact very alienating. Unesco agreed to widen and deepen the scope of the book and thus came out the famous *Unesco Source Book for Science Teaching* - the bible for science activities. In 1963, this book was translated in Hindi, Marathi, and some other regional languages. The vernacular editions have unfortunately been out of print for decades.

Inspired teachers don't get bogged down by rules and regulations. The weighty state curriculum does not cow them down. Instead, they carve out a special niche for themselves. They have faith in the resources and resilience of children. The limitation of the chalk-and-talk method are well known. They know that “activities” constitute great learning and children love them. They involve children as partners in organising activities. They inspire children to recycle, reuse, reinvent waste into joyous toys and simple science models.

This is my twelfth book on science activities. All my books have been digitised. They can be easily downloaded. I can't print photographs in my books because they will make them expensive. But there are 600 coloured photographs of TOYS FROM TRASH on my website. All these and several other interesting books on science activities, education and peace can be downloaded for free from my website: <http://arvindguptatoys.com>

## WHAT DID YOU LEARN IN SCHOOL TODAY?

An anonymous poem which show how schools become unquestioning accomplices in the furtherance of political agendas in the classrooms, from 'patriotism' to the 'power of the state.'

What did you learn in school today,  
Dear little boy of mine?  
What did you learn in school today,  
Dear little boy of mine?  
I learned that Nehru never told a lie,  
I learned that soldiers never die,

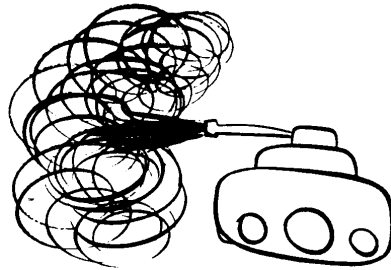

I learned that everybody's free,  
That's what the teacher said to me,  
And that's what I learned in school today,  
That's what I learned in school.

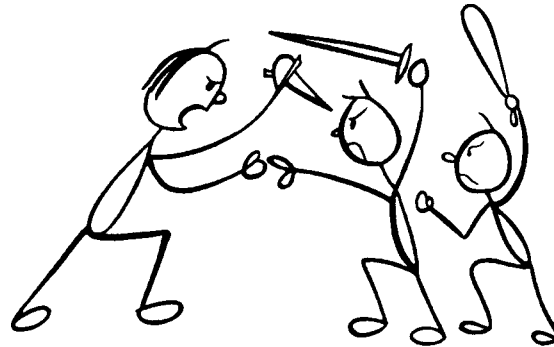

What did you learn in school today,  
Dear little boy of mine?  
I learned that policemen are my friends,  
I learned that justice never ends,  
I learned that murderers die for their crimes,  
Even if we make a mistake sometimes,  
And that's what I learned in school today.

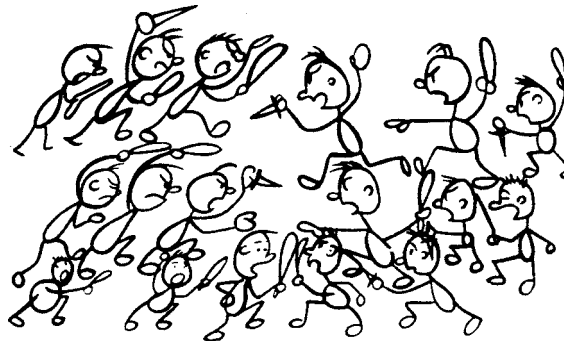

What did you learn in school today,  
Dear little boy of mine?  
I learned our governments must be strong,  
It's always right and never wrong,  
Our leaders are the finest men,  
And we elect them again and again,  
And that's what I learned in school today.

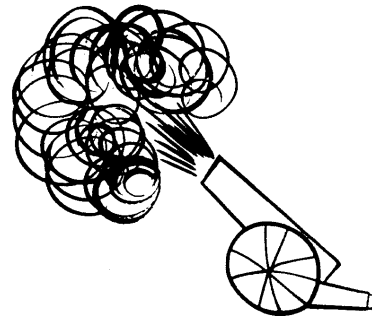

What did you learn in school today,  
Dear little boy of mine?  
I learned that war is not so bad,  
I learned about the great ones we have had,  
The ones with *Pak* and the ones with *Cheen*  
And how it must make me preen,  
That's what I learned in school today.

Pix: Munro Leaf

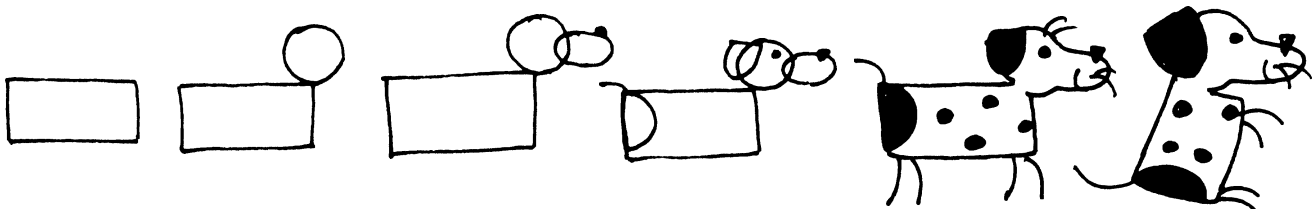

## LIFTING AN AEROPLANE

Using simple things one can show how 'lift' is produced by the wings of an aircraft.  
It is this lift which keeps a very heavy aircraft afloat in air.

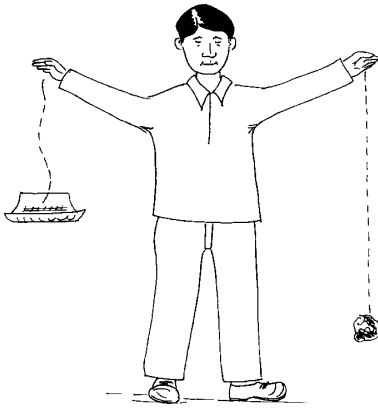

1. Take two same size papers from your old notebook. Crumple one into a ball. Hold the crumpled paper and the flat paper high above your head. Drop them both at the same time. Gravity will pull both the sheets down. Which will fall first? Why does the flat sheet fall slowly?

The flat sheet of paper falling downwards pushes against the air in its path. The air pushes back and slows its fall. The crumpled ball has a smaller surface pushing the air.

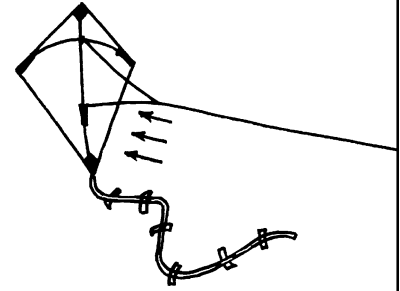

2. The spread out wings of an aeroplane or a kite prevent it from falling. We say that the wings give a plane lift.

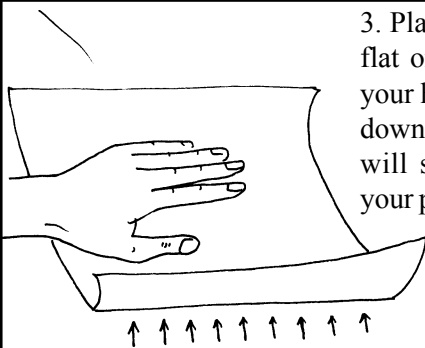

3. Place a sheet of paper flat on your palm. Turn your hand over and push down quickly. The paper will stay glued against your palm.



4. Now hold the crumpled ball of paper in your hand. Again upturn your hand and push down. The smaller surface of the paper hits less air. You will feel less of the push against your hand. Unless you push down very quickly the paper will fall to the ground before your hand reaches it.

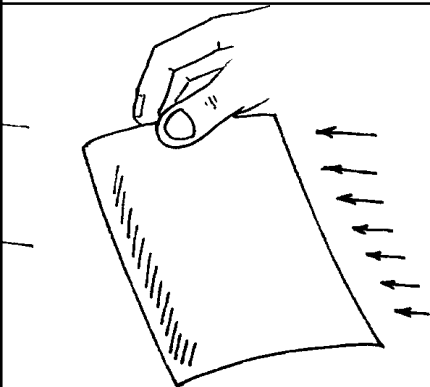

5. Hold one end of a sheet of paper and move it quickly through the air. The flat sheet hits the air against its path. The air pushes up the free end of the moving paper. The paper aeroplane must move through the air so that it can stay up longer in the air.

The wing of the aircraft is humped on the top. When the aircraft travels the air is divided into two streams. One stream flows goes straight below the wing. The other goes over the hump and travels a longer distance. As both streams meet at the trailing end, the upper stream has to travel faster. This high speed leads to low pressure and provides 'lift' from below. This can be demonstrated through the following experiments.

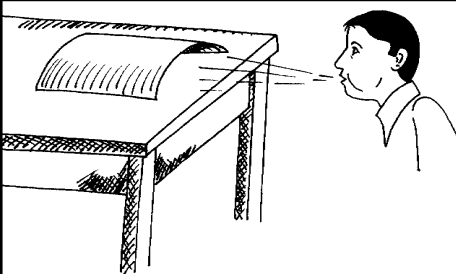

6. Bend a piece of stiff paper into a dome and rest it on a table. Blow under the curve of the paper. Instead of lifting up the paper will be pressed down. Why does that happen?

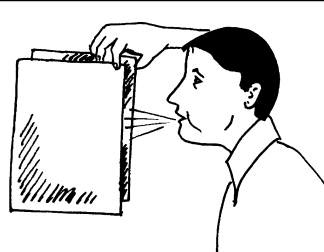

7. Hold two thin sheets of paper so that they hang downwards with a space between them. Blow between the papers. What will happen? Why?

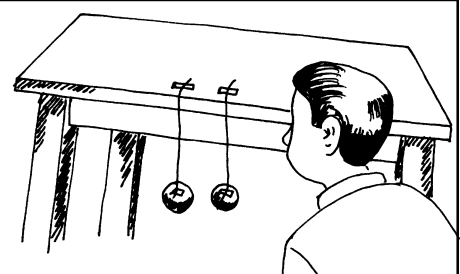

8. Try with two ping-pong balls. Tape them to two threads and hang them from the edge of a table. Blow between them. The balls come close and strike one-another. Why?

## PAPER AEROPLANE

Make a simple paper aeroplane to understand the various forces on it during flight.

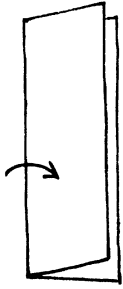

1. Take a sheet of Xerox paper 21.5-cm x 28-cm. Fold the paper in half along the length.

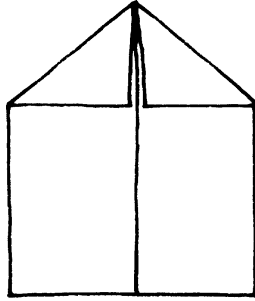

2. Open the paper and fold both corners down towards the centre.

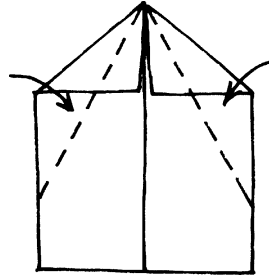

3. Fold one side again towards the centre along the dotted line.

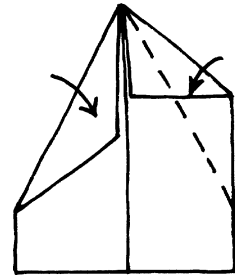

4. Fold the other side along the dotted line.

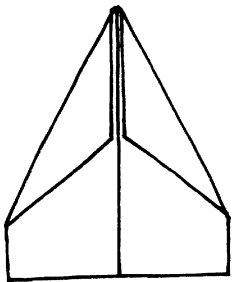

5. Make sure the folds are sharply creased.

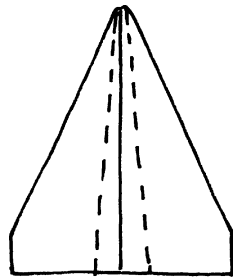

6. Turn the paper over.



7. Fold one side over along the left-hand dotted line

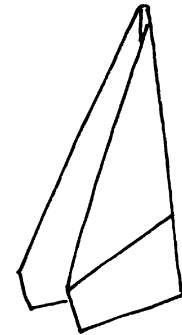

8. Fold the other side over along the right-hand dotted line.

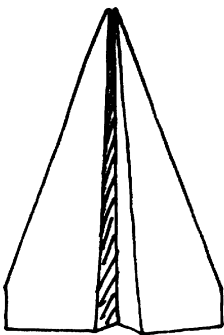

9. From the bottom the plane should look like this.

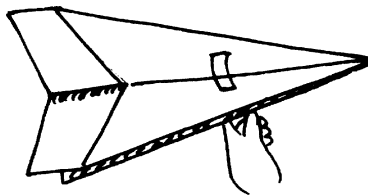

10. Use a piece of cello tape to hold the body of the plane together. Give its wings a slight upward tilt.

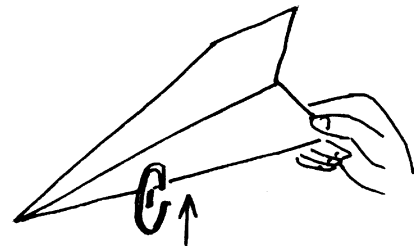

11. Launch your plane. Try increasing its thrust by throwing it harder. If the plane flutters and slips from side-to-side, try putting a paper clip.

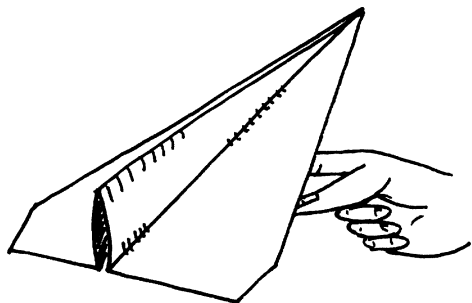

12. The position of the paper clip changes the point at which the plane's weight is balanced. This point is called the centre of gravity. To find the centre of gravity of your plane try to balance it on one finger. The plane's centre of gravity is where it balances on one finger.



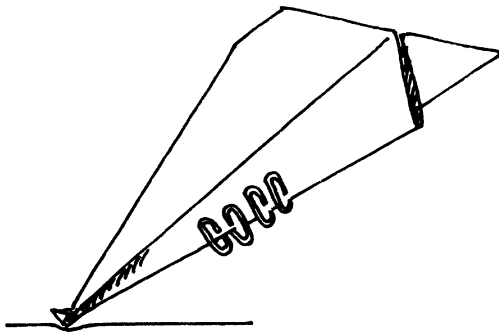

13. What happens to the position of the centre of gravity if you add a paper clip? Where should you place the paper clip for the longest flight? Adding a paper clip not only changes the plane's balance point but also adds to the plane's weight. Try putting two paper clips in the same position. Does the plane stay up in the air as long as with one clip? Try adding three paper clips. What happens now? What would happen if you put 8 paper clips? Real aeroplanes are made of lightweight metals. Planes must also have their cargo carefully balanced before take-off.

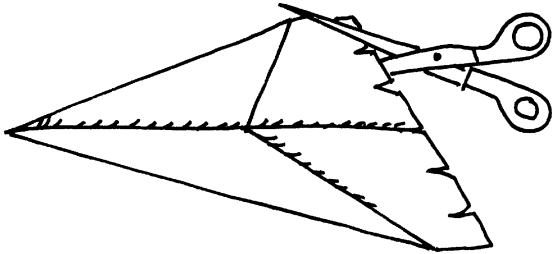

14. Throw your plane into the wind and then try throwing it with the wind. Compare the two flights. In which direction does the wind seem to give the plane more lift? Which way does the flight last longer? Real planes try to take off and land into the wind. Why?

Try making two 1.3-cm cuts 3.5-cm apart in the back edge of each wing. Fold the paper between the cuts at a slightly upward angle.

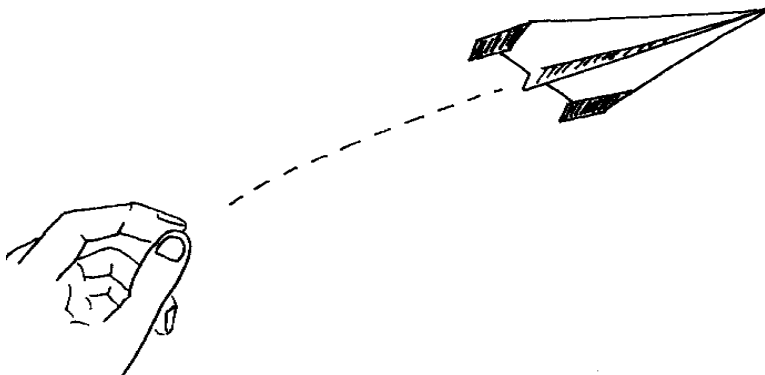

15. These flaps will help the plane go up or down. Launch the plane with the flaps at this upward angle. Do the flaps change the flight of the plane? Flatten the flaps and check. Does it make a difference? The flaps change the direction of the flight. As the plane moves through the air, the flaps push against the air. With an equal force, the air pushes back against the flaps.

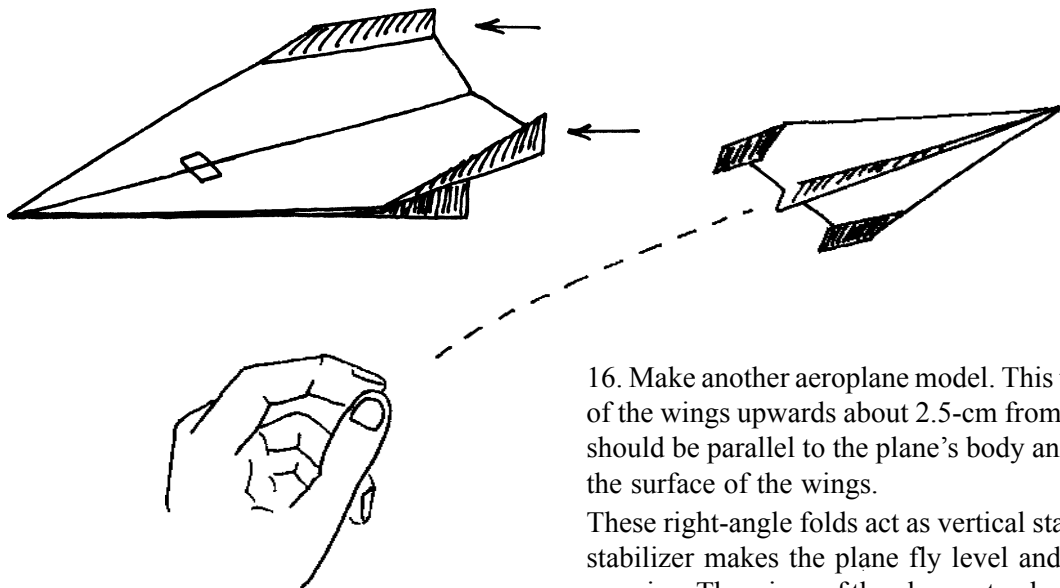

16. Make another aeroplane model. This time fold the edges of the wings upwards about 2.5-cm from the ends. The fold should be parallel to the plane's body and at right angles to the surface of the wings.

These right-angle folds act as vertical stabilizers. A vertical stabilizer makes the plane fly level and stops side-to-side swaying. The wings of the plane act as horizontal stabilizers. They help prevent bumpy, up-and-down movement.

## BIRD OF PEACE

A very elegant bird of peace can be made from a piece of stiff paper.  
This exquisite bird stands like a piece of sculptor.

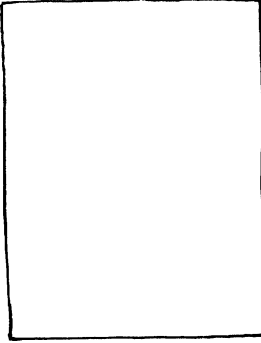

1. Take a thick  
30-cm x 15-cm  
card sheet.

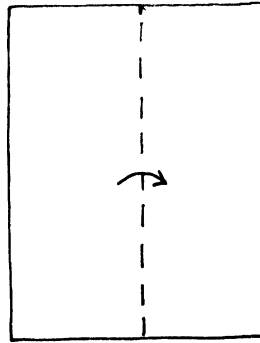

2. Fold it in half.

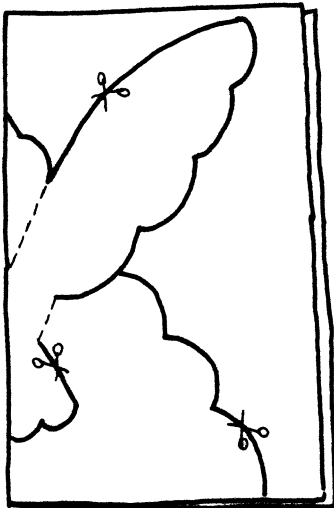

3. Mark out the  
bird of peace  
and cut only on  
the solid lines.  
Do not cut the  
dotted lines.

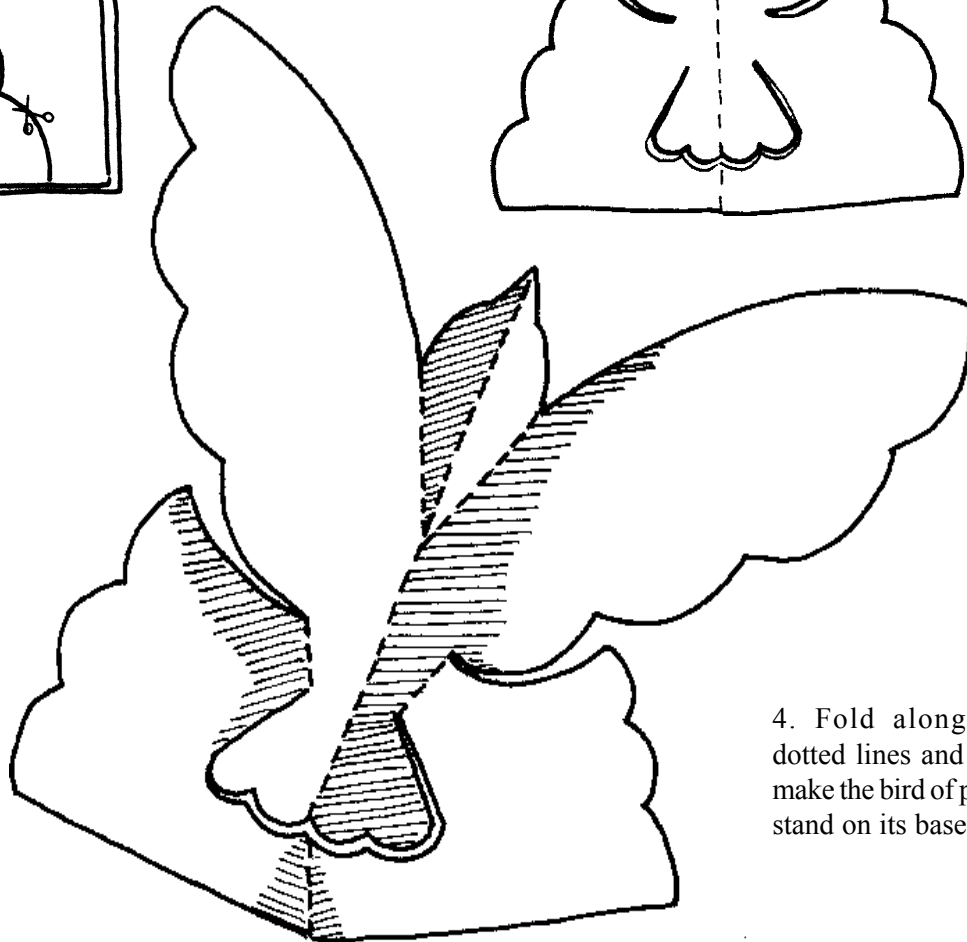
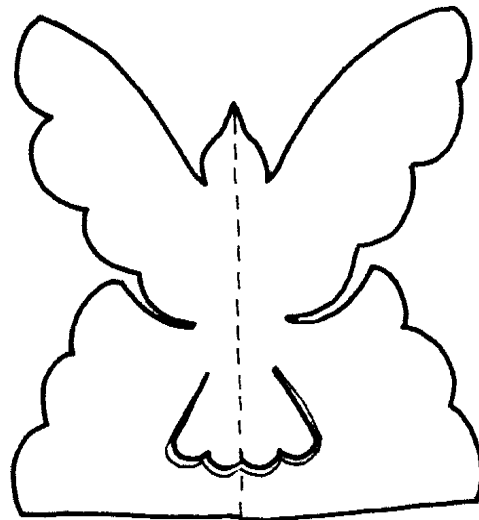

4. Fold along the  
dotted lines and then  
make the bird of peace  
stand on its base.

## FOLDING CALENDAR

This wonderful calendar was designed by the Sita School located on the outskirts of Bangalore.  
Children paint, print and sell these calendars by the thousands to raise money for their school.

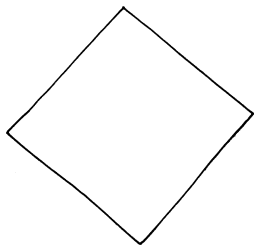

1. Take a square of paper 25-cm x 25-cm.

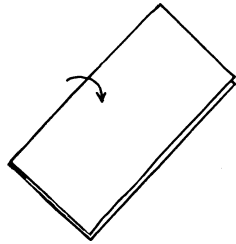

2. Fold it in half.

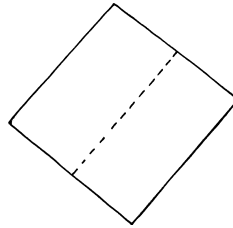

3. Open it.

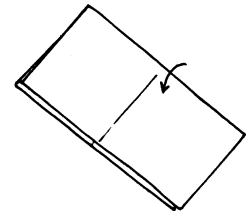

4. Again fold it in half.

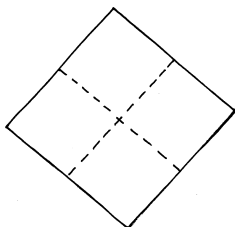

5. To make a plus sign.

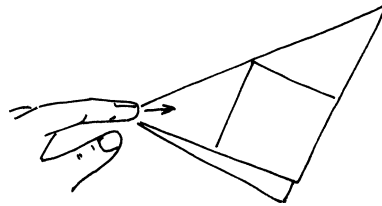

6. Now fold it along one diagonal and squash.

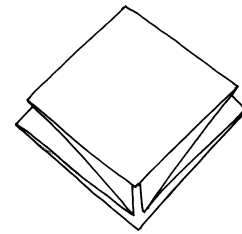

7. To make a small square springy shape. We need 3 such pieces.

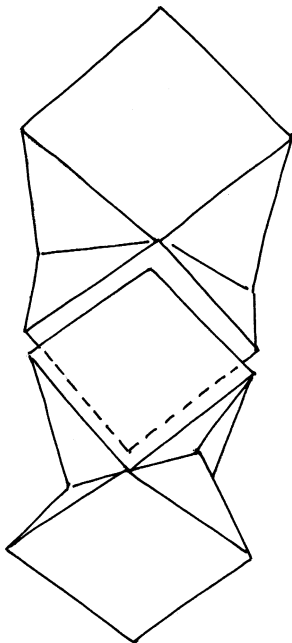

8. Take two such springy pieces. Glue one on top of the other.

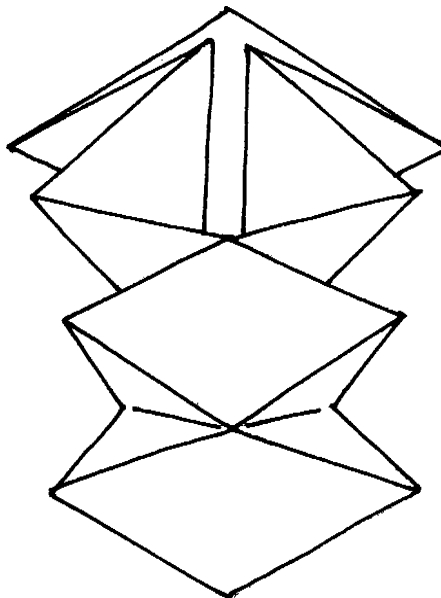

9. Similarly, glue the third springy piece to the previous two. The assembly will open and close like an accordion.

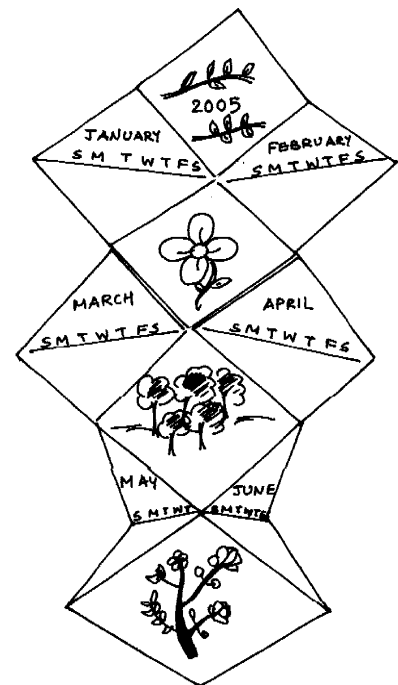

10. You could use this lovely foldable model to depict a picture story, calendar or whatever else you wish.

## SPRINGY CAT

This is a fun toy. It is very simple too.  
As you fan the cat with a notebook it jumps on its springy feet.

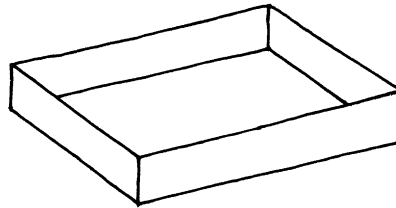
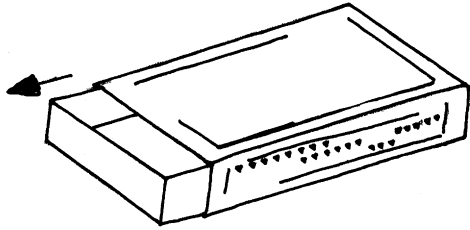

1. Remove the drawer from an empty match box. This will be the cat's body.

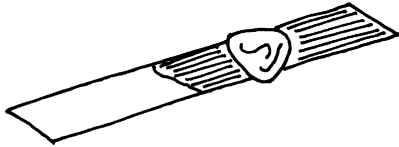

2. Take four strips of old Xerox paper 5-cm x 1-cm. Put glue on one end and wrap a light seed shell to make the cat's paw.

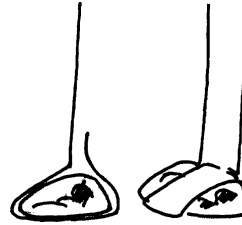

3. The details of making the paws are shown in this drawing.

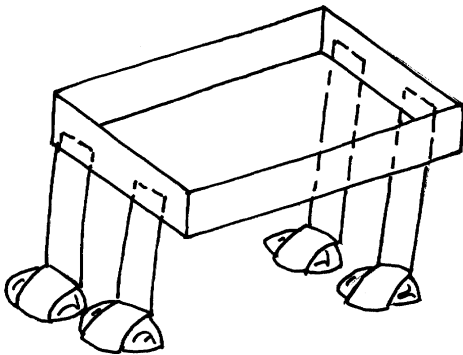

4. Glue the four legs to the match box drawer.

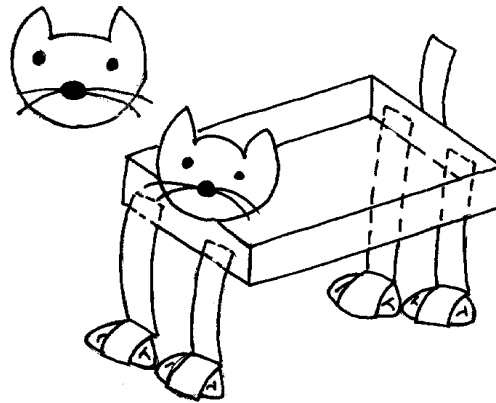

5. Fix a face and tail to make the cat look realistic.

6. Place the cat on the ground and fan it with a notebook. The cat will jump on its springy feet.

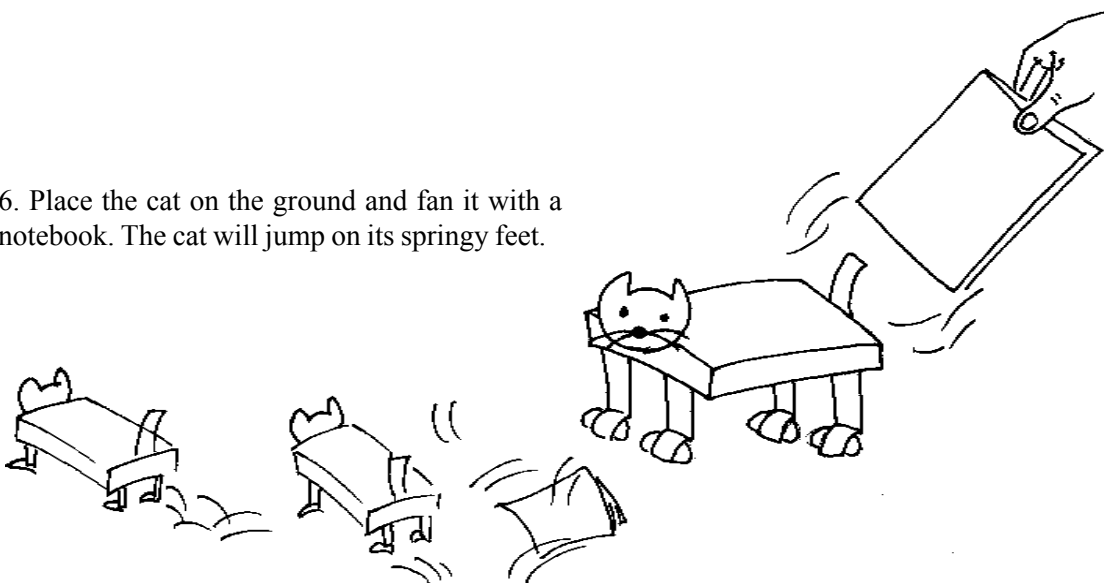

## PARTS OF A CIRCLE

Here is a very simple way to label the various parts of the circle.  
You will need two card sheet circles, some glue and a pen.

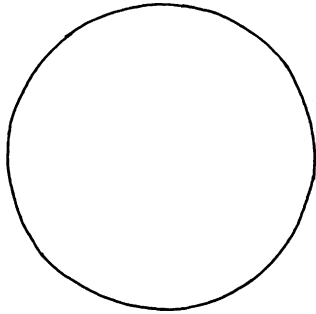

1. Cut two circles of 10-cm diameter from thin card sheet.

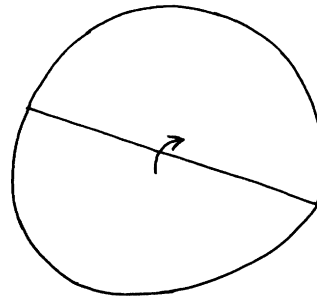

2. Fold them along the diameter.

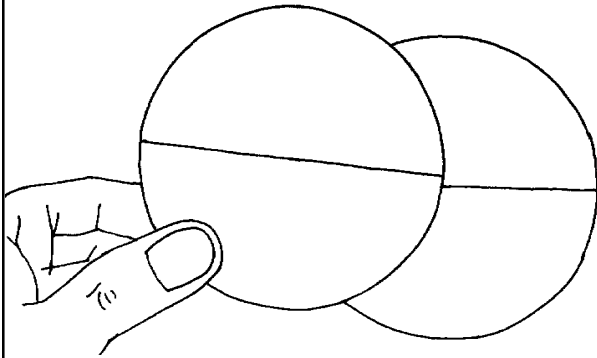

3. Stick the top half of both the circles, so that the lower part of the top circle can be lifted like a flap.

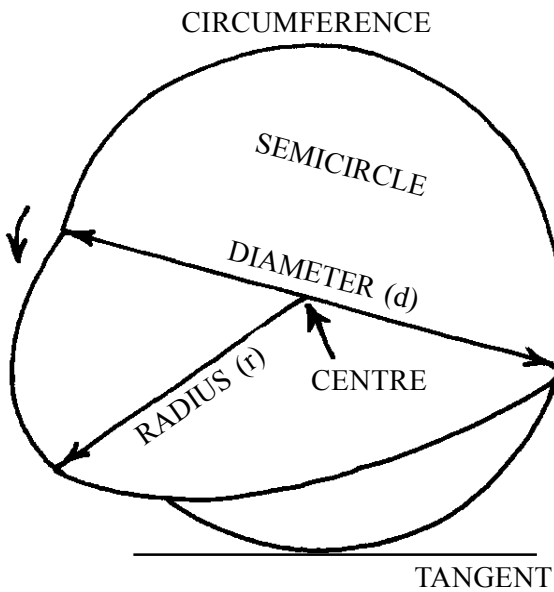

**TOP CIRCLE**

4. Now label the top circle as shown.

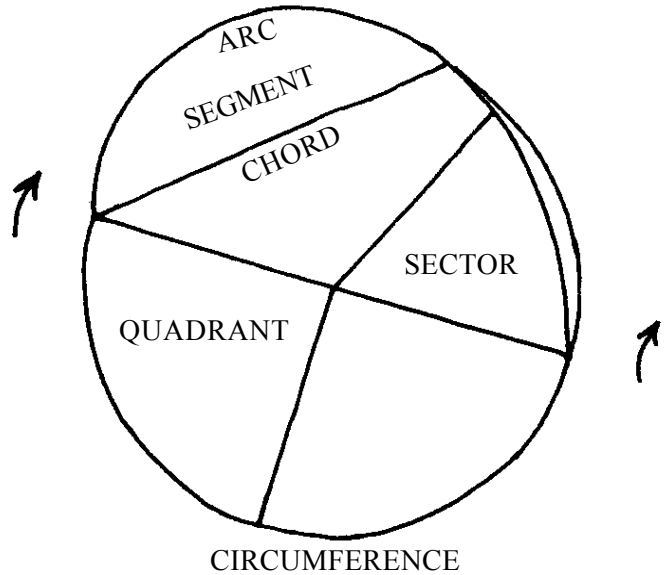

**BOTTOM CIRCLE**

5. Then lift the bottom flap and label the lower circle. This is a very simple way of showing the various parts of a circle.

## MY COUNTRY SCHOOL DIARY

Julia Weber Gordon

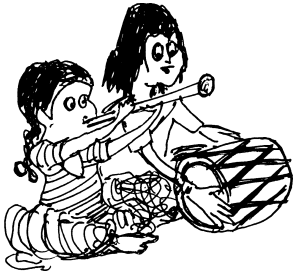

This book, though written in the late 1930's and published in 1946, has great meaning for us today. The government is trying to set up schools so that all children can go to school. This has been done at a frantic pace. New slogans are being coined, and new programmes are being announced without caring a damn as to why the previous programmes did not work. Special programmes have been designed for economically deprived sections, marginalized population and for the girl child. We mean well. But we are not likely to do much good, and may do more harm than good.

New programs, new materials, and even basic changes in organizational structure will not necessarily bring about healthy growth. A dynamic and vital atmosphere can develop when teachers who are ready to move be given the freedom and support to innovate. One must depend ultimately upon the initiative and resourcefulness of such teachers and this cannot be promoted by prescribing continuously and in detail what is to be done.

School change - if it is to be of lasting significance – must spring from the actions of teachers in classrooms, teachers who are able to help children live creatively because they are sufficiently whole human beings to live creatively themselves.

In short, the proper, the best, and indeed the only source of lasting and significant educational change must be the teacher in the classroom. *My Country School Diary* is for me eloquent proof of this. It tells what one teacher was able to do when given a chance and a little help. Certainly her situation looked hard and unpromising. Her school was a small, one-room country school in a poor and declining rural community, serving a group of children most of who were poor and many of whom were in other ways handicapped. She had very little money and only chose materials she or her students or friendly outsiders could make, or what she could get various educational services to give or lend her.

Miss Weber worked in a single teacher school located in a poor area. She taught 30 odd children ranging from class one to eight. Her experience tells us that we do not need enormous centralized schools in order to have quality education. Instead of small schools we have built giant school-factories, which we run, for the most part, like armies and prisons. The idea behind this was that small schools could not afford to have the kinds of equipment, materials, and specialized teachers that was necessary to get enough variety and depth in the children's learning. Miss Weber shows us that this need not have been so. In less than a month she and her pupils were already able to make their tiny school in its impoverished rural community a more beautiful and richer learning environment, more full of interesting things to look at and work with and think about, than most current schoolrooms ever are. When she and her students needed a book or some piece of equipment, they found out who might have it and then tried to borrow it. They got some skilled carpenters to help the older boys build a playhouse for the younger children. In one year her class of about thirty children borrowed seven hundred books from the country library! More than twenty books per pupil! Very few of our fancily equipped central schools get that kind of use out of their libraries; indeed, in many schools the library is so hedged about with rules and restrictions that students can hardly use it at all.

In education we cry too much about money. We waste large sums on show-off buildings; on unproductive administrative staffs; on expensive diagnostic and remedial specialists; on tons of identical and dull textbooks, and workbooks; and now audio-visual and computer labs.

The book contains another important lesson. Children need to grow in and into a community of older people that they can at least in part see, think about, and understand. They learn and grow best when their school is part of such a community, when their community comes into the school, when their learning touches at many points the lives, work, needs, and problems of people outside the school building.

The bare list of these things is eloquent. Miss Weber could play the harmonica; play the piano; do folk dances; sing songs; help design and build the playhouse; make and operate puppets and marionettes; play a number of games, particularly games that children of mixed ages could enjoy within limited space and given little equipment; make paper windmills; make scale drawings; identify many trees and plants; do Indian dances; grow flowers; make a rock garden; tell something about geology and identify rocks; tell Indian legends; sew; cook; make salt crystals; weave pot holders from rags; make furniture for the playhouse; design and make easels; identify and compare fabrics; work with clay; make pottery; draw and paint in various media; make plaster casts of animal tracks and identify some of them; sing carols in many languages; weave on simple looms; spin thread. And so on.

Along with these many minor abilities and skills, a teacher of young children, and probably students of any age, should have a wide range of knowledge, curiosity, and interest.

Other impressions stand out and carry other important lessons. As nice as the school was, how much more alive, natural, and real were the children when they got out on a Forestry Club picnic, a trip to the sea, or any one of their many trips out into the world around them.

It was often the case that the questions the children asked themselves were the questions from which came the most further investigation and learning. Miss Weber's school, like so many others, made nonsense of the worn-out old adage that children can't think because they haven't got the facts with which to, think. It was their desire to make sense of things, to find out how the world around them worked and how it came to work that way that led them to look for and collect facts. How vital it was that Miss Weber should have been free to build or, better yet, to grow the curriculum around the interests and concerns of the children. Of course she introduced ideas of her own, some of which worked better than others, some of which were successful only as long as she pushed them, and some of which the children took up and made their own. How vital it was, too, that she was not obliged to do the same things year after year, nor slogging through that old textbook and teacher's manual, but continually exploring new territory, so that her interest and enthusiasm were always alive, and being alive could awaken interest and enthusiasm in the children.

*From: John Holt's foreword to - MY COUNTRY SCHOOL DIARY*

## **THE ANIMAL SCHOOL : A PARABLE**

Once upon a time the animals decided they must do something decisive to meet the increasing complexity of their society. They held a meeting and finally decided to organize a school.

The curriculum consisted of running, climbing, swimming and flying. Since these were the basic behaviours of most animals, they decided that all the students should take all the subjects.

The duck proved to be excellent at swimming, better in fact, than his teacher. He also did well in flying. But he proved to be very poor in running. Since he was poor in this subject, he was made to stay after school to practice it and even had to drop swimming in order to get more time in which to practice running. He was kept at this poorest subject until his webbed feet were so badly damaged that he became only average at swimming. But average was acceptable in the school, so no body worried about that – except the duck.

The rabbit started at the top of her class in running, but finally had a nervous breakdown because of so much make-up time in swimming – a subject she hated.

The squirrel was excellent at climbing until he developed a psychological block in flying class, when the teacher insisted he start from the ground instead of from the tops of trees. He was kept at attempting to fly until he became muscle-bound – and received a C in climbing and a D in running.

The eagle was the school's worst discipline problem; in climbing class, she beat all of the others to the top of the tree used for examination purposes in this subject, but she insisted on using her own method of getting there.

The gophers, of course, stayed out of school and fought the tax levied for education because digging was not included in the curriculum. They apprenticed their children to the badger and later joined the groundhogs and eventually started a private school offering alternative education..

*Alas the author is unknown (a student at the University of Toronto)*

*From: MAKING THINGS – Ann Sayre Wiseman*

## RECTANGULAR PAPER BOX

With an old Xerox sheet you can fold a very useful box.  
You do not require scissors, glue, tape or staples for making it.

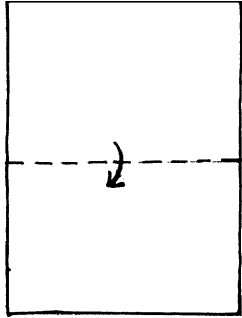

1. Take an A-4 Xerox paper sheet and fold it into half.

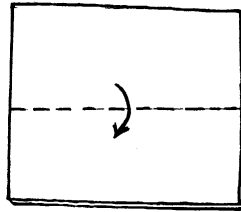

2. Fold it again into a quarter.

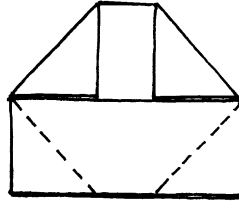

3. Open the model to make it half the A-4 size. Fold the top left and right hand corners.

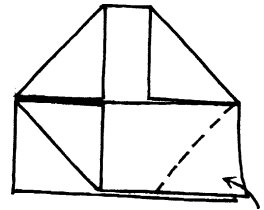

4. Fold the bottom left and right hand corners.

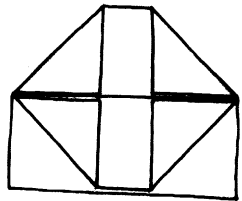

5. Lift the upper part and place it on top.

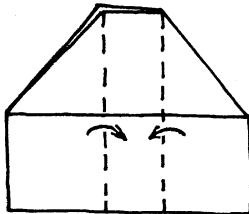

6. Fold along the two vertical dotted lines.

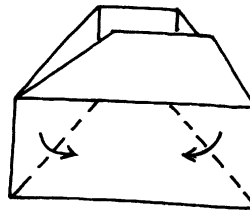

7. Fold along the two slanted dotted lines.

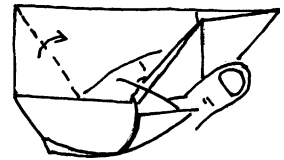

8. Insert your two thumbs in the house and lift it with the help of your index fingers.

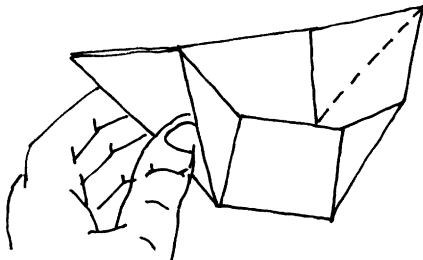

9. Form a triangular flap on the left hand.

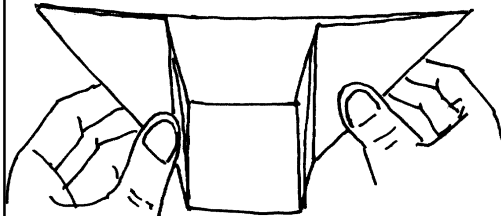

10. Similarly, form a triangular flap on the right hand.

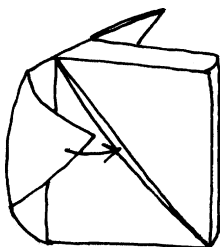

11. Tuck both the left and right hand flaps in the triangular pockets ....

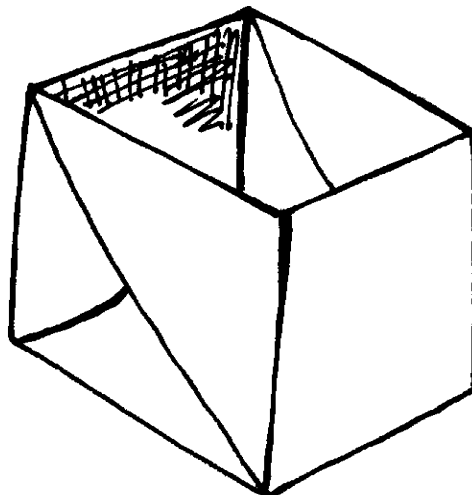

12....to form a lovely rectangular box.



## PAPER CLAPPER

I first saw this paper clapper with Dr. Anil Awchat of Pune.  
It is simple to make and great fun to play with.

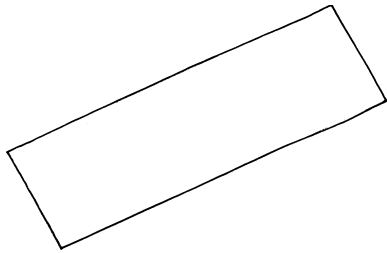

1. Take an old A-4 size Xerox paper and cut it in half along the length.

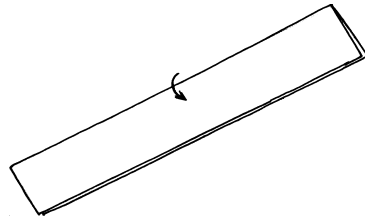

2. Fold it in half.

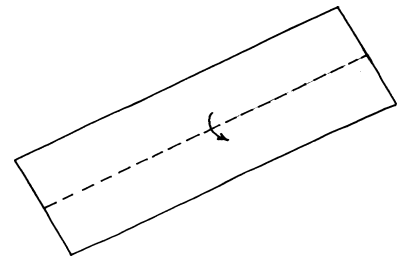

3. And open it again.

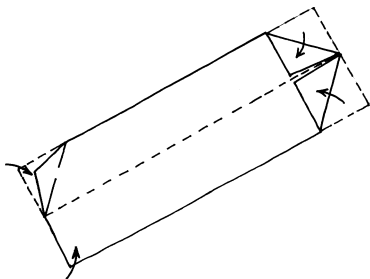

4. Fold all the four corners as shown.

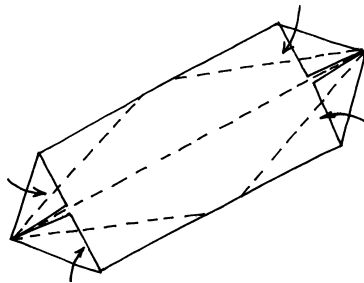

5. Once again fold inwards along the 4 slanting dotted lines.

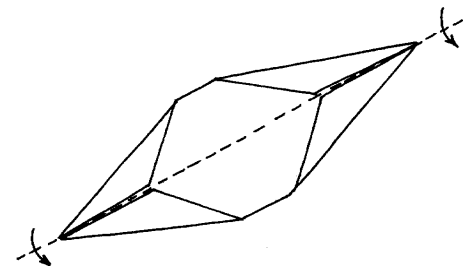

6. To arrive at this shape. Fold this shape in half.

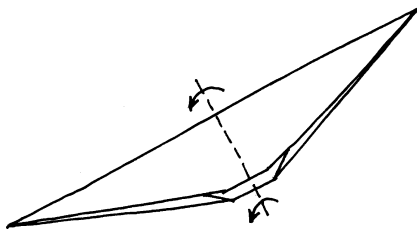

7. Again fold along the dotted line in half.

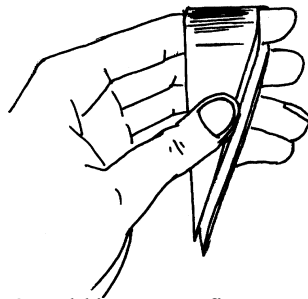

8. Fold it on your finger so that the fold is a bit rounded.

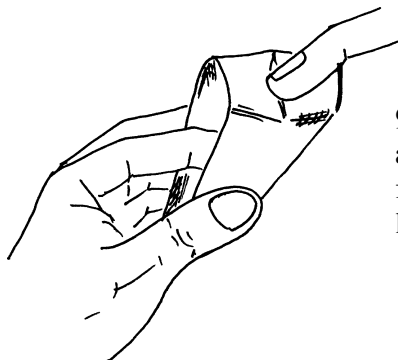

9. Make a crease at right angles on the rounded fold. This crease will act like a spring.

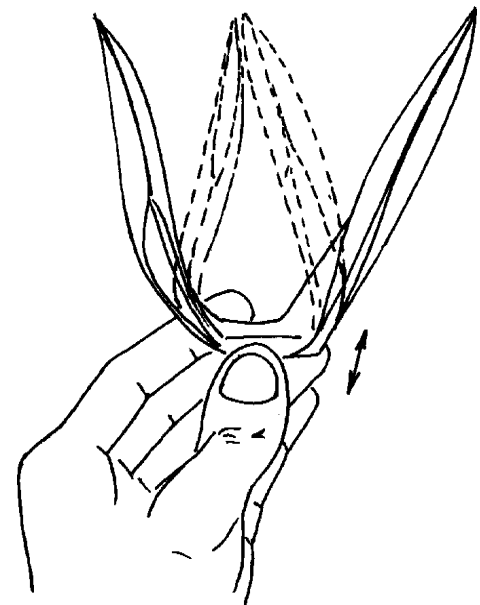

10. Now hold the clapper with your thumb and index finger as shown. On pressing and releasing your thumb and finger the clapper hands will clap.

## PAPER STRUCTURES

By simple experiments you can learn a great deal of paper engineering. These simple structures will give you a great feel for strength of structures.

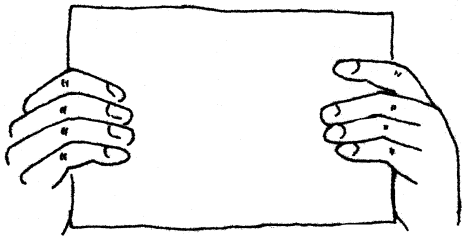

1. Fold a sheet of paper in a V shape and stand it on its edge on a table.

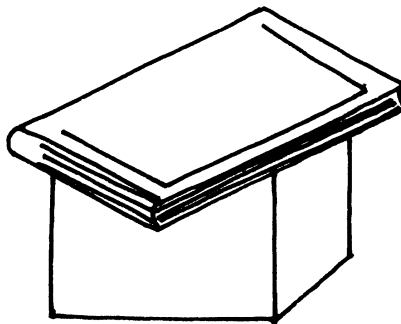

2. Place a book on top. Will it support the weight of the book? Maybe, the paper will hold its weight, but crumples when more weight is added.

3. Can you fold another sheet in a different way so as to support the weight of the book? The illustrations show a few ways of doing it.

Once you have folded several sheets into shapes that will support the book, there is still one other investigation you should make. Will all the structures be equally strong?

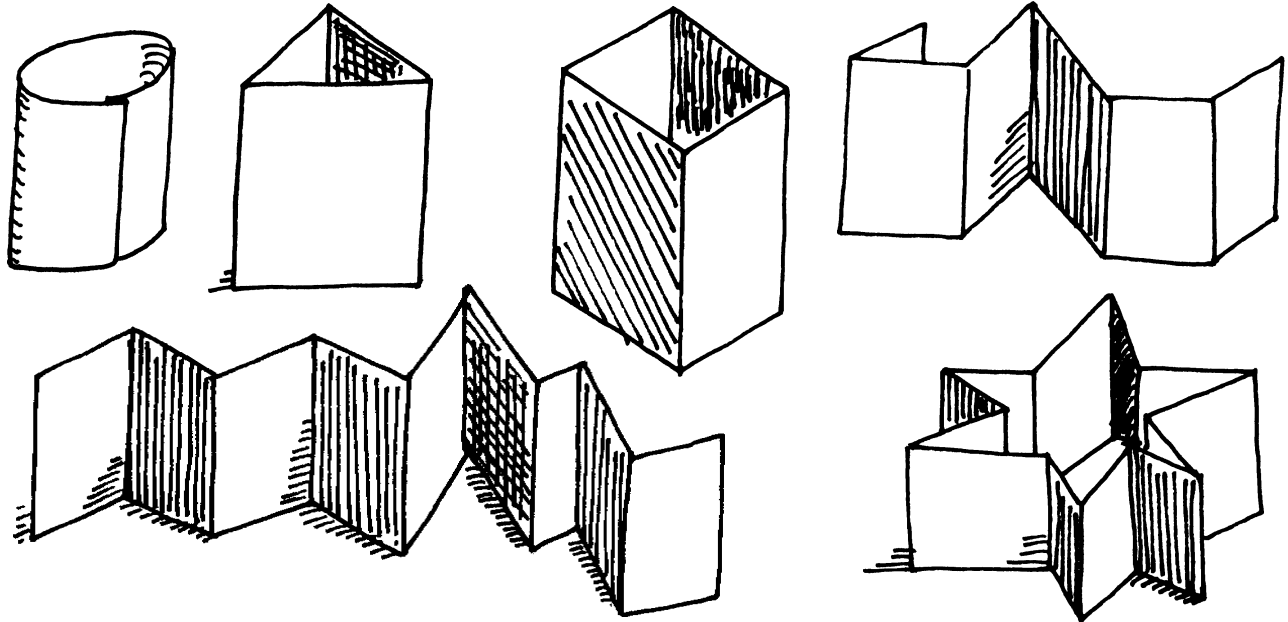

4. One of the ways of testing a structure is to keep loading the structure until it crumples or collapses. This gives us an inkling of the strength of the structure. You will find that one method of folding will support more books than another. By trial and error you will be able to decide that one structure is really stronger than all the others.

So, keep piling more and more books until the structure gives way. Once I folded a postcard (14-cm x 9-cm) into a 9-cm high cylinder. Then I loaded it with books. To my surprise the postcard cylinder could support a load of 4-kgs without crumbling!

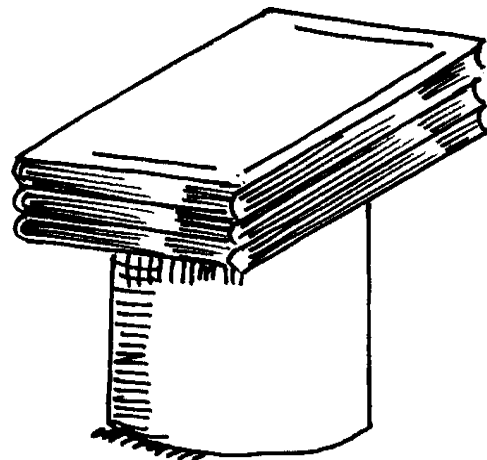

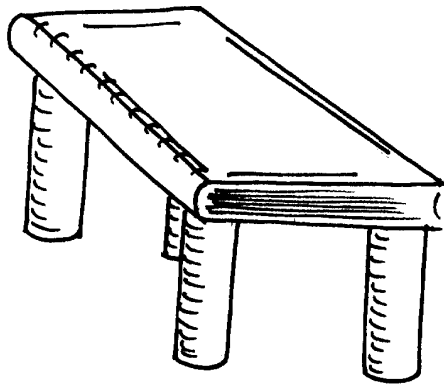

5. Roll five sheets of paper into tubes. All the tubes should have a 5-cm diameter and the same length. Roll them on a bottle or a can to ensure this. Glue or fasten the edges with tape so the tubes keep their shape.

Now stand one tube on the floor. Place a book on top. Balance the book carefully, and if necessary steady it with your hand. Place another book on top of this one. Continue placing books until your tower gives way and collapses. Note the number of books one tube supported before it collapsed. Now place the remaining four tubes on the floor like the legs of a table. Place one book on top like a table top. How many books do you suppose this table will support?

6. L, T, H, I and U are probably just the letters of the alphabet to you. But for engineers they are the very basic shapes for beams. Fold I, T, U and L model beams out of paper. Every one of these is stronger than a beam made from a flat sheet. Which of these shapes is the strongest? Test them by loading them appropriately.

In the picture are two plastic drinking glasses with approximately 15-cm of space between them. Lay a sheet of paper across their tops. Place another plastic glass on the bridge in the centre. Will the bridge support it?

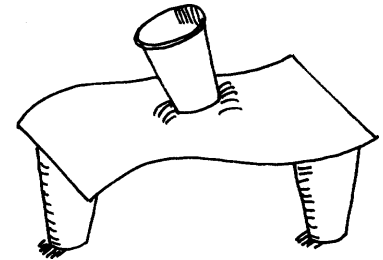

7. Fold, or roll papers into different shapes. Place each in turn across the glasses. Press down on the centre of each bridge with your finger, until it collapses. You will discover that your finger is very sensitive and you can decide which shape withstands the most pressure before it collapses. Which shape turned out to be the strongest?

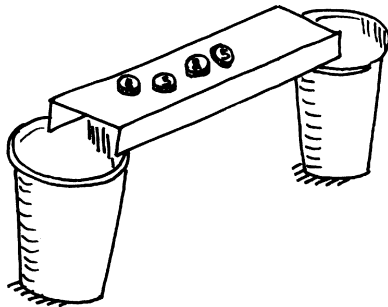
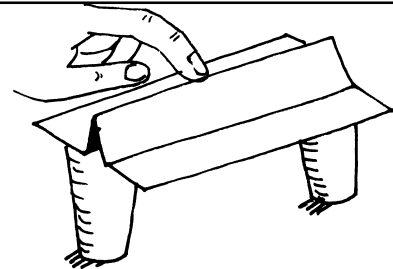

8. What is a beam? It is a structure that can stand on its own without any outside help. This is something we need for making a bridge. Cut a sheet of paper 25-cm x 10-cm. Fold 2.5-cm strips on both sides to make a long tunnel. Rest the ends of your bridge. Now place one-rupee coins on the centre of the bridge until it collapses. Count the coins.

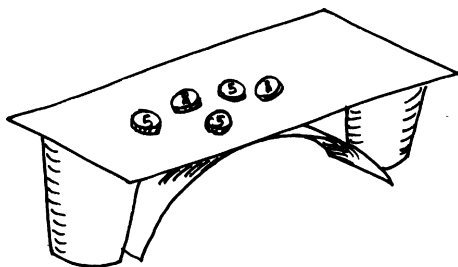

9. It is simple to make this model arch bridge. Cut a length of paper such that when it makes an arch it is just the height of the glasses. Place a flat strip of paper on top of it. Again lay one-rupee coins on top of this bridge and test it. Does it support more weight or less weight than a beam bridge?

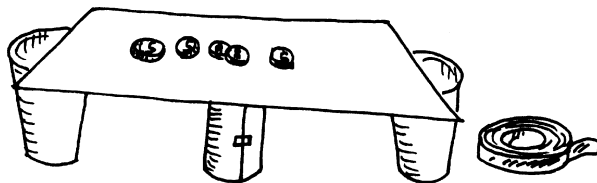

10. The most common bridge is the pier or the pile bridge. You must have seen a bridge like this in your area. Roll a cylinder the exact height of the glasses and place it between the glasses. Place a strip for the road on top. How strong is this bridge?

## IT LEVITATES, IT SPINS, IT WRITES!

This is simply a terrific toy. You can while away hours playing with it.

It also gives you a tremendous feel of what magnetic levitation is all about. It costs less than ten rupees.

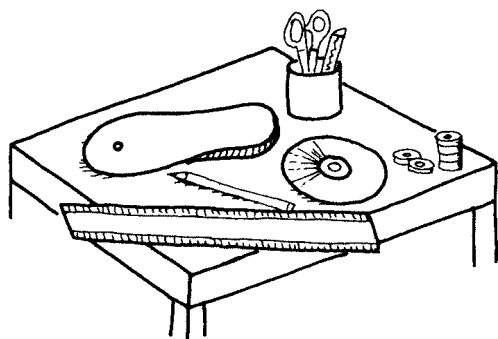

1. You need an old rubber slipper, discarded CD, 6 ring magnets (17.5-mm OD, 7.5-mm ID, 3-mm thick - they cost 1 rupee each), one pencil and few simple hand tools.

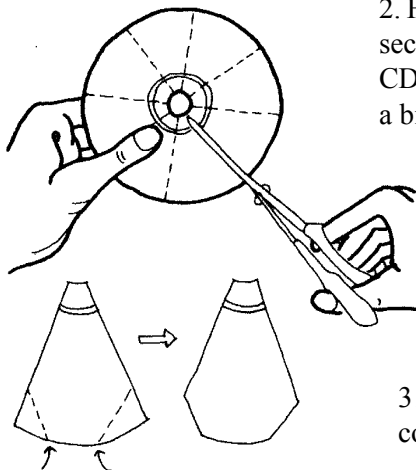

2. First mark out 8 equal sectors in the discarded CD. Cut one sector using a big scissors.

3. Cut the lower corners at an angle.

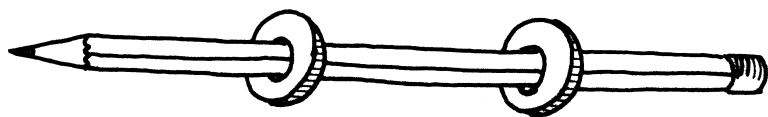

4. Take two ring magnets and press fit them in a pencil. They are just right to fit into a pencil. You might have to scrape the pencil a bit. The polarities of the magnets do not matter.

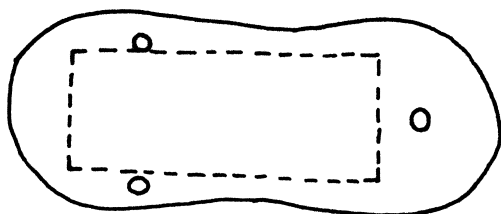

5. Cut a rectangle 15-cm x 7.5-cm from an old rubber slipper.

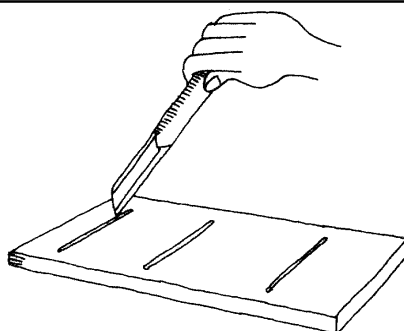

6. From one end mark out lines at 2-cm, 6.5-cm and 12.5-cm.

Make 5-cm wide cuts on these lines.

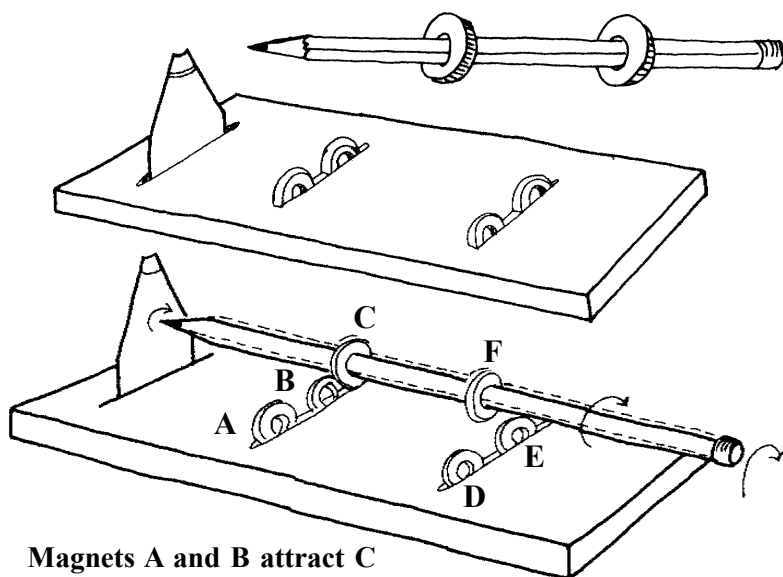

**Magnets A and B attract C**  
**Magnets D and E repel F**

7. Now insert the CD piece. Place 2 ring magnets in the rubber slit next to the CD. These magnets must have poles which attract the pencil magnet close to the writing end. Insert two more ring magnets in the other slits. These magnets must repel the pencil magnet (away from the writing end)

8. If you now place the pencil it will levitate in air with its tip resting on the CD. Now twirl the rear end of the pencil and it will keep spinning for a long time.

You may have to adjust the positions of the pencil magnets a bit to get the pencil to levitate.

*(Magnets can be ordered from Hindustan Magnet House, Pune Tel (020) 2551-1623, 2551-1021)*

Pix: Shibika Chowdhary

## ROTATING LOOP OF THREAD

This toy was found to be very useful with children suffering from asthma.  
Children have fun blowing. They simultaneously exercise their lungs.

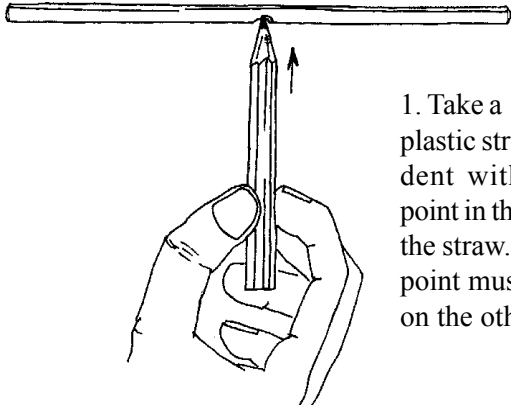

1. Take a 15-cm long plastic straw. Make a dent with a pencil point in the middle of the straw. The pencil point must not show on the other end.

2. Put the pencil point in this dent at an angle.

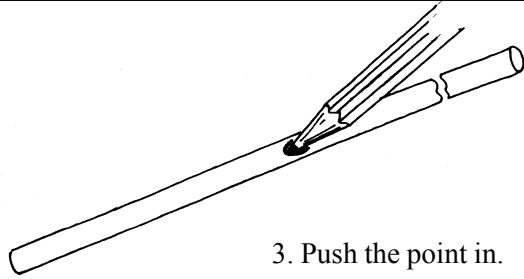
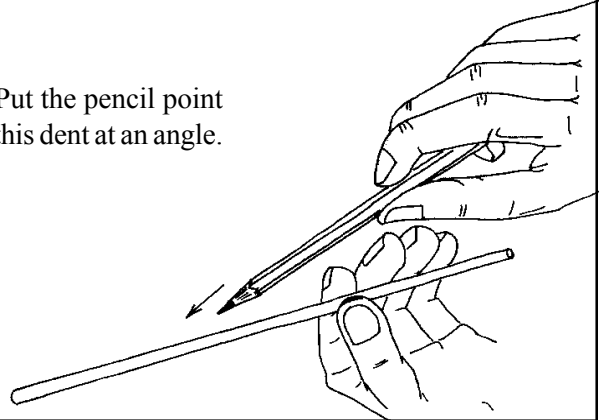

3. Push the point in.

4. Keep pushing the pencil point and rotating the pencil to make a big rounded hole. There will be no sharp edges in this hole.

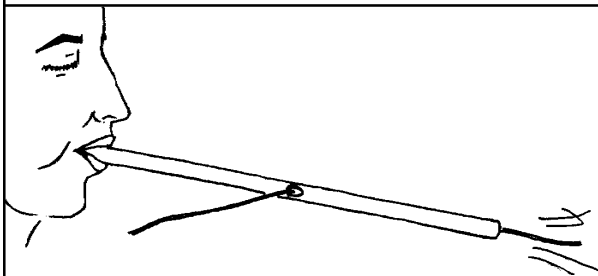
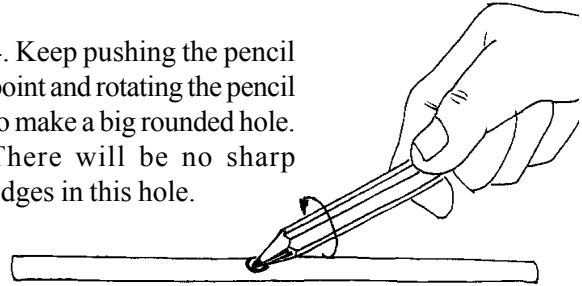

5. Take a 50-cm long piece of cotton thread. Place one end of the thread in this hole and gently blow from the other end to push the thread through.

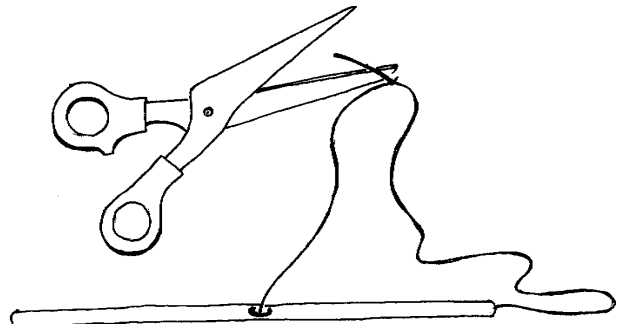

6. Tie a small knot at the ends of the thread. Trim the tail of the knot.

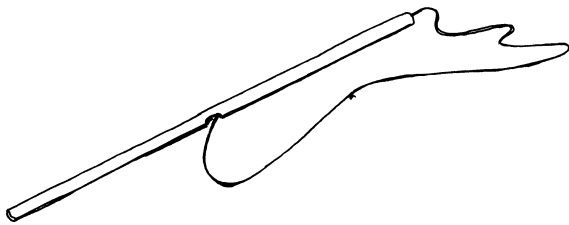

7. You will have a loop of cotton thread hanging from the straw.

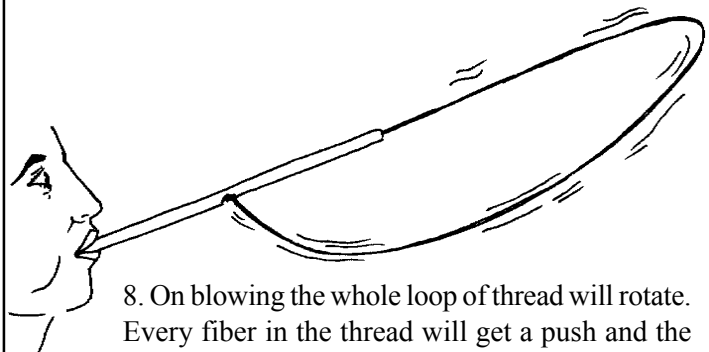

8. On blowing the whole loop of thread will rotate. Every fiber in the thread will get a push and the whole loop of thread will go round-and-round. If the knot gets stuck in the hole then either make the knot small or make the hole bigger.

# ANIMAL PICTURES

A whole picture might look difficult, but it can easily be made in steps.

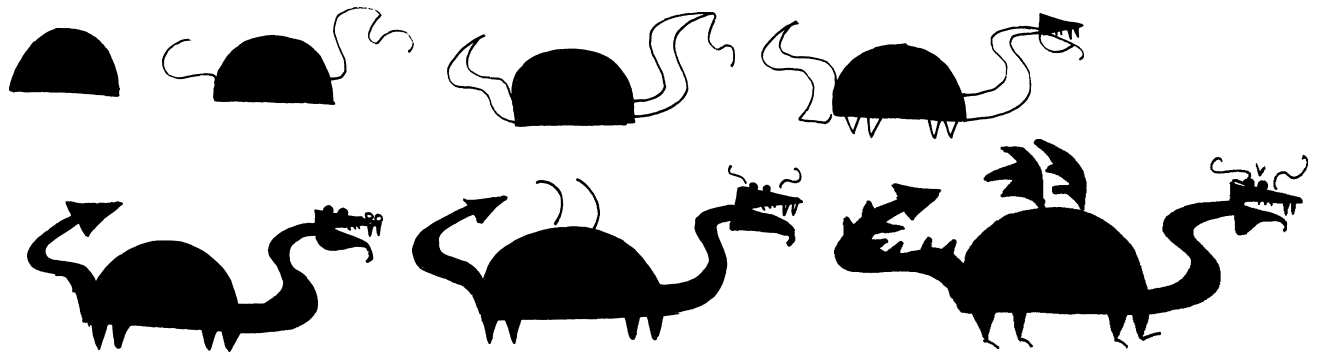
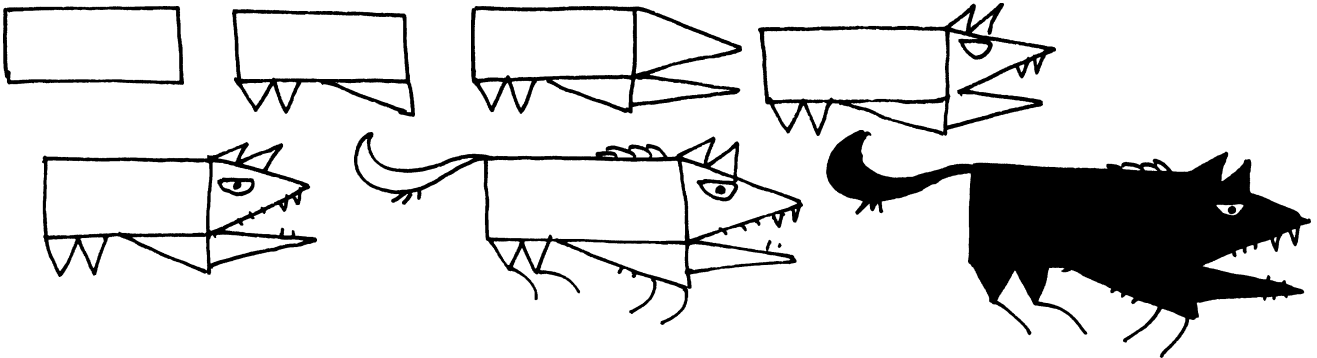
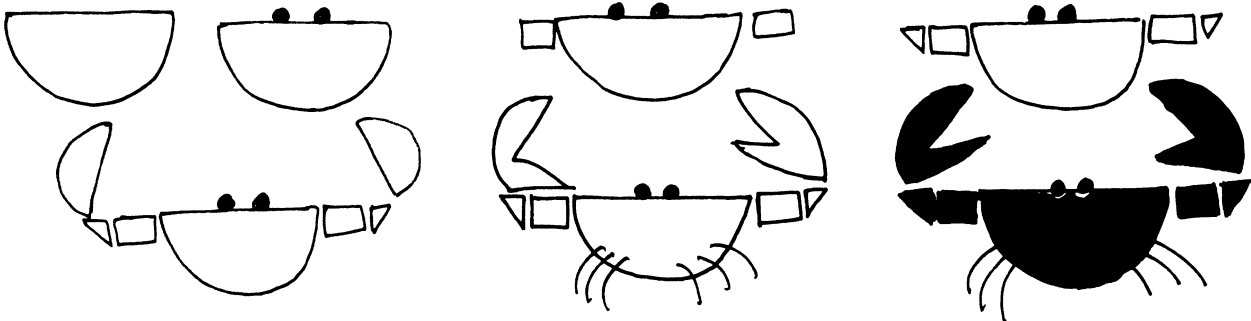
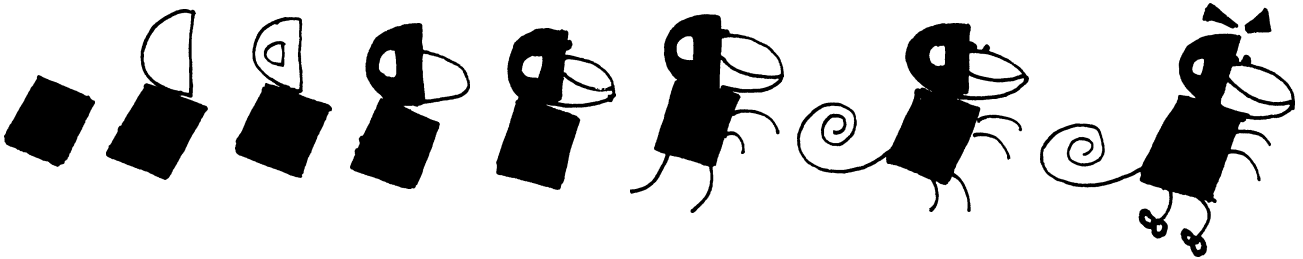
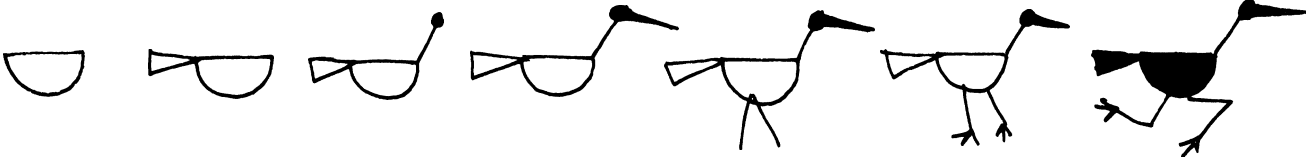
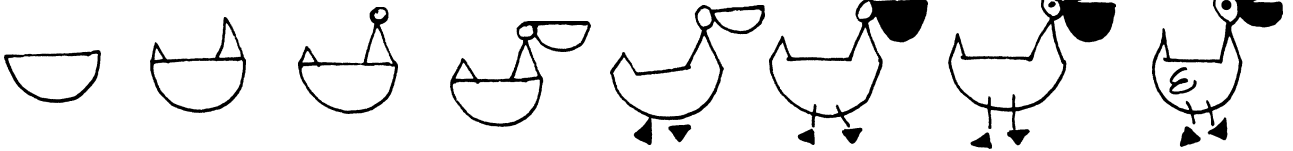

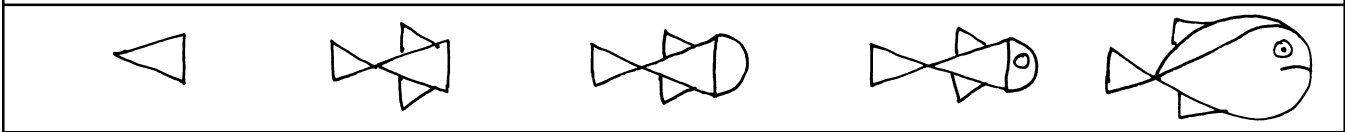
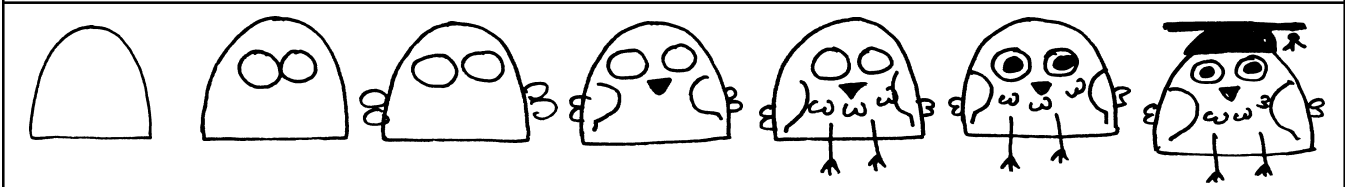
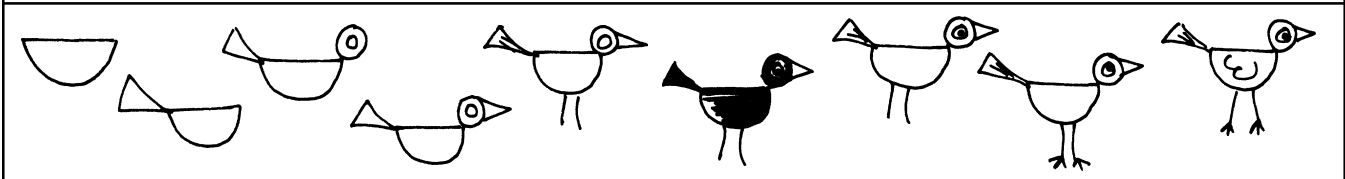
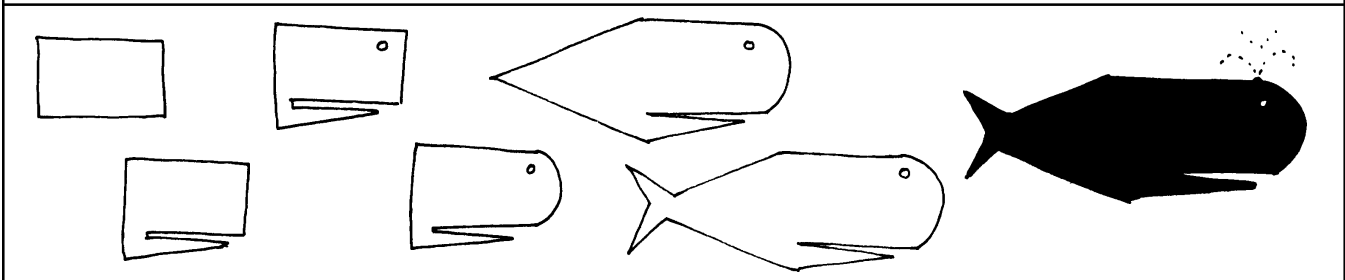
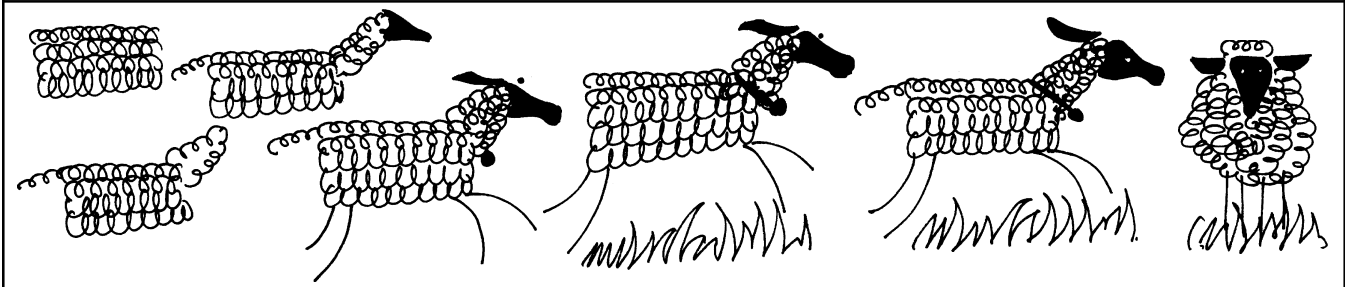
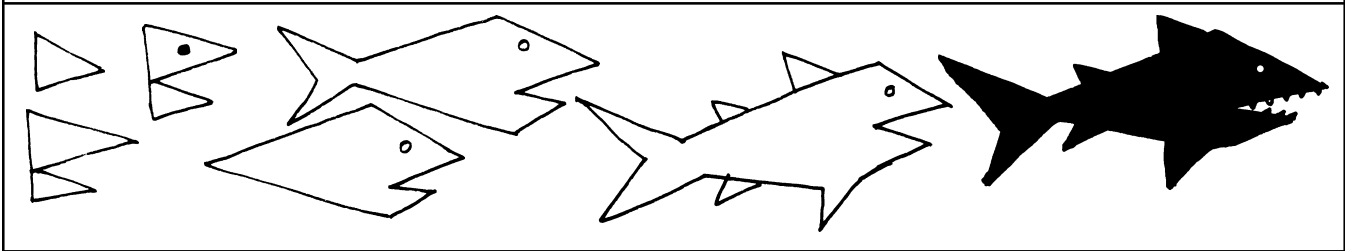
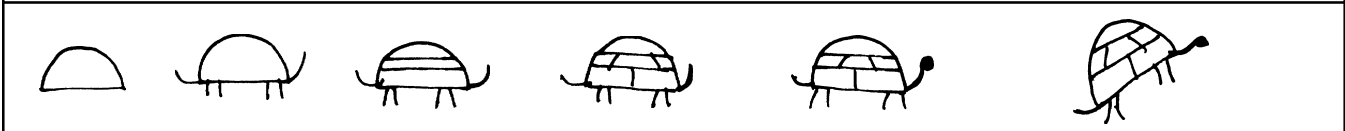
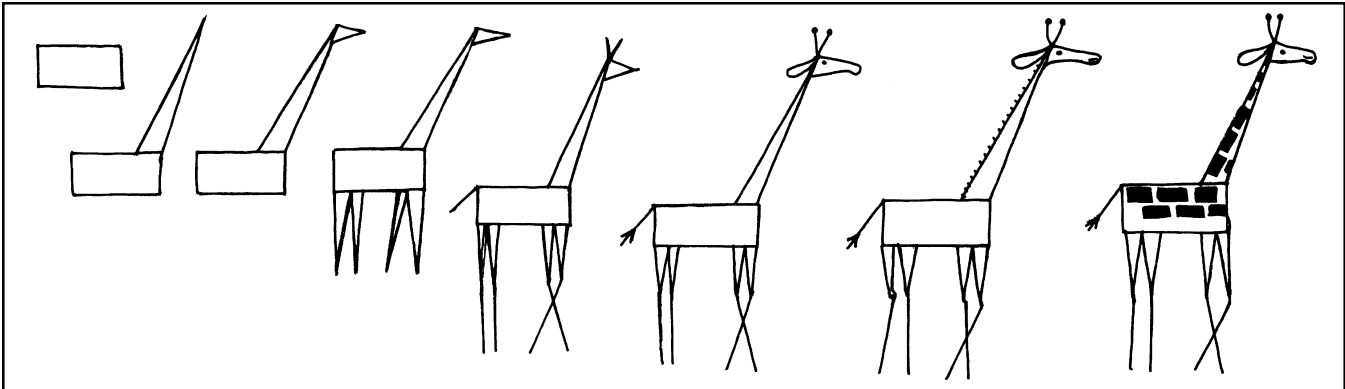

## ALBERT EINSTEIN'S LEGACY

The great scientist was also a pacifist and a human rights advocate.

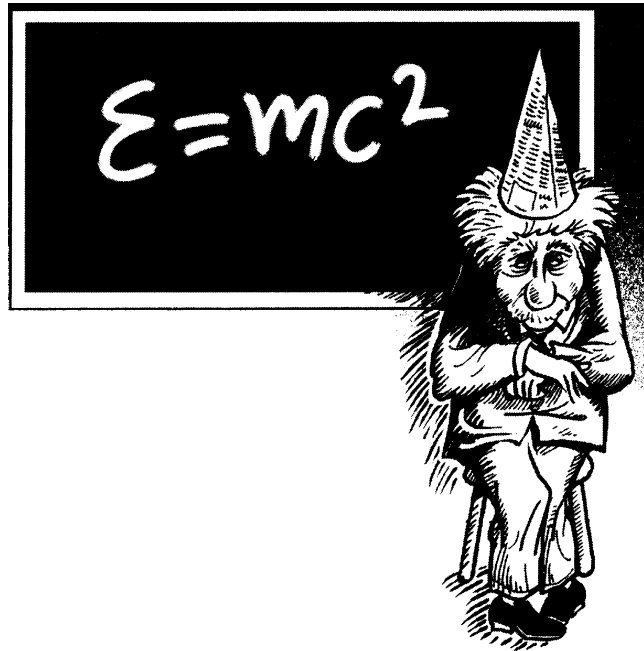

Einstein had a special gift, a talent for perceiving old things in new ways. He posed deep challenges to conventional wisdom. Einstein was a saintly and honoured figure - one scientist the average person could readily name. In part because of his scientific accomplishments, at least dimly grasped by the public, in part because of his courageous positions on social and political issues and in part because of his benign personality, Einstein was revered and admired throughout the world. For many young people who took up science he was a role model.

Einstein early childhood would give hope to every dimwit. "My parents," he recalled later, "were worried because I started to talk comparatively late, and they consulted the doctor because of it...I was at that time...certainly not younger than three." He was an indifferent student at elementary school, where he said the teachers reminded him of drill sergeants. In Einstein's youth, bombastic nationalism and intellectual rigidity were the hallmarks of European education. He rebelled against the dull, mechanized methods of teaching. "I preferred to endure all sorts of punishments rather than learn to gabble by rote." Einstein was always to detest the rigid disciplinarians, in education, in science and in politics.

When Einstein was five years old he was stirred by the mystery of the compass. Einstein was largely self educated. Not one of his teachers seems to have recognised his talents. At the Munich Gymnasium, the city's leading secondary school, one of the teachers told him, "You'll never amount to anything, Einstein." At age 15 it was strongly suggested that he leave school. The teacher observed, "Your very presence spoils the respect of the class for me." Einstein accepted the teacher's suggestion with gusto and as a school dropout spent many months wandering through northern Italy. Throughout his life Einstein preferred informal dress and manner. Had he been a teenager in the late 1960's rather than the 1890's, he would certainly have been called a hippie.

Einstein resented the prescribed curriculum. He cut classes and tried to pursue his true interests. He later wrote, "The hitch in this way, of course, the fact that you had to cram all this stuff into your mind for the examination, whether you liked it or not." The final examination, "had such a deterring effect on me... I found the consideration of any scientific problem distasteful to me for an entire year... It is little short of a miracle that modern methods of instruction have not completely strangled the holy curiosity of inquiry, because what this delicate little plant needs most, apart from the initial stimulation, is freedom; without that it is surely destroyed...I believe that one could even deprive a healthy beast of prey of its voraciousness, if one could force it with a whip to eat continuously whether it was hungry or not..." His remarks should be sobering to those who are engaged in the education of science. One wonders how many potential Einstein's have been permanently discouraged through competitive examinations and the forced feeding of curricula.



Later Einstein joined the Patent Office. He was to later recall the Patent Office as “that secular cloister where I hatched my most beautiful ideas.” On several occasions he was to suggest to colleagues that the occupation of a lighthouse keeper would be a very suitable position for a scientist - because the work would be comparatively easy and would allow the contemplation necessary to do scientific work.

Einstein was born in a conventional Jewish home. But at age 12 his belief in religion came to an abrupt end. “Through the reading of popular scientific books I soon reached the conviction that much of the stories of the Bible could not be true. The consequence was a positively fanatic free thinking coupled with the impression that the youth is intentionally being deceived by the State through lies; it was a crushing impression. Suspicion against every kind of authority grew out of this experience, a sceptical attitude ... which has never left me again.”

Einstein who described himself as a socialist, became convinced that World War I was largely the result of scheming and incompetence of “the ruling classes,” a conclusion which many perceptive observers agreed. He became a pacifist. When other German scientists enthusiastically supported their nation’s military enterprises, Einstein publicly condemned the war as “an epidemic delusion.” Only his Swiss citizenship prevented him from being imprisoned, as indeed happened to his friend and philosopher Bertrand Russell in England, at about the same time and for the same reasons. Einstein’s views on the war did not increase his popularity in Germany. The Nazis burned Einstein’s scientific works in public bonfires. An all out attack was launched on Einstein’s scientific stature. Leading the attack was the Nobel laureate physicist Philipp Lenard.

After leaving Germany, Einstein learned that the Nazis had placed a prize of 20,000 marks on his head. (“I didn’t know it was worth so much.”). He took an offer at the Institute of Advanced Studies at Princeton. He was to remain there for the rest of his life. When asked what salary he thought fair, he suggested \$ 3,000. Seeing a look of astonishment pass over the face of the representative of the Institute, he concluded he had proposed too much and mentioned a smaller amount. His salary was set at \$16,000, a very good salary for the 1930’s.

Einstein was a powerful defender of civil liberties in the United States during the darkest period of McCarthyism in the early 1950’s. He held that there was “a duty in refusing to cooperate in any undertaking that violates the Constitutional right of the individual.”

His principal recreations throughout his life were playing the violin and sailing. In those years Einstein looked like and in some respects was a sort of an aging hippie. He let his white hair grow long and preferred sweaters and leather jackets to a suit and a tie, even when entertaining famous visitors. He was often available to the public, sometimes being willing to help high school students with their geometry - not always successfully. In the best scientific tradition he was always open to new ideas but required that they pass rigorous standards of evidence.

Einstein’s last public act was to join with Bertrand Russell and many other scientists and scholars in an unsuccessful attempt to bring about a ban on the development of nuclear weapons. He argued that nuclear weapons had changed everything except our way of thinking. In a world divided into hostile states he viewed nuclear energy as the greatest menace to the survival of the human race. “We have the choice,” he said, “to outlaw nuclear weapons or face general annihilation... Nationalism is an infantile disease. It is the measles of mankind.... Our schoolboys glorify war and hide its horrors. They inculcate hatred in the veins of children. I would teach peace rather than war, I would inculcate love rather than hate.”

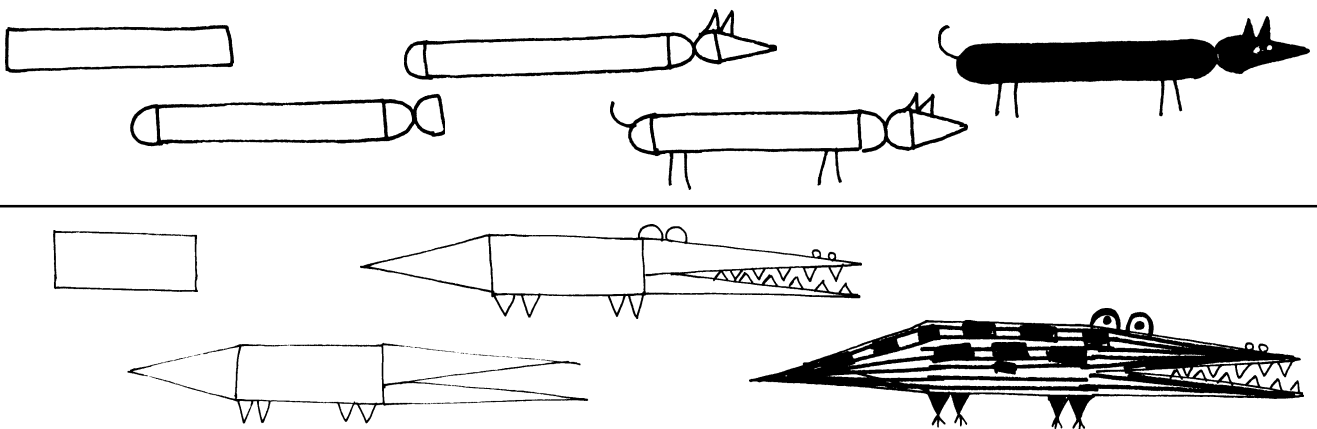

## HUMMING HANGER

Using an old hanger and a piece of cardboard, few rubber bands and thread, you could make a 'roarer' or a hummer.

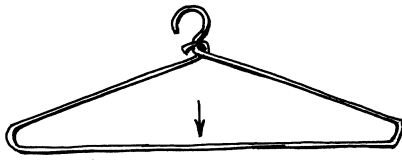

1. Take a wire hanger. Hold the hook with one thumb and pull down the middle point of the big side to make a diamond shape.



2. Stretch a few rubber bands and slide them on the wire frame.

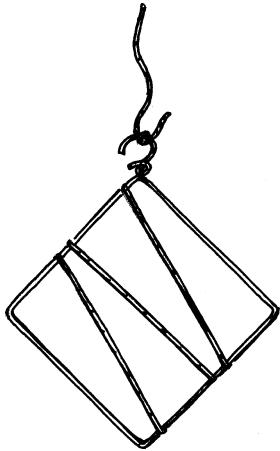

3. Tie a strong thread to the hook of the hanger. Hold one end of the frame and swing the hanger to make a humming noise.

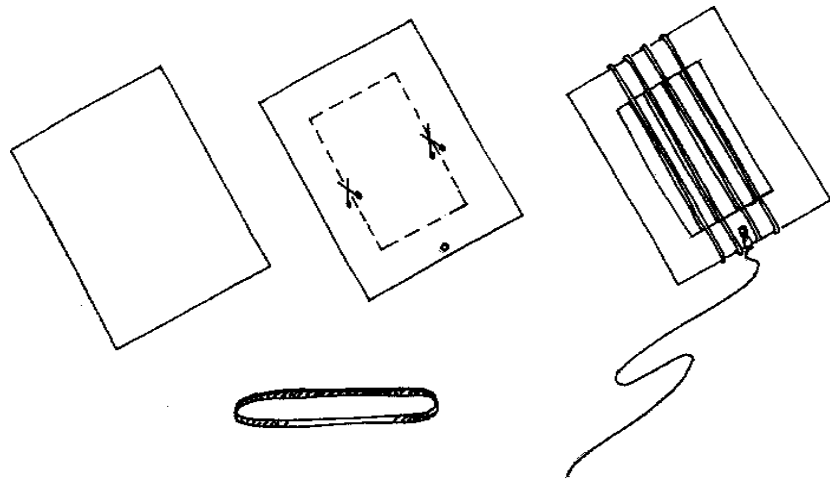

4. Instead of a wire hanger you could repeat this activity with a cardboard frame. Cut the middle of the cardboard and stretch rubber bands on this frame and then swing it.

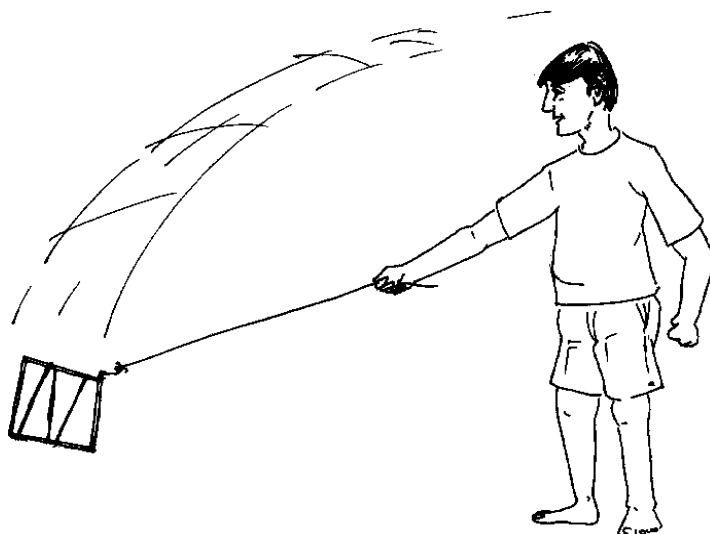

5. What determines the 'hum'?

- The stretch of the rubber bands.
- The pattern of the rubber bands on the frame.
- The speed of rotation.

## SPINNING BOTTLE

This simple experiment demonstrates Newton's third law of motion - that every action has an equal and opposite reaction.

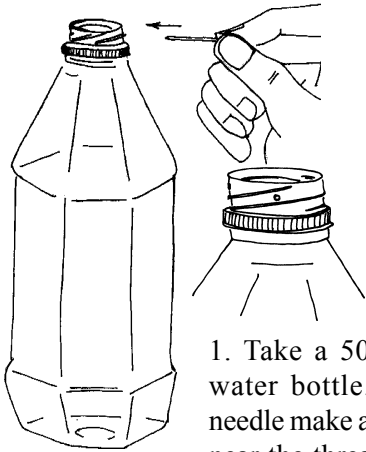

1. Take a 500-ml plastic water bottle. With a big needle make a through hole near the threaded end.

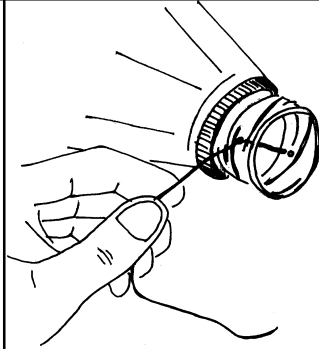

2. Weave a 8-cm thread through this hole and tie a knot to make it a loop.

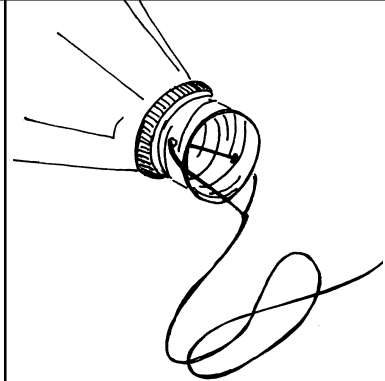

3. Tie a long thread to this loop.

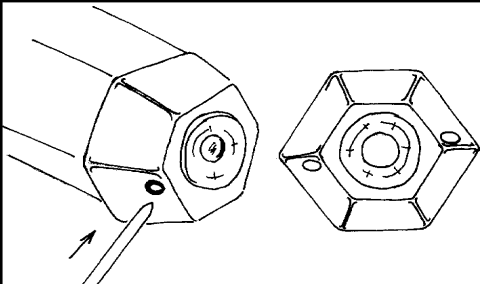

4. With a big nail make a hole on the vertical wall of the bottle near its base. Make another hole at the other end.

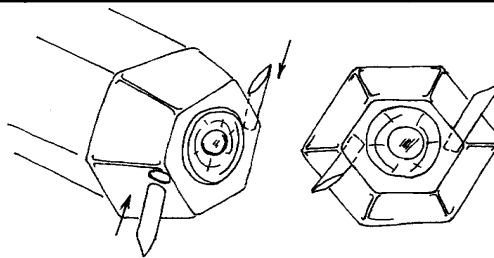

5. Take two pieces of stiff plastic straw 3-cms long (old *Add Gel* refills are ideal). Cut one end of these pieces at a slant. Press them in the holes in the orientation shown.

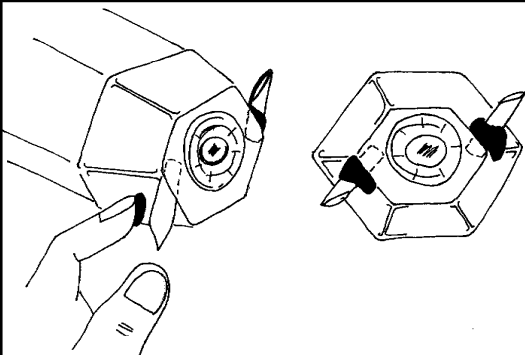

6. Apply *M-seal* or some other adhesive (kneaded wheat flour does well) to prevent leakage.

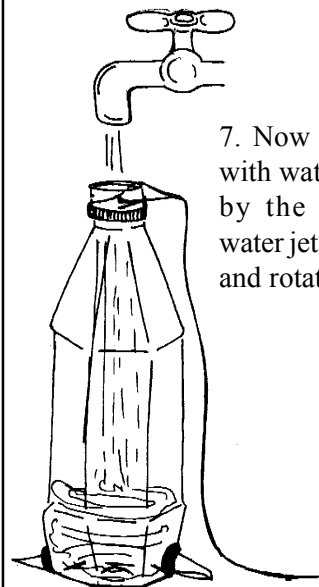

7. Now fill the bottle with water and hang it by the thread. Two water jets will gush out and rotate the bottle.

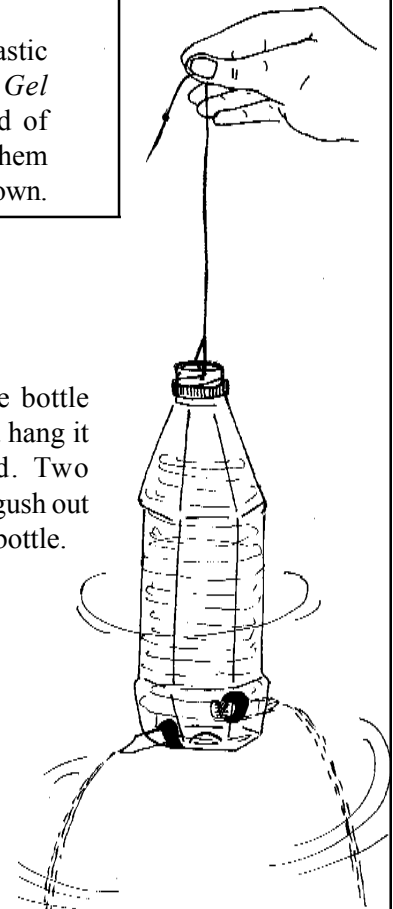

## WHICH HOLDS MORE?

A number of elegant science experiments can be done with postcards. This fundamental experiment is essential to understand the relationship between area and volume.

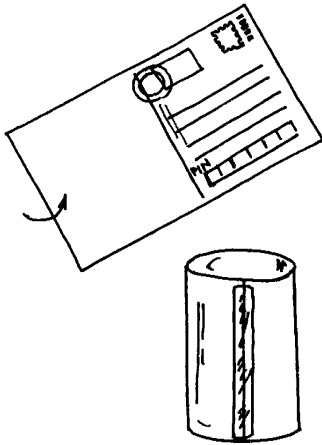

1. A postcard is always 14-cm x 9-cm. This is a standard. Fold a postcard and bring its two short edges together. Tape the edges to make a 9-cm high cylinder.

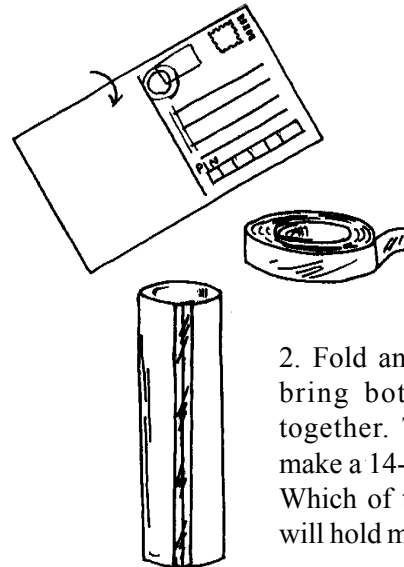

2. Fold another postcard and bring both its long edges together. Tape the edges to make a 14-cm high cylinder. Which of these two cylinders will hold more sand?

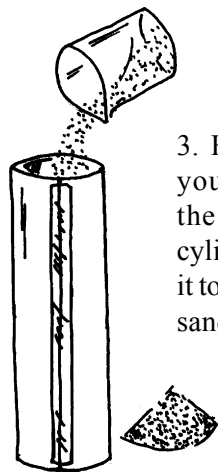

3. Here is how you test. Take the 14-cm tall cylinder and fill it to the top with sand.

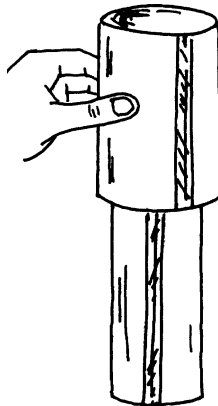

4. Then slip the fat / short 9-cm high cylinder on the tall / thin cylinder.

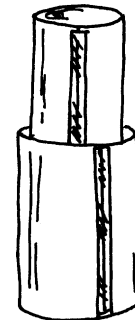

5. The thin cylinder will now be inside the fat cylinder.

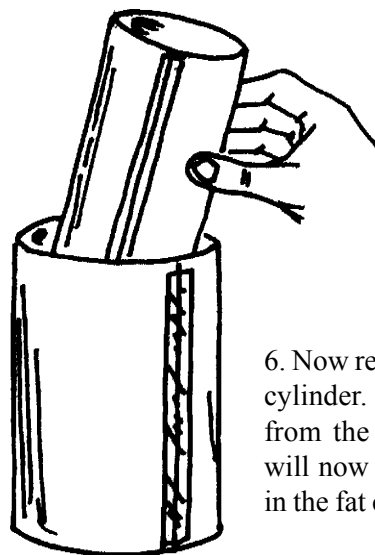

6. Now remove the tall cylinder. All the sand from the tall cylinder will now be contained in the fat cylinder.

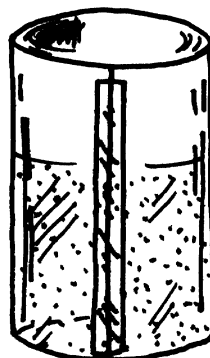

6. You will be surprised to find that the fat cylinder is only two-thirds full. Why?

The volume of a cylinder depends on its area of cross-section and its height. The area of the circle varies as the square of its radius. The fat cylinder has a larger radius. So, the square of the radius really makes a lot of difference and makes its volume larger.

## SIMPLE RAIN GAUGE

Using a plastic throw away water bottle you can make a very simple rain gauge.  
It costs almost nothing to make this nice apparatus.

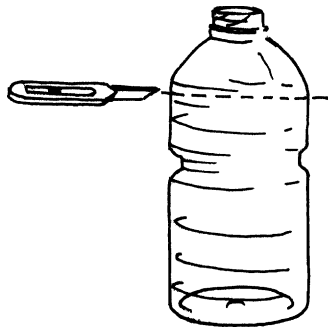

1. Take a 1-litre plastic water bottle. With a sharp knife cut its neck on the cylindrical part.



2. The top end will act like a funnel.

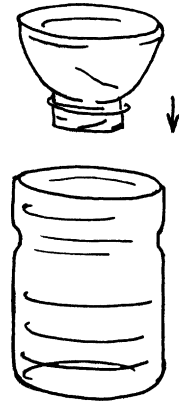

3. Invert the top to make a funnel.

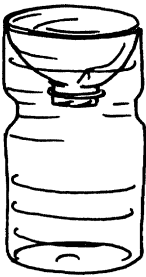

4. This funnel will prevent evaporation of water.



5. An empty plastic bottle being light will fall down or fly away in the slightest breeze. So dig a hole and bury the lower end of the bottle in the ground.

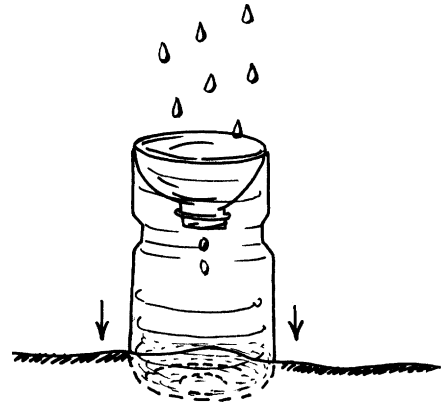

6. This foundation will anchor the bottle in place.

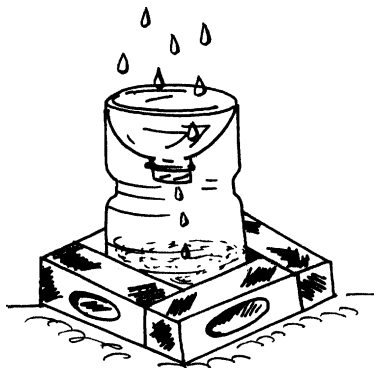
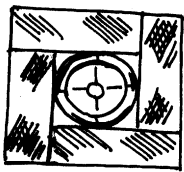

7. You can also place the bottle between four bricks as shown. This will keep the bottle in place and prevent it from toppling.

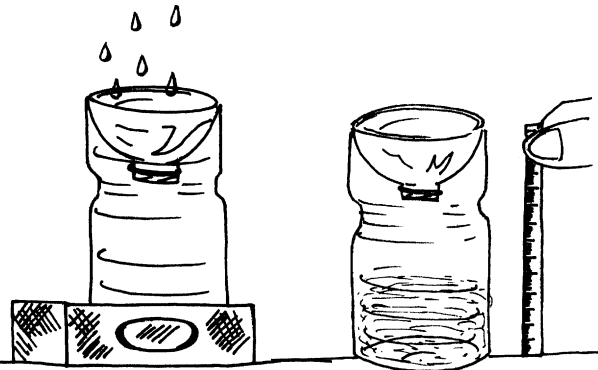

8. You can periodically measure the rainfall with the help of a scale.

## PRANK WITH A PLANK

How do you arrange three wooden planks to make a very strong beam?

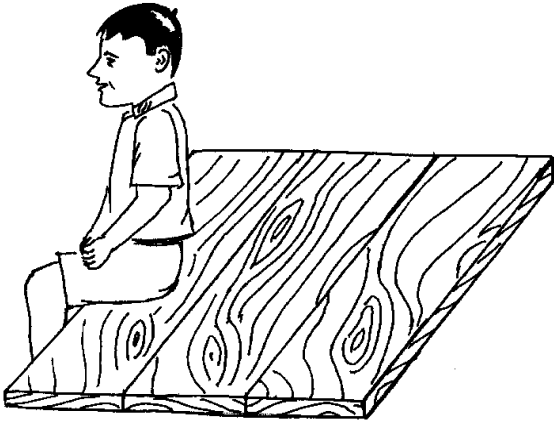

1. You could put all the three planks side by side, but that would be a pretty weak structure. The two planks on the right do not contribute to the strength of the structure.

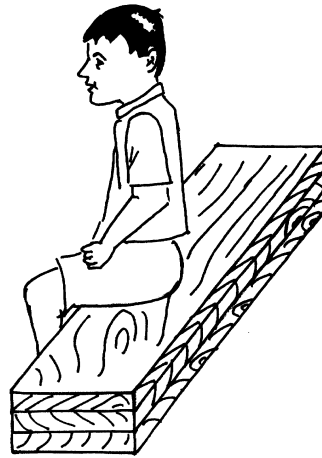

2. You could of course stack the three planks together one on top of the other and make one single plank three times the thickness of one plank. This would be stronger than the first arrangement.

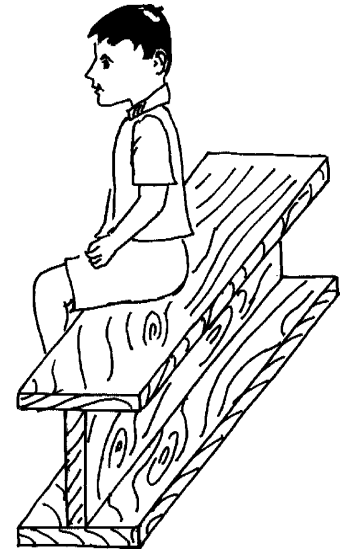

3. However, you could stand one plank vertically between two planks to make a beam the shape of an 'I'. This would be the strongest structure of them all.

## MATCHSTICK PICKING

Bet you can't pick up the last matchstick in this game?



This game is played by two. You need 20 matchsticks. Each player takes turns picking up one, two or three matchsticks. The one who picks up the last matchstick is the winner. You can ensure a win by insisting that your opponent go first. Now, if you can count to four, you are the winner.

This game is based on a simple mathematical calculation - multiples of four. The number of matchsticks you pick up depends on the number of matchsticks your opponent takes. The total of the combined moves must be four. (If your opponent takes three matchsticks, you take one. If two are removed, you pick two.) By going second you keep the number of remaining matchsticks divisible by four. On your opponents fifth turn, there will be four matchsticks remaining. Since three is the maximum number that can be picked up on a single move, you win!

## SMALL IS STRONG!

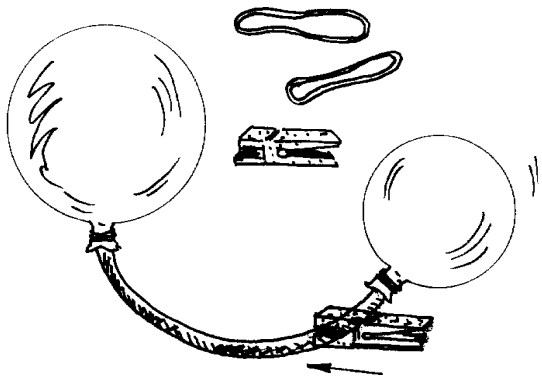

1. You will need two identical balloons, 10-cm length of plastic tubing and a clothespin. Fold the tube in half and pinch the halves together with the clothespin. Blow up one of the balloons so that it is almost fully inflated. Attach the neck to one end of the tubing with a rubber band (you may have to try a few times before you get an airtight connection). Inflate the second balloon slightly and attach it to other end of the tubing with the remaining rubber band. Open the clamp, allowing air to pass freely from one balloon to the other.

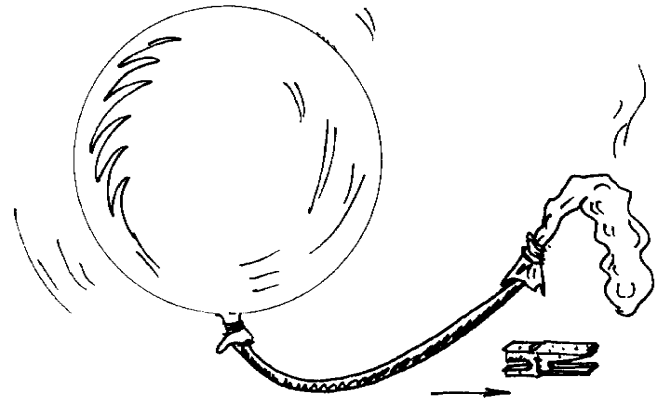

2. What do you expect would happen? Normally one would expect both the balloons to end up the same size. But something unexpected happens. The small balloon will always empty its contents into a large balloon.

The explanation is as follows. Fluids in a flexible container assume a shape that has the smallest surface area. A single large sphere has less surface area than two small spheres whose contents equal the single large one. Since one large balloon has less surface area than two balloons containing the same amount of air, the small balloon empties its contents into the larger one.

## FOLLOWING INSTRUCTIONS

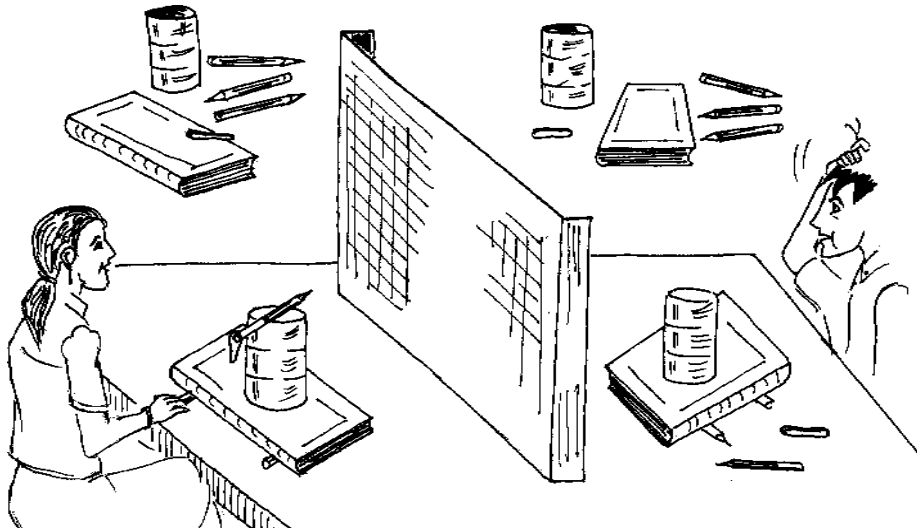

How good are we at giving and following precise and unambiguous instructions? This lovely activity tests this out. Two players sit across a table with a screen between them. Both are given the same set of objects - exactly the same. In the picture the girl puts these things one-by-one in a pattern. While arranging she also explains her actions in words to her partner. Her partner cannot see her arrangement but has to follow her instructions and make a similar arrangement. This is often not very easy. You will be absolutely surprised at the goof ups! This activity develops an ability to communicate precisely without mincing words. After finishing one round the partners reverse roles.

## TWO - IN - ONE

During the course of development several objects combined the use of two-in-one.  
These self-explanatory pictures show some real life examples.

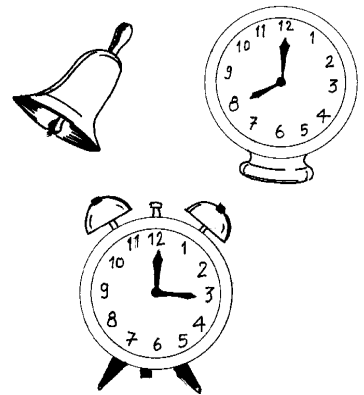
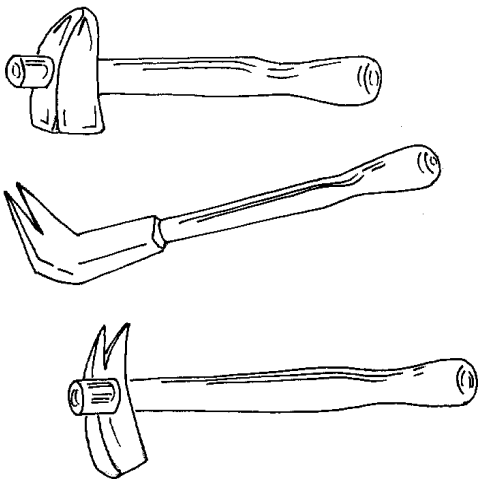
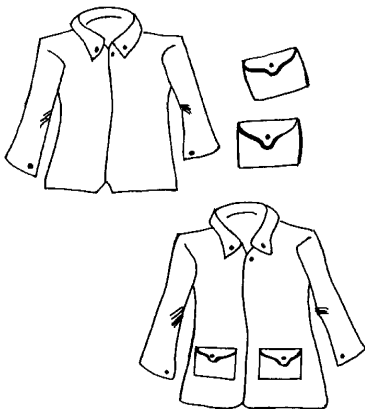
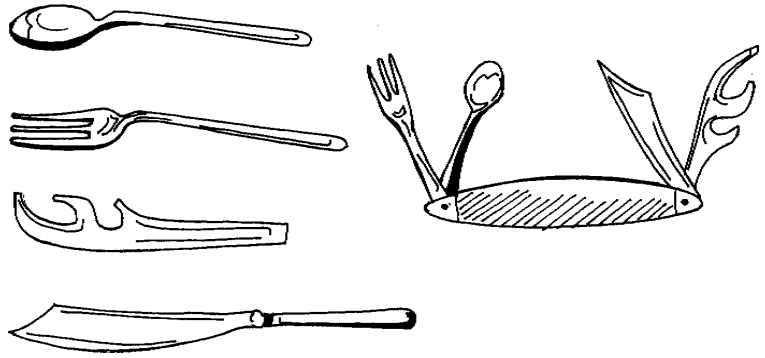
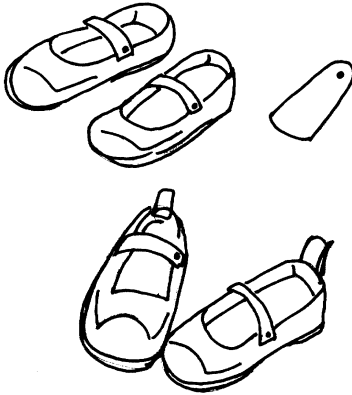
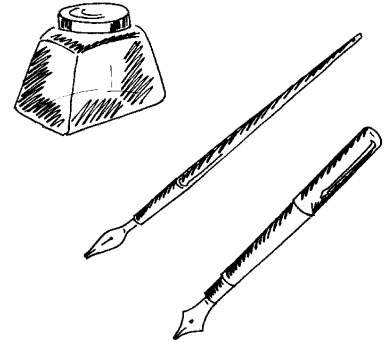
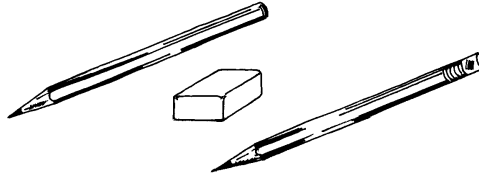
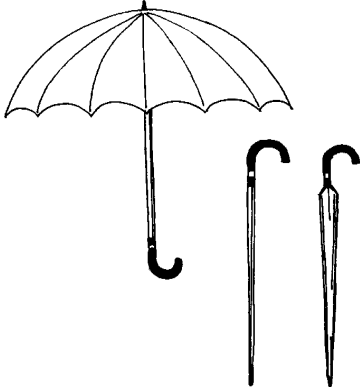



## A COLOURFUL SURPRISE

You need card sheet, an old transparency, glue, scissors and sketch pens to make this toy.  
As you pull the transparency the outlines of the fishes in the aquarium surprisingly become colourful!

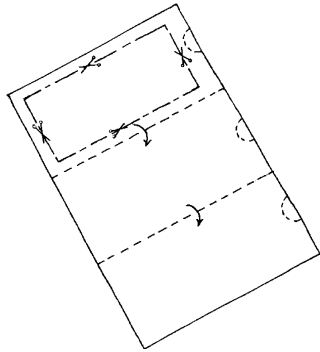

1. Take a card sheet 21-cm x 12-cm. Fold it into three. Cut out a window from the top rectangle. Cut semicircles on the right edge.

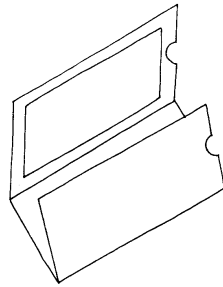

2. Fold the card sheet into such that the window comes on top. This is the folder.

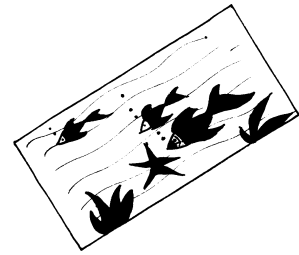

3. On a white card sheet 6.5-cm x 6-cm draw a picture of an aquarium with fishes swimming. Colour the fishes.

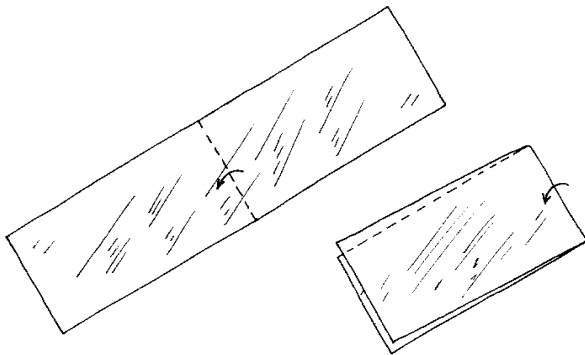

4. Cut a piece from an old transparency 6.5-cm x 12-cm. Fold it into half.

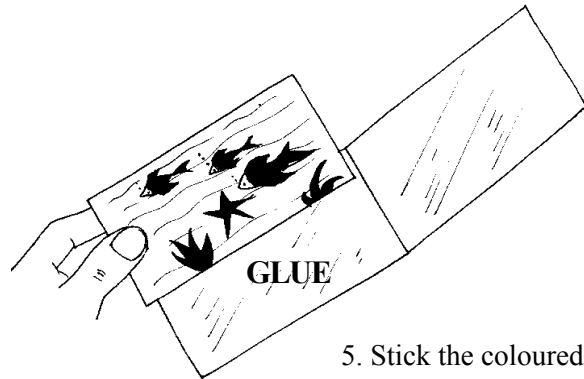

5. Stick the coloured card sheet on one half of the transparency as shown.

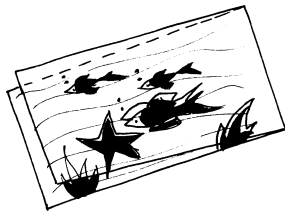

6. Fold the transparency in half. Now draw the outlines of the fishes etc. on the top transparency with a sketch pen.

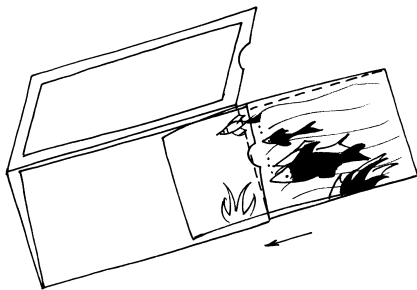

7. Slide the transparency in the folder. The colourful card sheet will be hidden. The transparency with the outline will be on top. Now close the folder window.

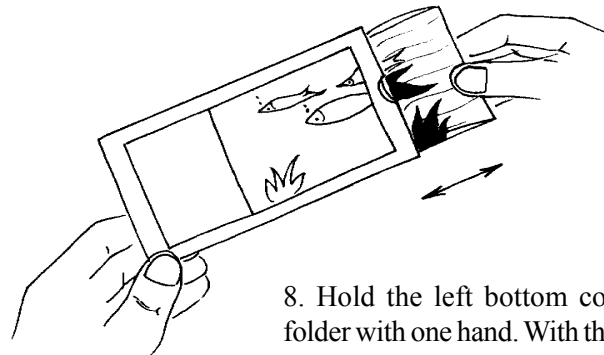

8. Hold the left bottom corner of the folder with one hand. With the right hand gently hold the fold of the transparency and pull it out. You will be surprised to find a colourful aquarium emerge out.

## POLISH PEDAGOGUE

CHILDREN ARE THE OLDEST PROLETARIAT OF THE WORLD!

Few people would have ever heard of Janusz Korczak, a Polish-Jewish children's writer and educator. He was a trained medical doctor who specialized in children's diseases. He founded the first national children's newspaper, trained teachers and worked in juvenile courts defending children's rights. His books *How to Love a Child* and *The Child's Right to Respect* gave parents and teachers new insights into child psychology. Generations of young people had grown up on his books, especially the classic *King Matt the First*, which tells of the adventures and tribulations of a boy king who aspires to bring reforms to his subjects. He set up orphanages in the dark slums of Warsaw and lived among children in real life, not just in the imagination, for he saw them as the salvation of the world.

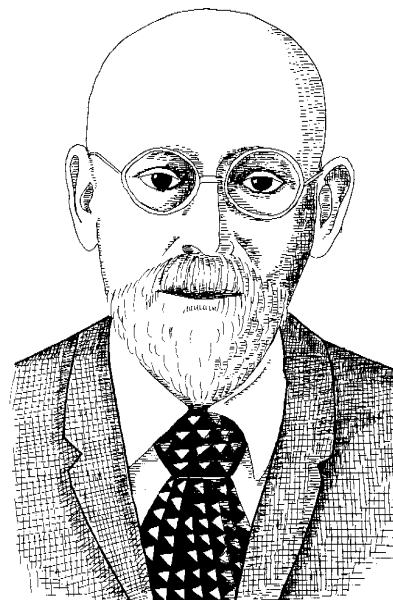

Janusz Korczak was born Henryk Goldszmit – a Polish Jew. But he would be by his pseudonym Janusz Korczak that he would be remembered. Korczak felt that within each child there burned a moral spark that could vanquish the darkness at the core of human nature. To prevent that spark from being extinguished, one had to love and nurture the young, make it possible for them to believe in truth and justice. The titles of his books are suggestive of his innate sensitivity – *Confessions of a Butterfly*.

Because Korczak was determined to live both as a Pole and a Jew in pre-war Poland, he was not above criticism. Jews saw him as a renegade who wrote in Polish rather than Yiddish or Hebrew. The right-wing Poles never forgot that he was a Jew. The radical socialists and the communists of the interwar period saw him as a conservative because he was not politically active, and the conservatives saw him as a radical because of his socialist sympathies.

The children in the orphanage often performed the famous play *The Post Office* written by Tagore.

Korczak loved children deeply; he devoted all the moments of his life to them. He studied them and understood them more thoroughly than most. Since he knew children, he did not idealize them. As there are good and bad adults, all kinds and sorts, so too Korczak knew there are all kinds of children. Korczak saw children for what they were, and was at all times deeply convinced of their integrity. He suffered from the fact that often children were treated badly, not given the credit they deserved for their intelligence and basic honesty.

On August 6, 1942 the Nazis ordered the two hundred children of the orphanage to be taken to the train station, to be packed into railroad carriages. Korczak, knew that the carriages were to take the children to their death in the gas chambers of Treblinka.

To assuage the children's anxiety, Korczak told them that they were all going for an outing in the country. On the appointed day the oldest child led them. As always, even in this terrible situation, Korczak had arranged things so that a child rather than an adult would be the leader of other children. He walked immediately behind this leader, holding the hands of the two smallest children.

Korczak sacrificed himself to keep his trust with the children, when he could have easily saved himself. With his many friends in high places it was very easy for him to escape. But as the head and leading light for thirty years of the Jewish orphanage in Warsaw, Korczak was determined not to desert any of the children who had put their trust in him. As he said to those who beseeched him to save himself: "One does not leave a sick child in the night," and "One does not leave children in a time like this."

The children remained calm throughout, as if in silent protest, or contempt of the murderers. One of the German guards told Korczak to leave. But Korczak refused, as before, to separate himself from the children, and went with them to the gas chamber in Treblinka.

*(Janusz Korczak's biography KING OF CHILDREN by Betty Jean Lifton can be downloaded from <http://arvindguptatoys.com>)*

## CAN YOU PICK THE HANDKERCHIEF?

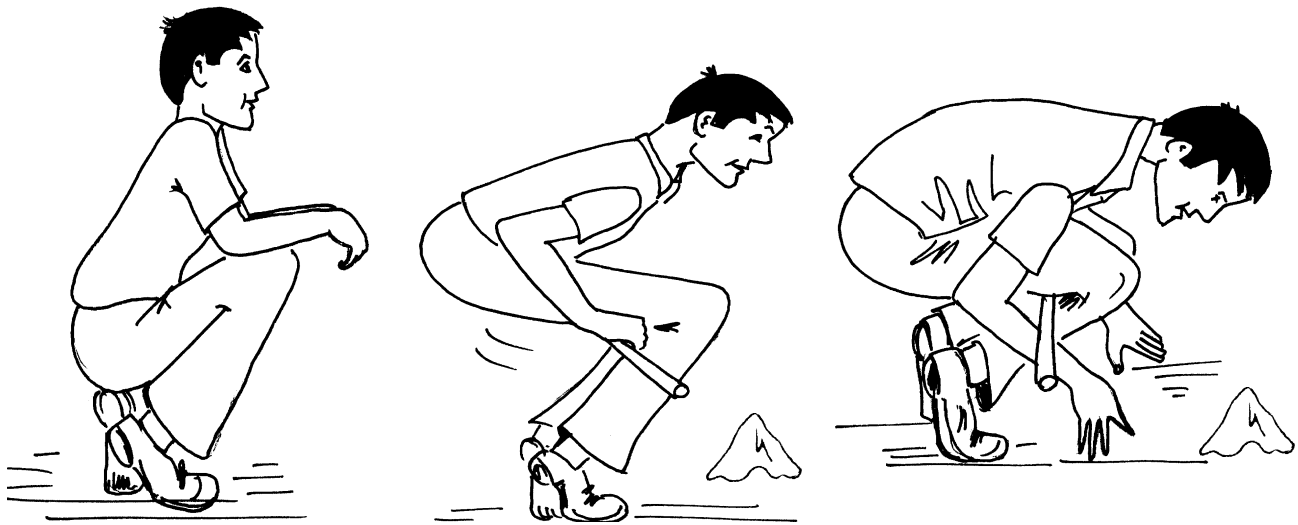

Try to sit on your heels. Place a bamboo stick under your bent knees and crook your elbows around it. Now put a handkerchief on the ground in front of you. Lean forwards using your hands for balance, and try to pick up the handkerchief with your teeth.

As you rotate forwards towards the handkerchief, the centre of gravity is shifted away from the stable position directly above your feet. Once it goes too far, you become unstable and fall on your nose.

## MATCHLESS MATCHSTICK

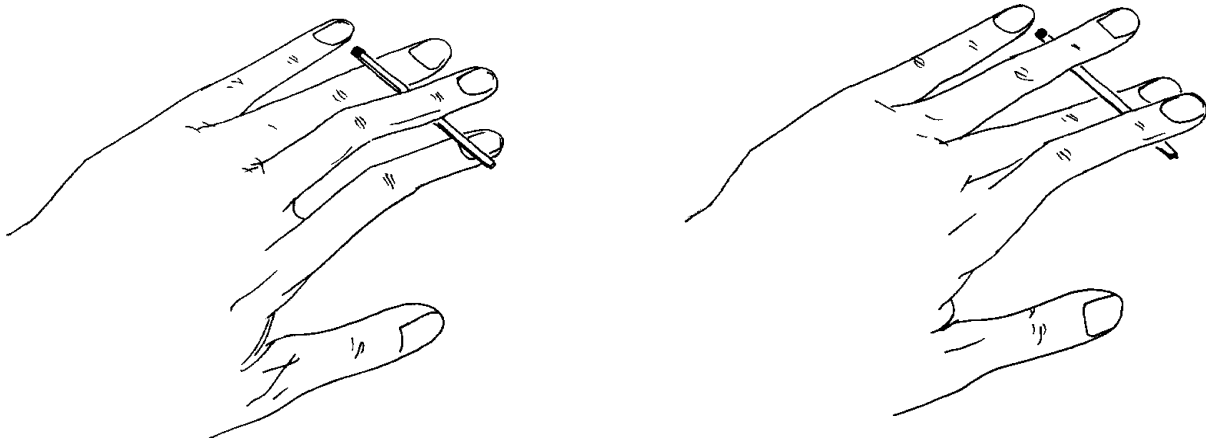

Place a wooden match across the back of your middle finger and under the first and third fingers at the joints nearest the fingertips. Try to break the match by pressing up with the middle finger and down with the other two. Don't let the thumb and little finger help out. That's considered cheating.

This is an impossible situation because you are not using your fingers to gain a mechanical advantage. Your fingers can be used as levers, which are devices that can increase a force when used properly. The key to a lever is the location of the fulcrum, and the force being delivered to it. In this trick, the fulcrum is the set of knuckles where your fingers attach to your hand. When you try to deliver a force far from this point of attachment, your muscles are too weak to do the job.

If however, you move the match to the other side of the middle joints close to the knuckles you will be able to break it easily. Now your lever fingers can supply enough power.

## SOAP BUBBLES

Making soap bubbles is fun.

While playing with them you can also learn some basic principles of science.

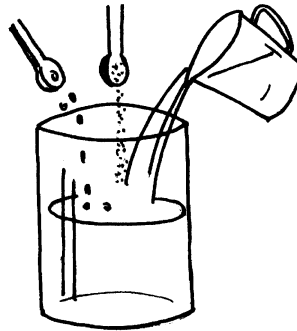

Glycerine

Water

1. Mix bits of scraped soap, detergent, liquid soap and water in a glass. Add a spoon of glycerine. Try and experiment to get the right mix.

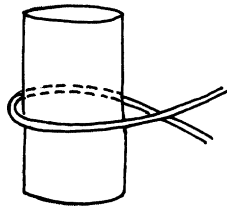

2. Wrap a piece of thin wire on a cylindrical object.

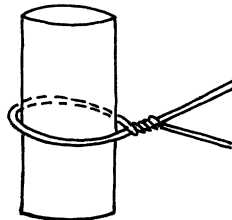

3. Twist the ends of the wire to make a handle.

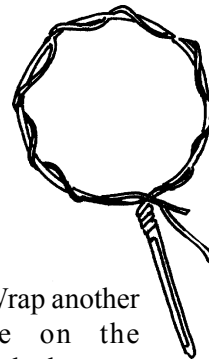

4. Wrap another wire on the circular hoop.

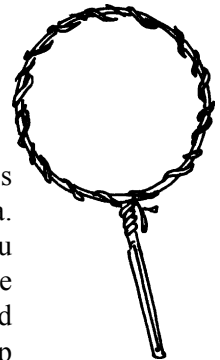

5. This increases the surface area. This enables you to pick up more soap solution and make bigger soap bubbles.



6. Bend the handle upwards at an angle of 45-degrees.



7. Dip it in soap solution.

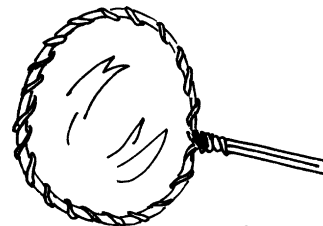

8. You will see a soap film on the hoop.

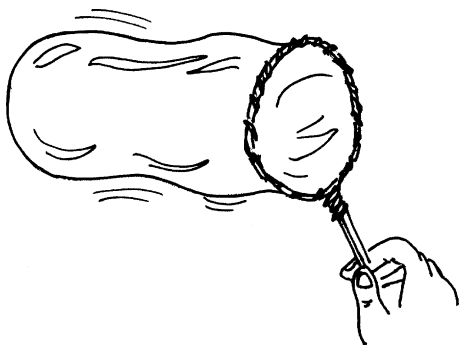

9. Now move your hand briskly to produce an elongated soap bubble.

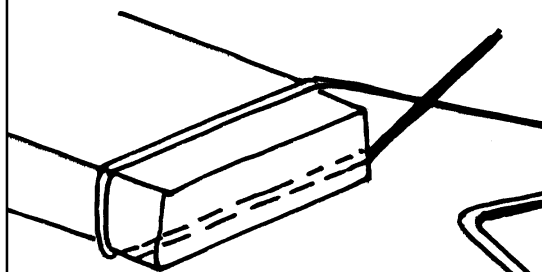

10. Twist the wire on a rectangular piece of wood.

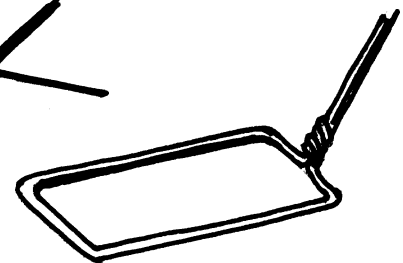

11. To make a rectangular soap bubble blower.

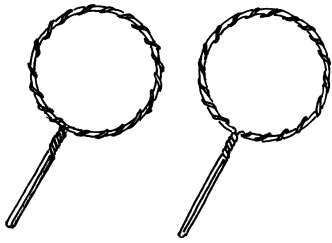

12. Make two circular bubble blowers.



13. Dip them in soap solution and bring them close.

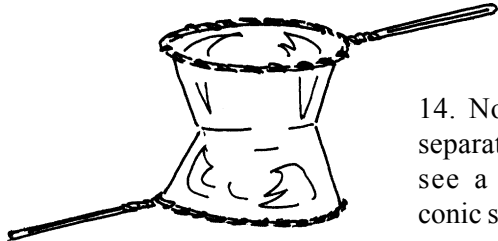

14. Now slowly separate them to see a beautiful conic section.

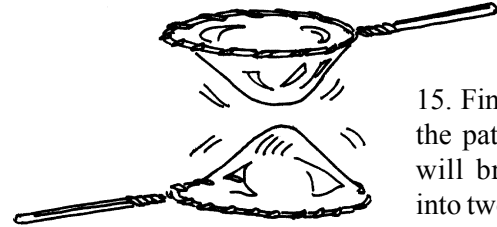

15. Finally the pattern will break into two.

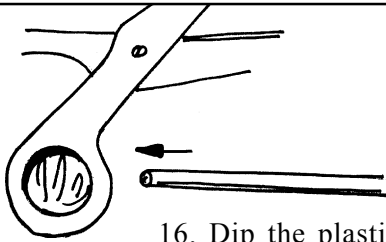

16. Dip the plastic handle of a scissors in soap solution.

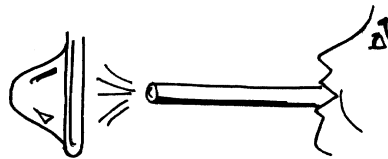

17. Blow with a plastic straw.

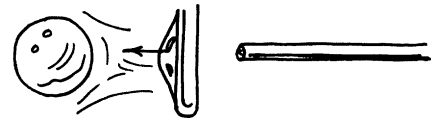

18. To produce a perfect soap bubble.

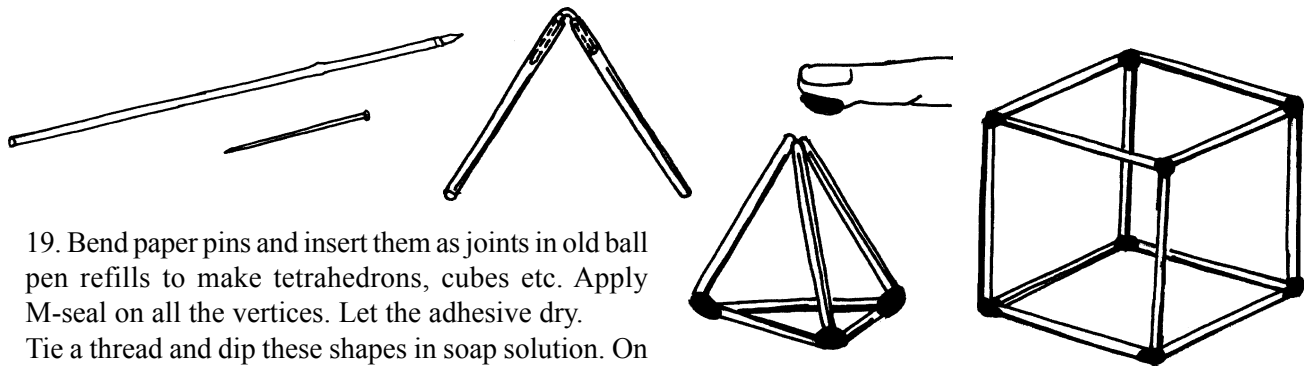

19. Bend paper pins and insert them as joints in old ball pen refills to make tetrahedrons, cubes etc. Apply M-seal on all the vertices. Let the adhesive dry. Tie a thread and dip these shapes in soap solution. On lifting you will see an amazing pattern of soap films.

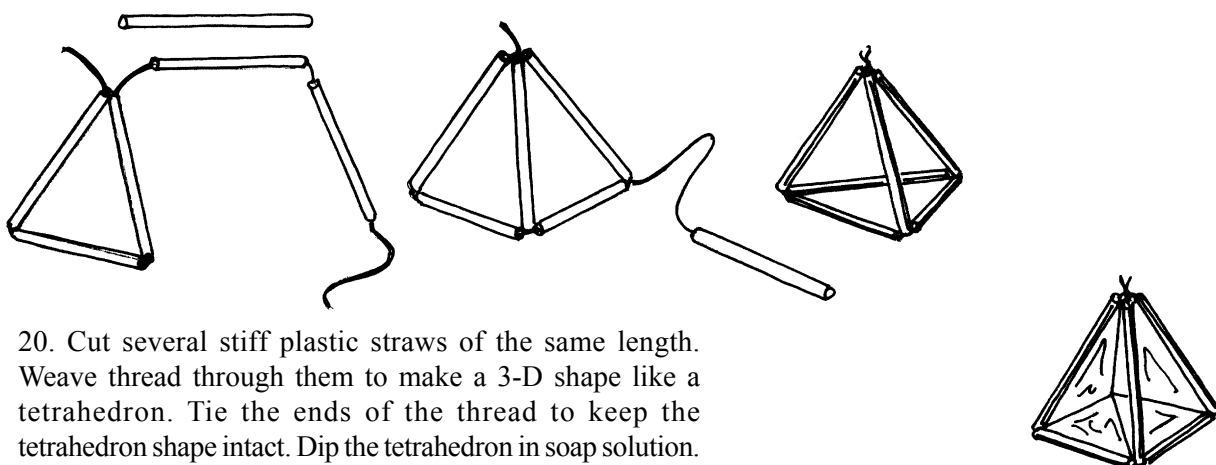

20. Cut several stiff plastic straws of the same length. Weave thread through them to make a 3-D shape like a tetrahedron. Tie the ends of the thread to keep the tetrahedron shape intact. Dip the tetrahedron in soap solution. Then remove it to see a wonderful soap film pattern.

## LARGE SOAP FILMS

Adding glycerine to the soap solution makes the film more elastic. The films last longer and look shiny.

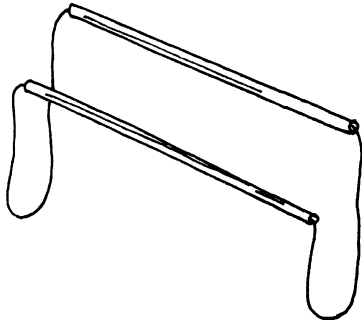

1. Take two long straws and string. Thread 90-cm of string through two plastic straws. Knot the strings.

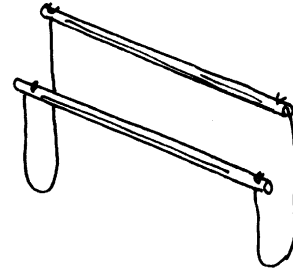

2. Make holes with needles on the ends of the straws and attach the threads as shown.



3. To make long lasting films add a few spoons of glycerine to the soap solution. Drop the straw-thread frame into the soap solution.



4. Holding the straws, gather a film across the strings. Pull the straws apart to stretch the film open. Pull upwards, gently filling the film with air. With a small jerk, snap the bubble free of the frame. You will be delighted to see large, glistening soap bubbles floating in the air.

# CLIMBING MAN

You need a long strip of paper to fold this delightful toy.  
This works best with paper which is a bit rough. Brown paper is ideal.

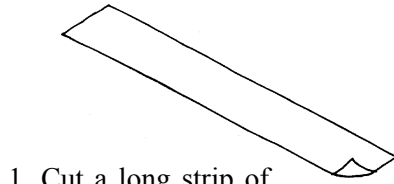

1. Cut a long strip of paper 30-cm x 8-cm.

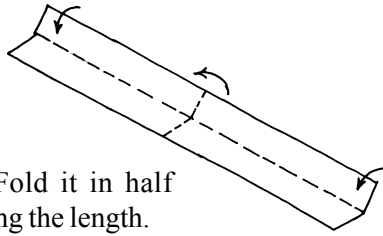

2. Fold it in half along the length.

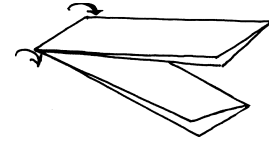

3. Fold it into a quarter as shown.

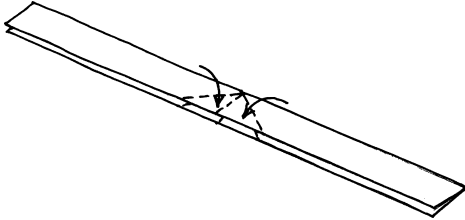

4. Open the strip and fold 45-degree corners at the centre.

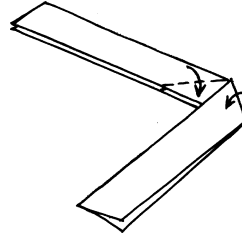

5. Here are the details of the 45-degree corners.

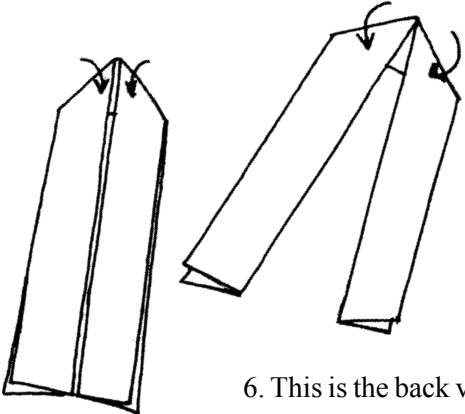

6. This is the back view.

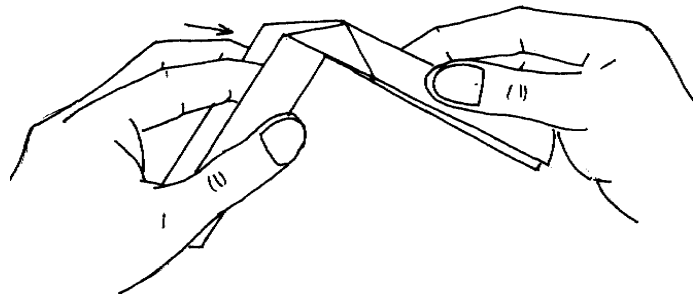

7. Now lift the left end at right angles. Squash it with your index finger in the middle. The lifting and squashing of the left end is shown here.

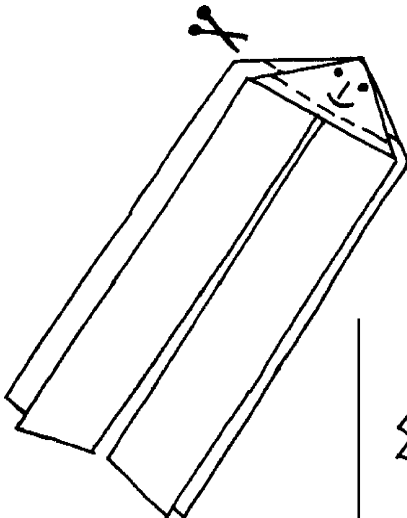

8. There would be two channels with a triangular head. Draw a face on the triangle and cut it on the dotted line.

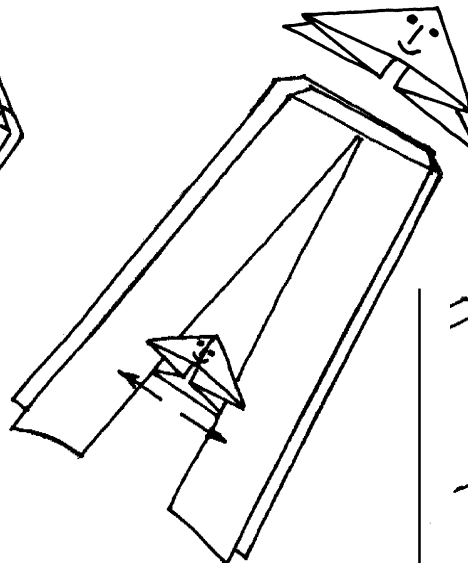

9. Insert the triangular face between the channels.

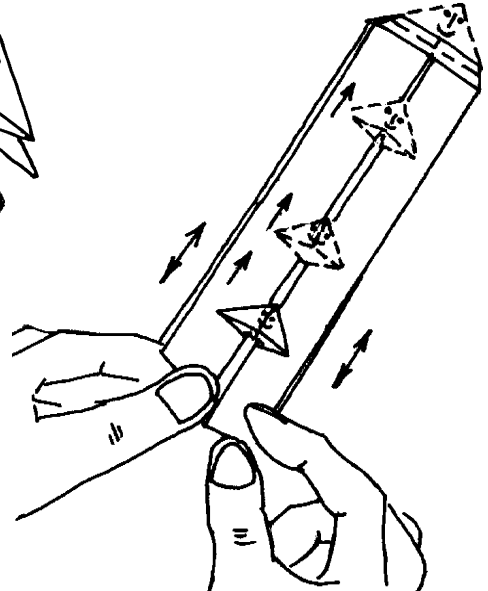

10. On alternately pushing and pulling the two ends of the channel the triangular face will climb up and will be ejected from the top.

## BRAILLE CUBE

Visually impaired people can learn the Braille language with this wonderful cube.

It is being manufactured by a charity *Vidya Vrikshah* based in Chennai and sold for just two rupees!

1. The device is similar to a Rubik's cube, but has different patterns of raised dots on its sides corresponding to the Braille representation of letters in any language. The raised dots appear in one or more of the six positions arranged in three columns of two rows on each side of the cube.

The cube consists of three segments which can be rotated about a common axis. Thus different dot patterns corresponding to different letters can be formed on its sides.

Thus each letter of the alphabet of any Indian language (or for matter any world language) can thus be represented on any one side of the cube.

The dot positions are numbered 1 to 6 and different patterns of dots on the cube and the letters to which they correspond are as seen in the pictures below.

With six dot positions, Braille admits of a maximum of 63 dot patterns, more than enough to represent for representing all the letters of any alphabet. All these can be formed on any side of the cube. With a ready chart containing the letters (and their dot patterns) any person can learn the use of the cube within an hour.

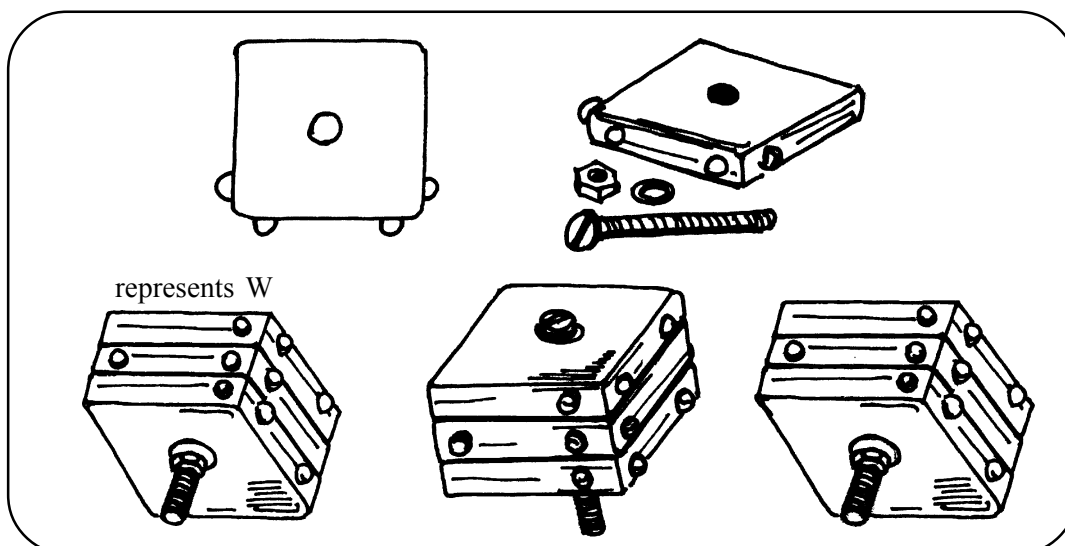

•   •   ••   ••   •   ••   ••   ••   •   ••   ••	•   •   ••   ••   •   ••   ••   ••   •   ••   ••	••   ••   ••   ••   ••   ••   ••   ••   ••   ••	••   ••   ••   ••   ••   ••   ••   ••   ••   ••	••   ••   ••   ••   ••   ••   ••   ••   ••   ••	••   ••   ••   ••   ••   ••   ••   ••   ••   ••	••   ••   ••   ••   ••   ••   ••   ••   ••   ••	••   ••   ••   ••   ••   ••   ••   ••   ••   ••	••   ••   ••   ••   ••   ••   ••   ••   ••   ••	••   ••   ••   ••   ••   ••   ••   ••   ••   ••
<b>a</b>	<b>b</b>	<b>c</b>	<b>d</b>	<b>e</b>	<b>f</b>	<b>g</b>	<b>h</b>	<b>i</b>	<b>j</b>
•   •   ••   ••   •   ••   ••   ••   •   ••   ••	•   •   ••   ••   •   ••   ••   ••   •   ••   ••	••   ••   ••   ••   ••   ••   ••   ••   ••   ••	••   ••   ••   ••   ••   ••   ••   ••   ••   ••	••   ••   ••   ••   ••   ••   ••   ••   ••   ••	••   ••   ••   ••   ••   ••   ••   ••   ••   ••	••   ••   ••   ••   ••   ••   ••   ••   ••   ••	••   ••   ••   ••   ••   ••   ••   ••   ••   ••	••   ••   ••   ••   ••   ••   ••   ••   ••   ••	••   ••   ••   ••   ••   ••   ••   ••   ••   ••
<b>k</b>	<b>l</b>	<b>m</b>	<b>n</b>	<b>o</b>	<b>p</b>	<b>q</b>	<b>r</b>	<b>s</b>	<b>t</b>
•   •   ••   ••   •   ••   ••   ••   •   ••   ••	•   •   ••   ••   •   ••   ••   ••   •   ••   ••	••   ••   ••   ••   ••   ••   ••   ••   ••   ••	••   ••   ••   ••   ••   ••   ••   ••   ••   ••	••   ••   ••   ••   ••   ••   ••   ••   ••   ••	••   ••   ••   ••   ••   ••   ••   ••   ••   ••	••   ••   ••   ••   ••   ••   ••   ••   ••   ••	••   ••   ••   ••   ••   ••   ••   ••   ••   ••	••   ••   ••   ••   ••   ••   ••   ••   ••   ••	••   ••   ••   ••   ••   ••   ••   ••   ••   ••
<b>u</b>	<b>v</b>	<b>w</b>	<b>x</b>	<b>y</b>	<b>z</b>				

More details can be found at: <http://www.vidyavrikshah.org>



## RUBBER STAMPS

Simple rubber stamps can be made using pieces of old cycle tube, blocks of wood and glue. Children can make lovely collages using these zero-cost rubber stamps.

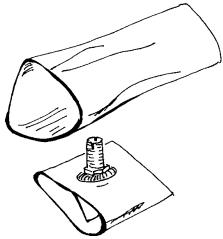

1. Take a piece of old cycle rubber tube.

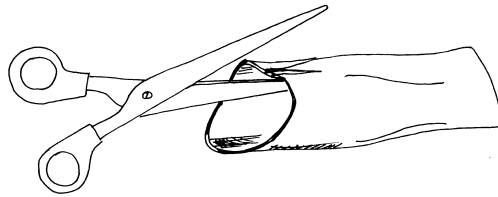

2. Cut it along the length.

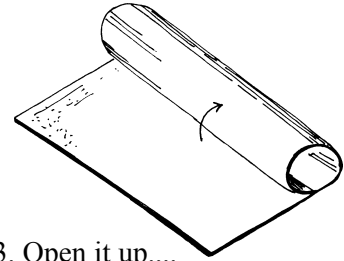

3. Open it up....

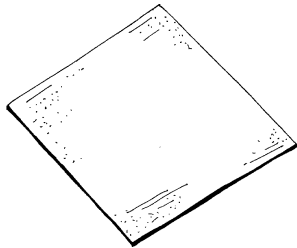

4. ....to make a flat rubber sheet.

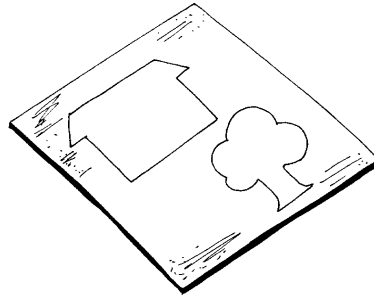

5. Draw a picture of a tree and a house on it.

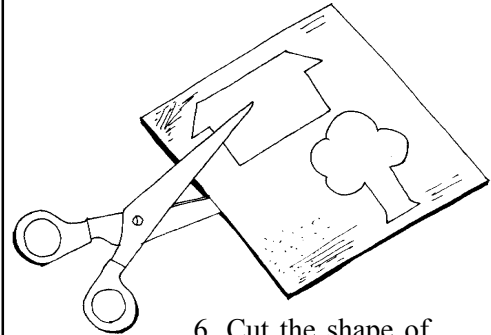

6. Cut the shape of the house and tree.

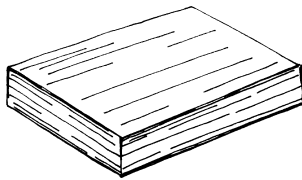

7. Take a block of flat wood.

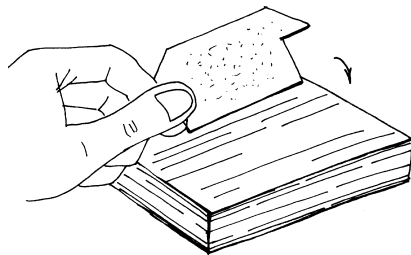

8. Stick the rubber house cutout on the block using rubber adhesive (Cycle puncture solution or *Fevibond*).

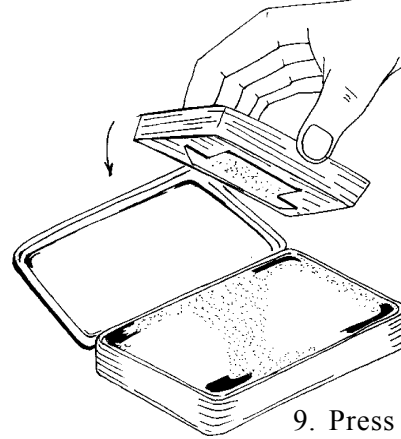

9. Press the rubber stamp on the ink pad.

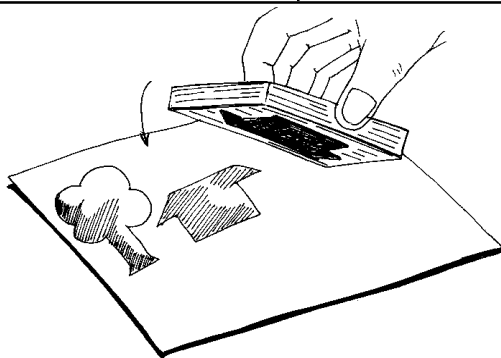

11. Print these shapes on a sheet of paper.

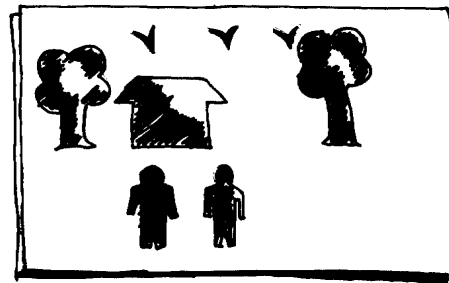

12. Children can make lovely pictures using these zero-cost rubber stamps.

# FLAT FLEXAGON

You don't need any special tools to make this magical flexagon.  
All you need is some bond paper, scissors and glue.

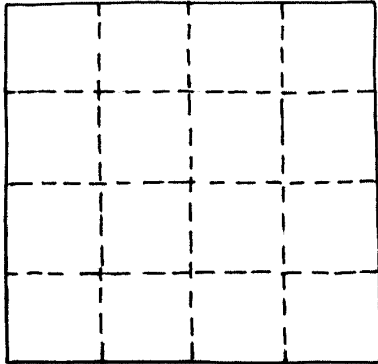

1. Take a 10-cm x 10-cm square of bond paper. Fold it into 16 small squares.

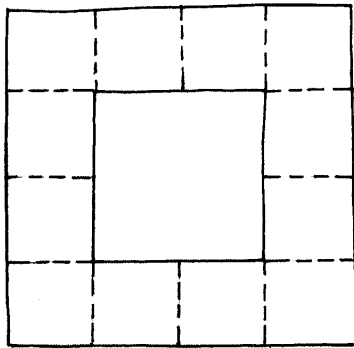

2. Cut the middle 4 squares to make a central window.

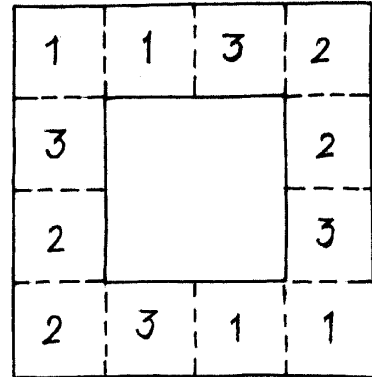

3. Number the twelve squares as shown. There will be four 1's, 2's and 3's.

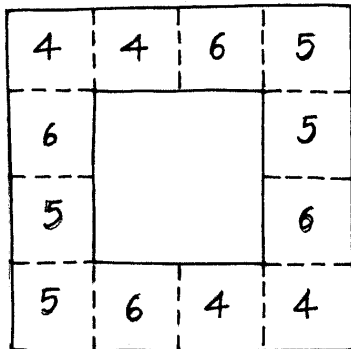

4. Now upturn the paper. Number the reverse squares as shown. There will be four 4's, 5's and 6's.

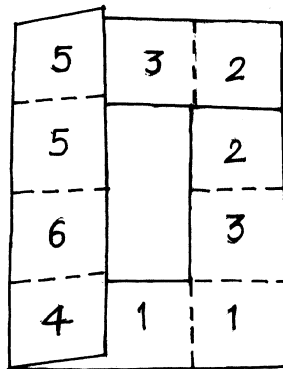

5. Fold the left vertical strip inwards to the right.

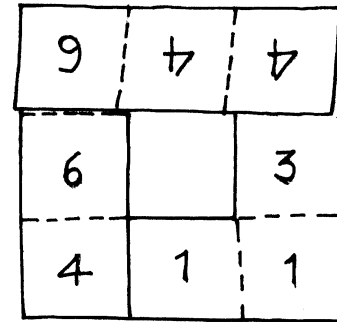

6. Fold the top strip inwards towards the bottom.

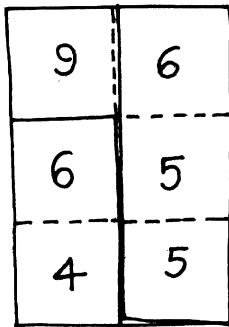

7. Fold the right vertical strip to the left.

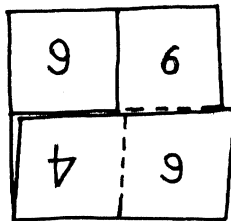

8. Finally fold the bottom strip to the top. The square has three 6's but one odd number 4.

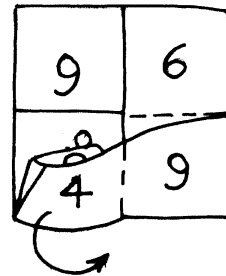

9. We want all the numbers to be the same - namely 6. For this lift the corner with number 4.

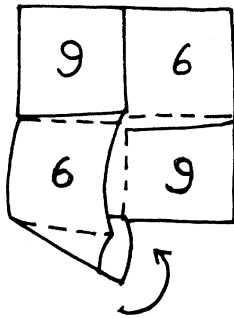

10. Bring the flap to the centre, locking the flexagon in the process. Now all the four small squares will have the number 6 on them.

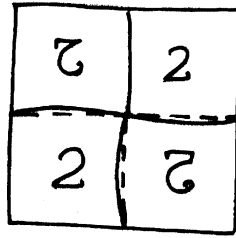

11. This lock is very crucial so practice it a few times.

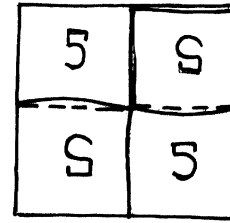

12. This flexagon can be endlessly rotated / flexed to get faces with 1, 2, 3, 4, 5 and 6 (not necessarily in the same order) written on them.

13. You can draw different pictures on this flexagon and use it to depict a cycle or a sequence.

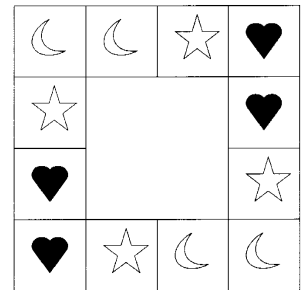
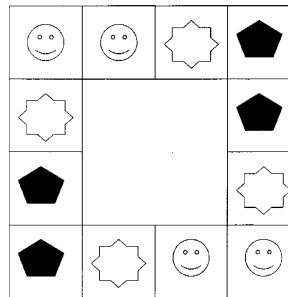
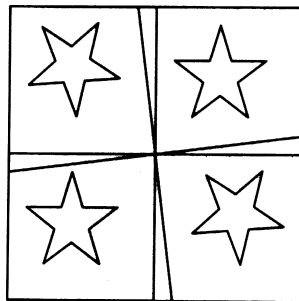
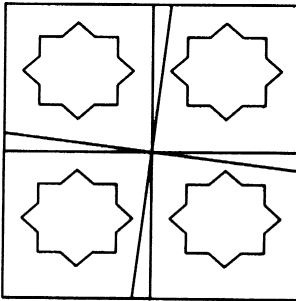

## STREAMLINING

Streamlining reduces the amount of resistance experienced by an airfoil.

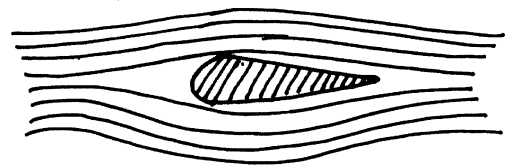
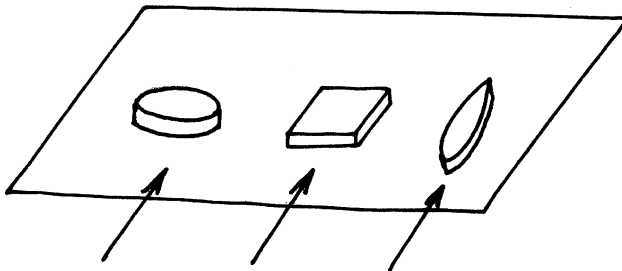

Streamlining is the shaping of an object, such as an aircraft body or wing, to reduce the amount of drag or resistance to motion through a stream of air. A curved shape allows air to flow smoothly around it. A flat shape fights air flow and causes more drag or resistance. Streamlining reduces the amount of resistance and increases lift.

To produce less resistance, the front of the object should be well rounded and the body should gradually curve back from the midsection to a tapered rear section.

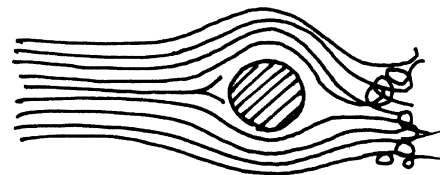

## LIGHT THE LAMP WITHIN, TEACHER

Inclusion is important. Without inclusion, I will not be able to know that boundaries are meant to be pushed... not be lived in. Take for example the fact that I clean my house but empty my garbage on the road. That is because the road is not "included" in what I deem to be my own. I feed my own child but do not enquire if the maid has eaten today. This is because her hunger is not included in my hunger.

Teach me to communicate with the simplicity of the child and the nakedness of a flower. Teach me to communicate with people less gifted, less privileged than I am.

I pray to you to teach me to understand the nature of things. Teacher, teach me "to make sense" in an increasingly senseless world so that I am able to understand things around me without the intermediation of soothsayers and spiritual Gurus. In moments of crisis, teach me such that I am able to come to my own conclusions.

As you teach me to deal with moments of crisis - teach me how to come out of them without residual toxicity. For there will be moments in life when I will see cracks in the walls of those who had taught me the meaning of strength and solidity. In those difficult moments, I should not become cynical.

Help me to learn newer ways to learn. And that will make learning a joy for me.

I pray to you to teach me to learn from unusual sources. As people come and touch my lives, as they do small things for me, teach me how I can learn from them - things that no classroom will ever teach. Teach me to learn my sense of duty from the driver of the school van who must rise before I do. Teach me to learn compassion from the Sisters of Charity in whose fragile arms - even death can sleep like a baby. Teach me to learn contentment from the traffic policeman who is paid to inhale carbon monoxide for the 76,800 hours of his life that he has to stand in the middle of the road. Teach me to learn to work unsupervised like the ant and the bee who do not need anyone to breathe down their neck so they add value each new day as they wake up to work.

I pray that you teach me to appreciate the inter-connected nature of things. Teach me to appreciate that the trees I fell, the small creatures I kill with indiscriminate use of fertilisers and pesticides on the ground, the urban decay I cause with my consumptive ways all cause awesome imbalances, in the natural state of things that cause death and destruction and can one day, engulf me. Teacher, tell me why the singing birds are going away. And tell me how I can see them again perched on my window sill.

I pray to you to teach me not just the ability to answer, but also the power to question. It is because everyone is telling me to do as told. Before I know, I might become enslaved in a social, economic and political state in which progress is held hostage because we do not ask questions.

Only if we ask questions, we can get answers. If we get the answers, we can explore how to establish a higher order of things. If we ask the questions, we will also learn to be accountable. We will be more willing to accept that when we ask the questions, we can be questioned too. In that mutuality, trust will emerge and balance itself.

I also pray to you to teach me to say "I do not know." In all humility, I must admit Teacher, that not always will I have all the answers. When I do not have the answer, teach me to say, "I do not know." I know it takes courage and self-confidence to say that I do not know. So often I see people keep silent when admission of ignorance could have opened them to new relationships and new knowledge. Teach me the power to say, "I do not know."

Just as you teach me to say, "I do not know." I pray to you to teach me to actively seek help.

Higher my achievements and greater my position of power, the more helpless I will become; the less I will know about the state of things. In those moments of my helplessness, my ego will come in my way of seeking help. My workplace will make me feel falsely that seeking help is a sign of weakness.

Teach me to seek help from small people. Teacher, teach me that flower needs help from the bee to pollinate. The water needs help from the air to raise itself to the sky.

O' Teacher, please teach me such that I understand that even the lord of the universe can do with a little help from me. Hence, I have no shame in seeking help from others.

*From: Subroto Bagchi's Convocation Address*

## FLOATING BALL

You need a flexi-straw, a film can, a thermocole ball and simple tools to make this toy.  
As you blow on one end of the straw the ball surprisingly lifts and floats in the air.

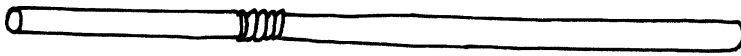

1. Take a plastic straw with accordion pleats. Such a straw can bend at right angles.

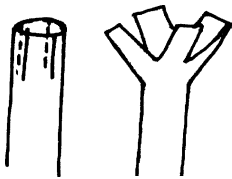

2. Make 4 symmetric vertical cuts (1-cm deep) and flair the petals to make a carriage.

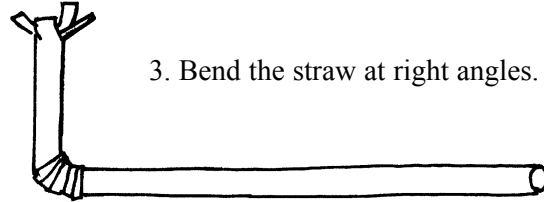

3. Bend the straw at right angles.

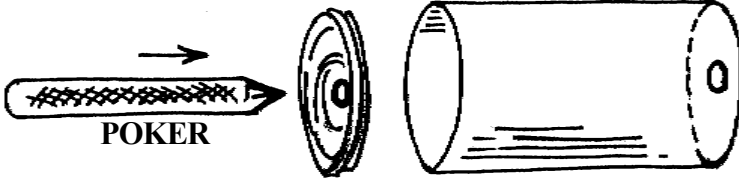

4. Make holes in the centre of the base and lid of a film can. The hole should be just big enough for the plastic straw to press fit.

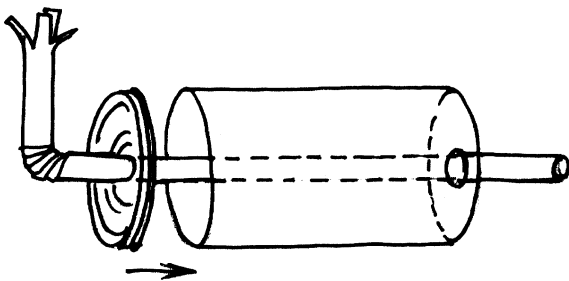

5. Insert the plastic straw in the film can.

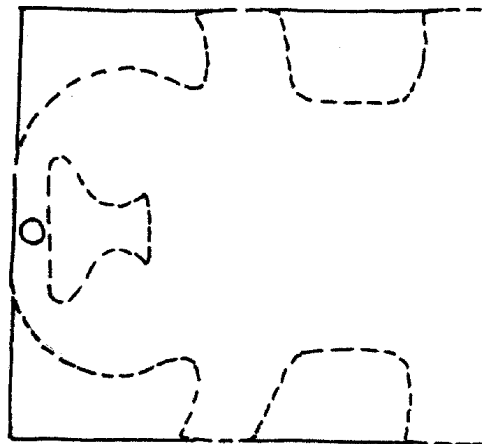

6. Draw this picture on a thin card sheet. Cut along the dotted lines.



7. Take double pieces of card sheet. Cut the ears and eyes of the elephant and stick them in place.



8. Place a thermocole ball or a pea seed in the carriage of the plastic straw and blow from the other end. The ball will surprisingly lift and float in the air.

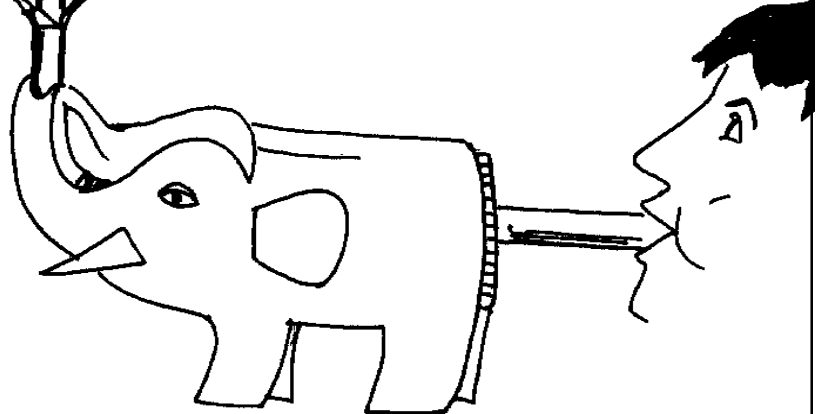

## PAPER POP-UP

These double slit pop-ups offer a lot of possibilities.  
Many more forms are possible with this configuration.

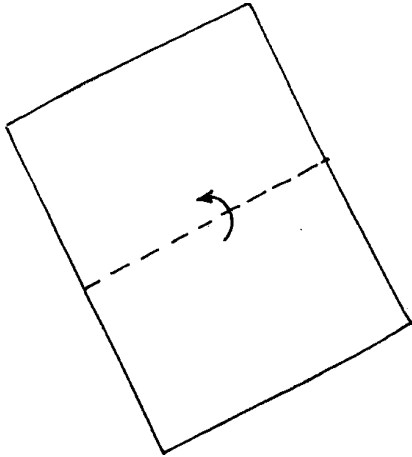

1. Fold a sheet of stiff paper in half.

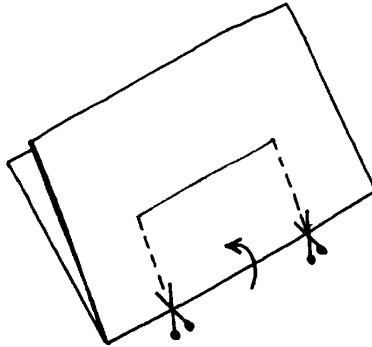

2. Draw two lines from the fold to the centre of the paper and then join them. Cut along the two dotted lines.

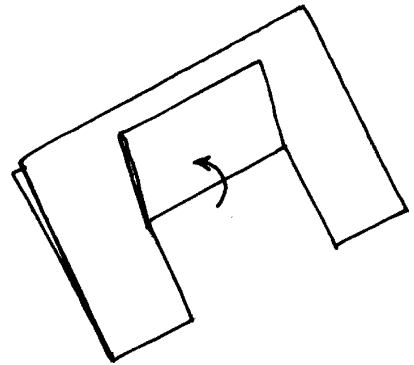

3. Carefully, make a crease between the two slits, folding the paper upwards.

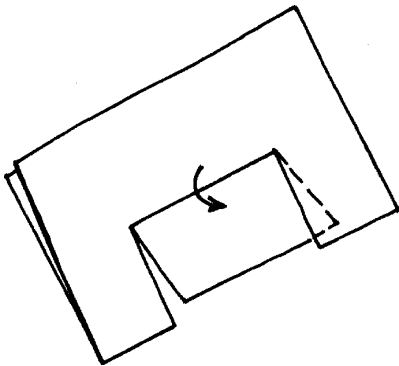

4. Then fold the flap backwards along the same crease line.

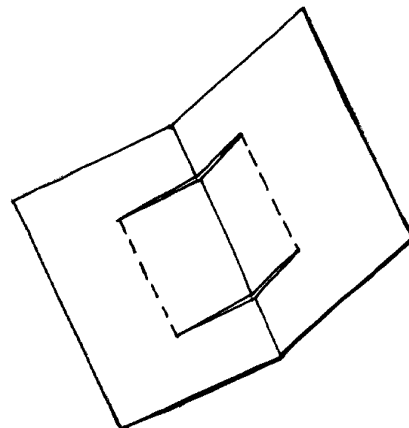

5. Unfold the flap back to its previous position, then open out the card.

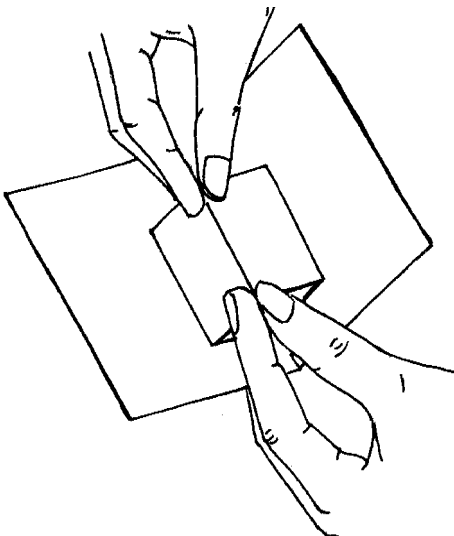

6. To form a pop-up. Pull up the central portion of the gutter crease to create a mountain. All the other creases remain as valleys. Close the pop-up shut and press it flat to strengthen all the creases.

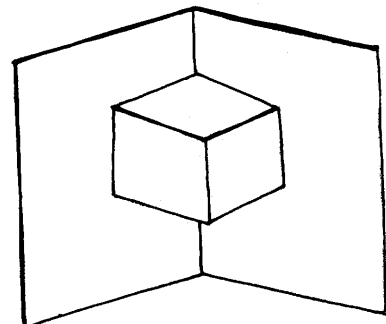

7. This pop-up is made with two slits.

## MULTI-STEP POP-UP

A pop-up, in a pop-up in a pop-up.  
This three-in-one pop-up makes a very pretty step ladder.

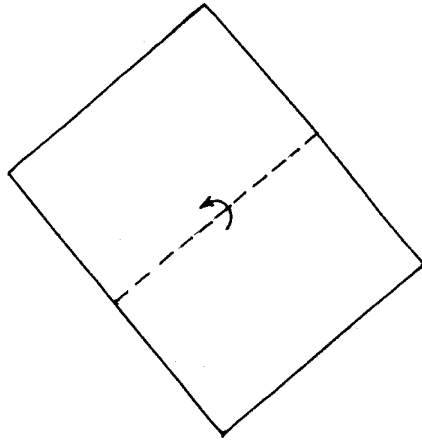

1. Fold a sheet of stiff paper into half.

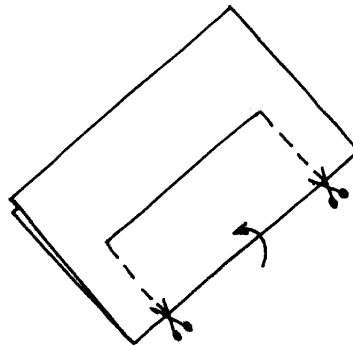

2. Draw two lines perpendicular to the fold crease and join them. Cut along the dotted lines.

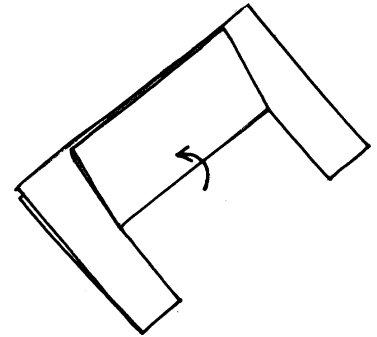

3. Fold a crease between the ends of the slits. Fold the paper forwards and backwards along the same line.

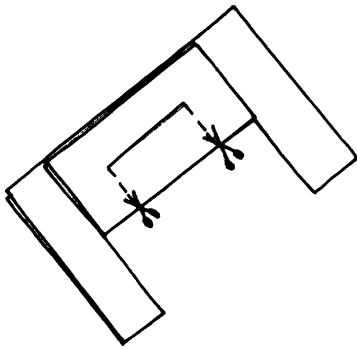

4. Finally close the pop-up and make two more slits. Fold a crease between the ends of the slits.

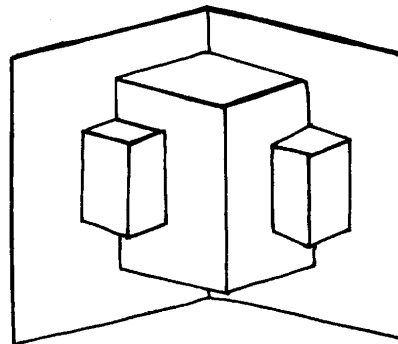

5. At this stage the pop-up will look like this.

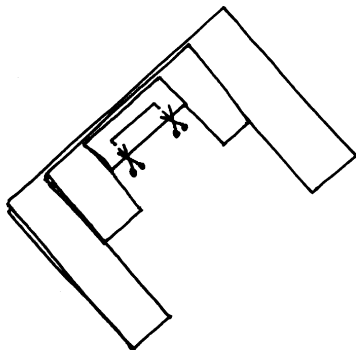

6. Again close the pop-up and make two more slits. Fold a crease between the ends of the slits.

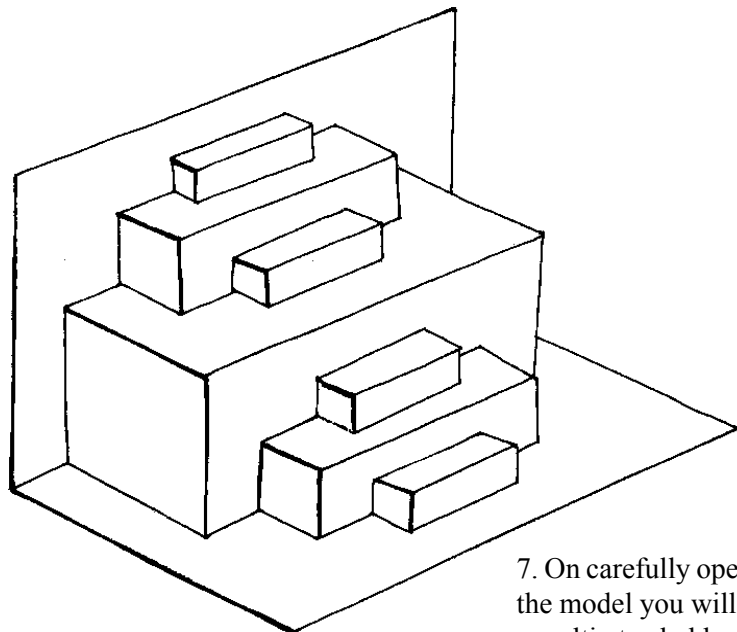

7. On carefully opening the model you will find a multi-step ladder.

## BALANCING NAILS

Can you balance a dozen nails on the head of one nail!  
Sounds impossible! But it can be very easily done.

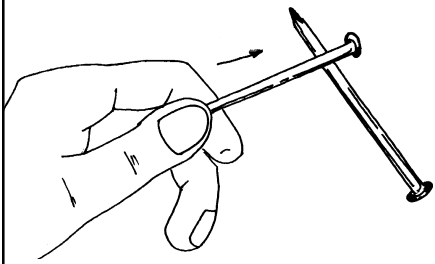

1. Get a dozen 10-cm long nails. Arrange them.....

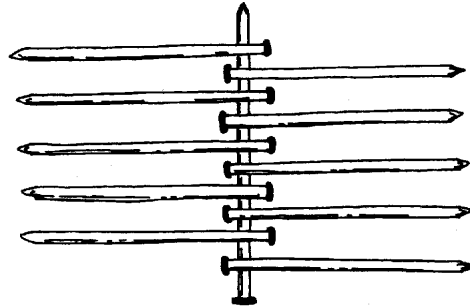

2. ....in the order shown in the picture. Five nails have heads to the right; the other five have heads to the left. This takes care of 11 nails.

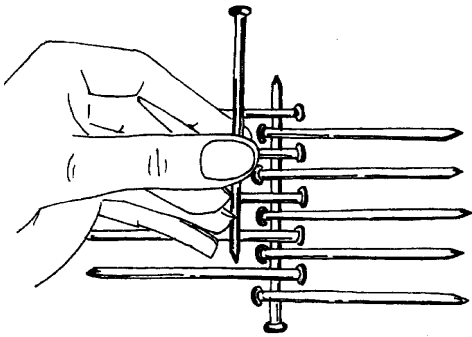

3. The last nail is put exactly in line with the first nail. It rests between the heads of all the nails.

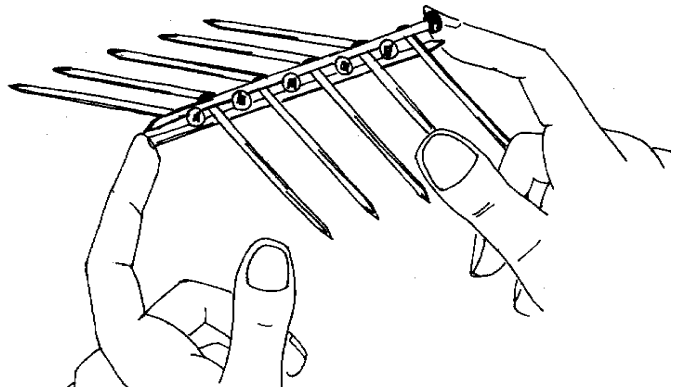

4. Now, grip the ends of the two vertical nails and lift up the entire assembly. You will be surprised to see that the nails jut out like roof poles without falling.

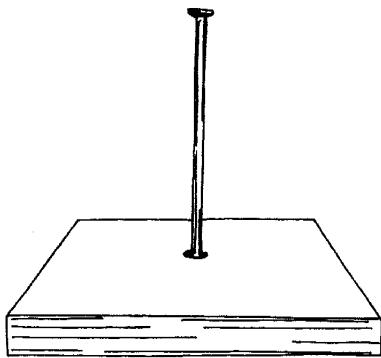

5. On a wooden block hammer a 12-cm long nail.

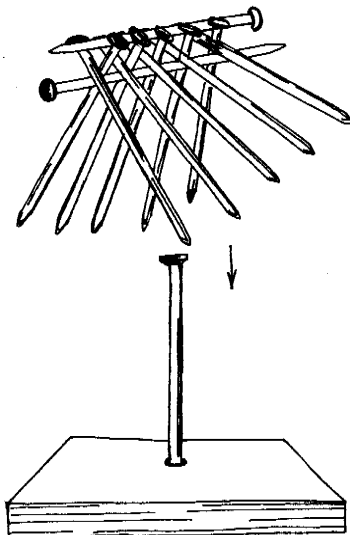

6. Gently place the assembly on the head of this nail.

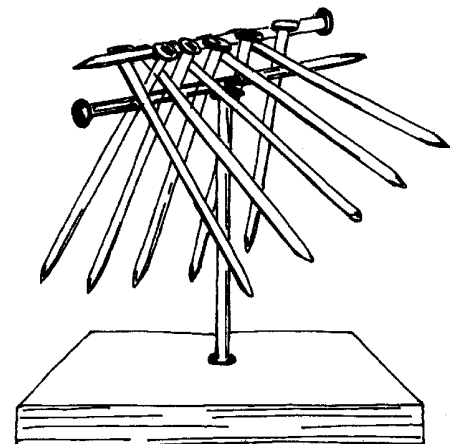

7. You will be surprised to see the entire assembly of a dozen nails neatly rests on the head of one single nail! The assembly is quite stable and you can rock the nails sideways like a swing.



## OSMOSIS BOTTLE

A raisin soaked in water swells up like a grape. This is because of osmosis. The skin of the raisin is semi-permeable. It allows molecules of only a certain size to pass through.

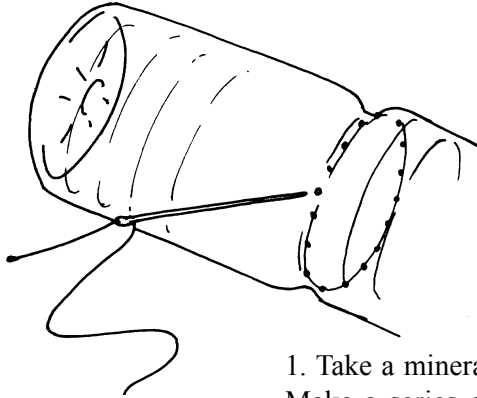

1. Take a mineral water bottle. Make a series of holes in the middle periphery of the bottle.

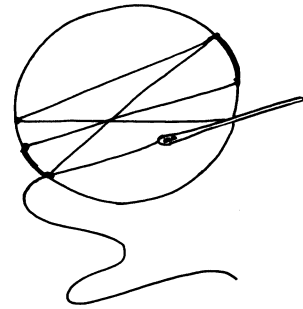

2. With a series of stitches with the needle and thread create a "netting" just like some chairs have. This will act like a sieve.

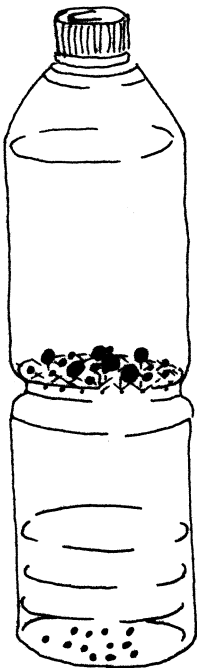

3. Now put some big beads / seeds in the bottle and close its lid.

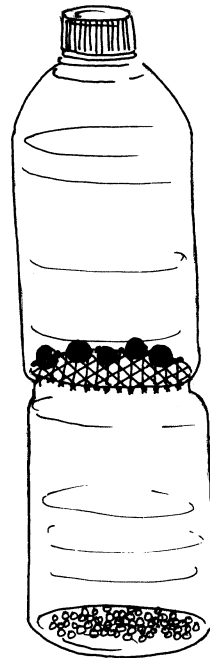

4. On shaking the bottle you will find that all the small beads / seeds go down the sieve and only the big ones remain on top.

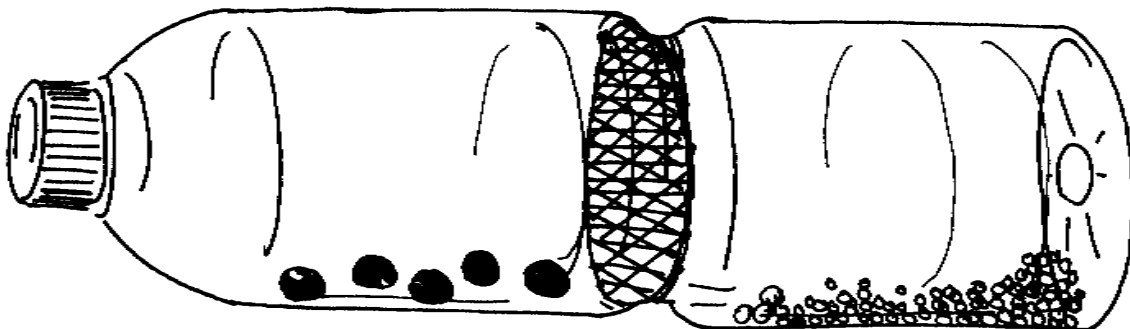

### A TRICKY CIRCLE!

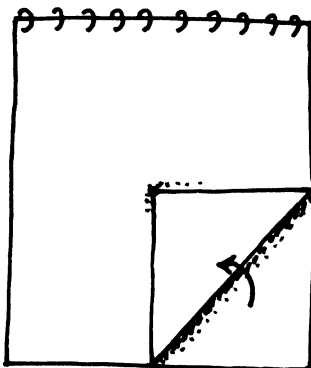

1. Can you draw a circle and its centre without lifting the pencil. This looks impossible but it can be done. Fold the right corner of the paper as shown.

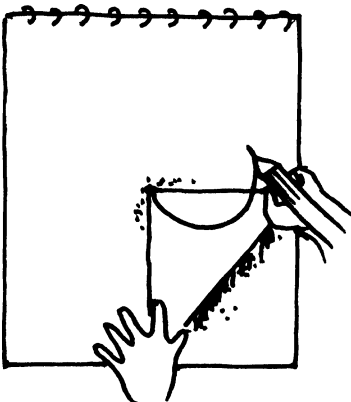

2. Start the centre of the circle from the folded corner and then proceed to draw....

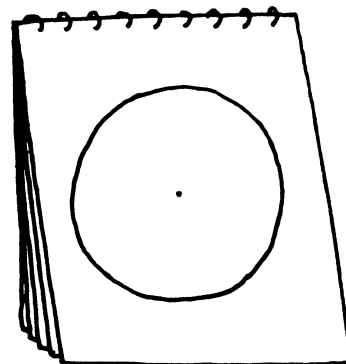

3....the whole circle.

### SINKING AND FLOATING

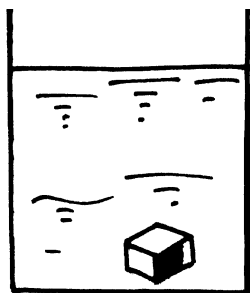

1. A small stone will sink in water.

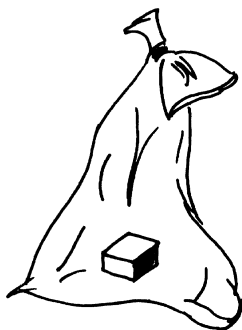

2. Now put the stone in a milk bag. Fill some air in the bag and then tie its mouth. The stone will now float.

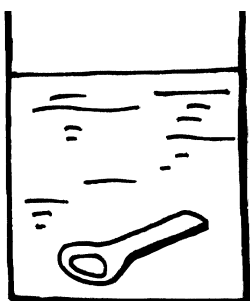
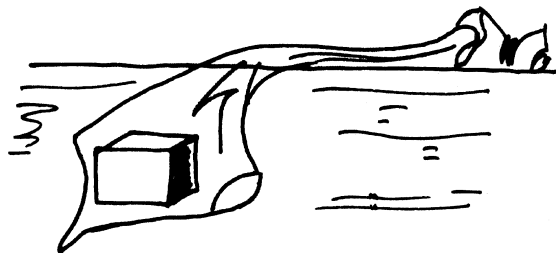

3. A bottle opener made of metal will sink in water.

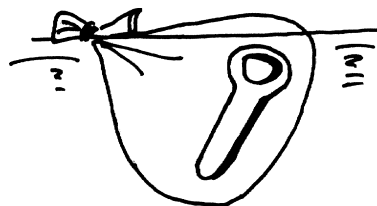

4. Enclose the bottle opener in a plastic bag. Fill some air and close its mouth. The bottle opener will now float.

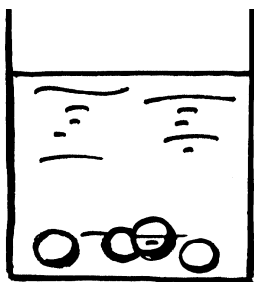

5. Ordinary glass marbles will sink in water.

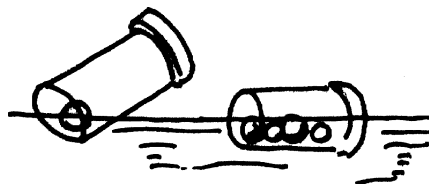

6. But if you put marbles inside plastic film cans then they will float.

## ROCKET PROJECTILE

This is a very dramatic experiment. You just need a PVC pipe, paper, tape and scissors.  
The paper cone “missile” when blown through a pipe flies in a trajectory and lands 15-20 meters away!

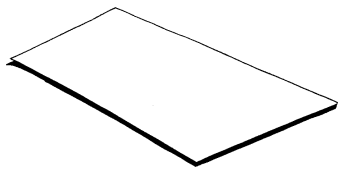

1. Take a 15-cm x 25-cm piece of old Xerox paper.

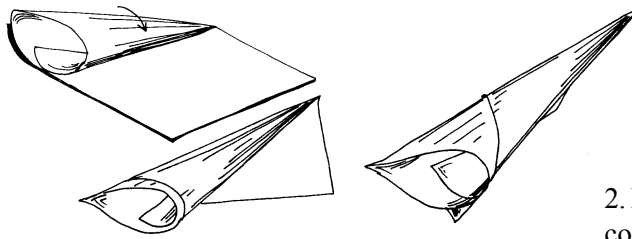

2. Fold it into a long conical shape.

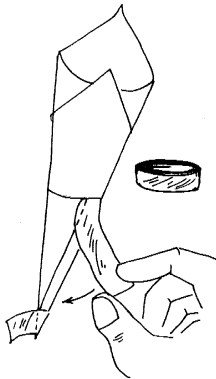

3. Tape the end so that the cone does not open up.

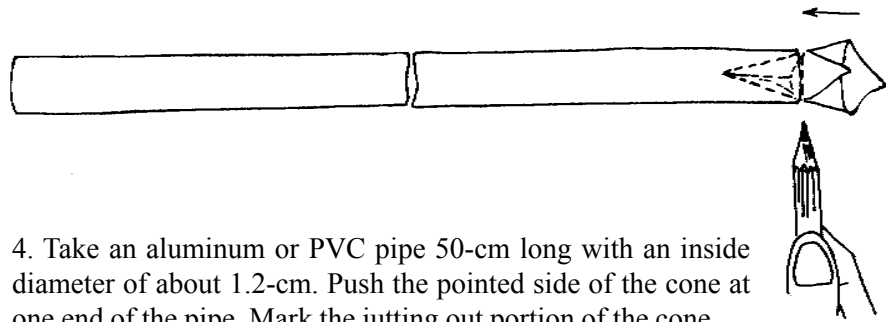

4. Take an aluminum or PVC pipe 50-cm long with an inside diameter of about 1.2-cm. Push the pointed side of the cone at one end of the pipe. Mark the jutting out portion of the cone.

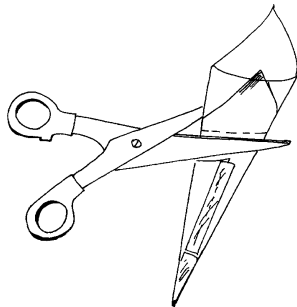

5. Cut the jutting out portion of the paper cone with a scissors.

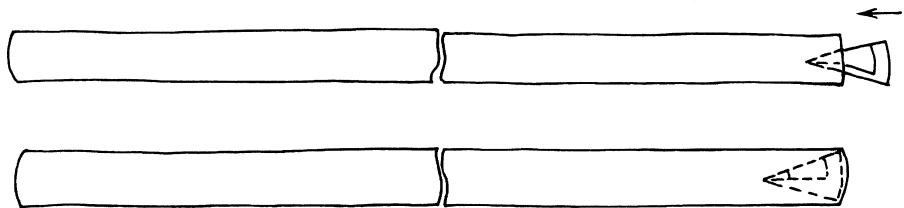

6. Now place the cone with its pointed end inwards at one end of the pipe. Push it inwards until it is flush with the end of the pipe.

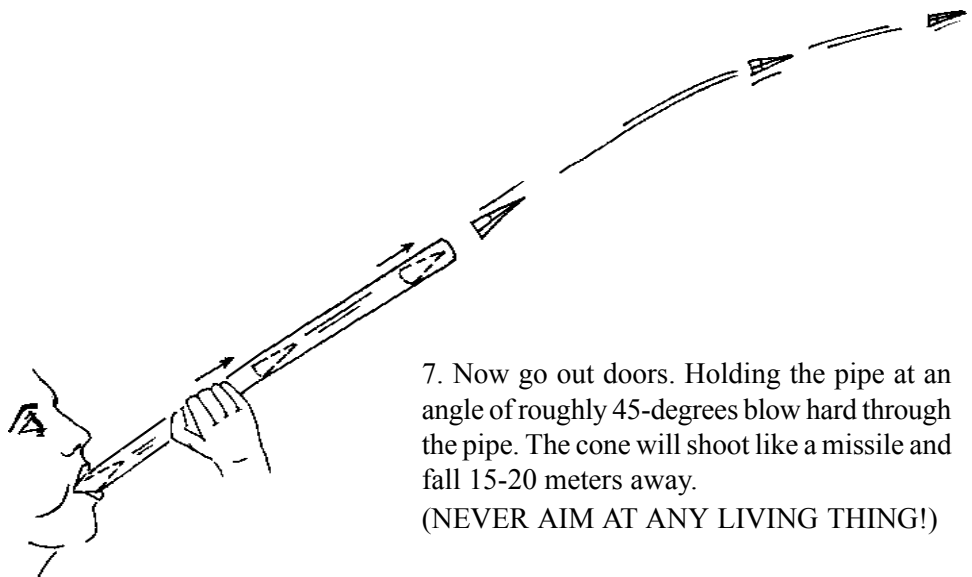

7. Now go out doors. Holding the pipe at an angle of roughly 45-degrees blow hard through the pipe. The cone will shoot like a missile and fall 15-20 meters away.  
(NEVER AIM AT ANY LIVING THING!)

## AIR PROPELLED BOATS

With just a few folds you can make these paper boats.  
 These boats dance under the breeze of the fan and fly from one end of the room to the other.

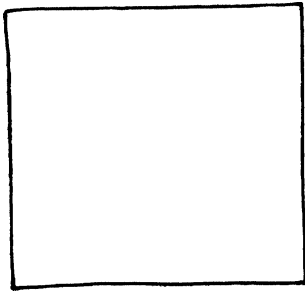

1. Take a square with an edge length of 15-cm.

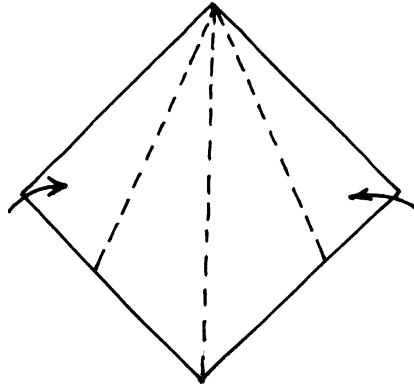

2. Fold its diagonal. Fold the top left and right edges to the diagonal.

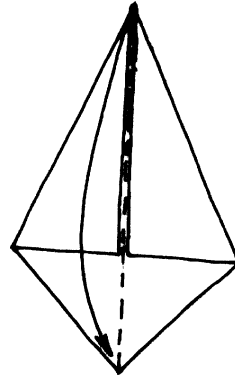

3. Fold the top tip to the bottom point.

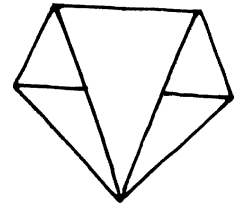

4. Upturn the paper.

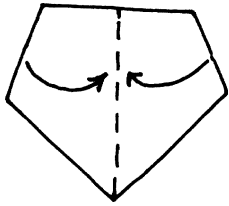

5. Fold left and right edges to the middle line.

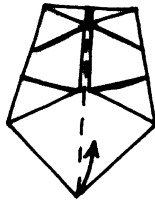

6. Lift the bottom point...

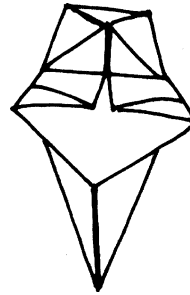

7.... and fold as shown.

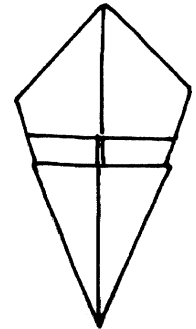

8. To make the air propelled boat.

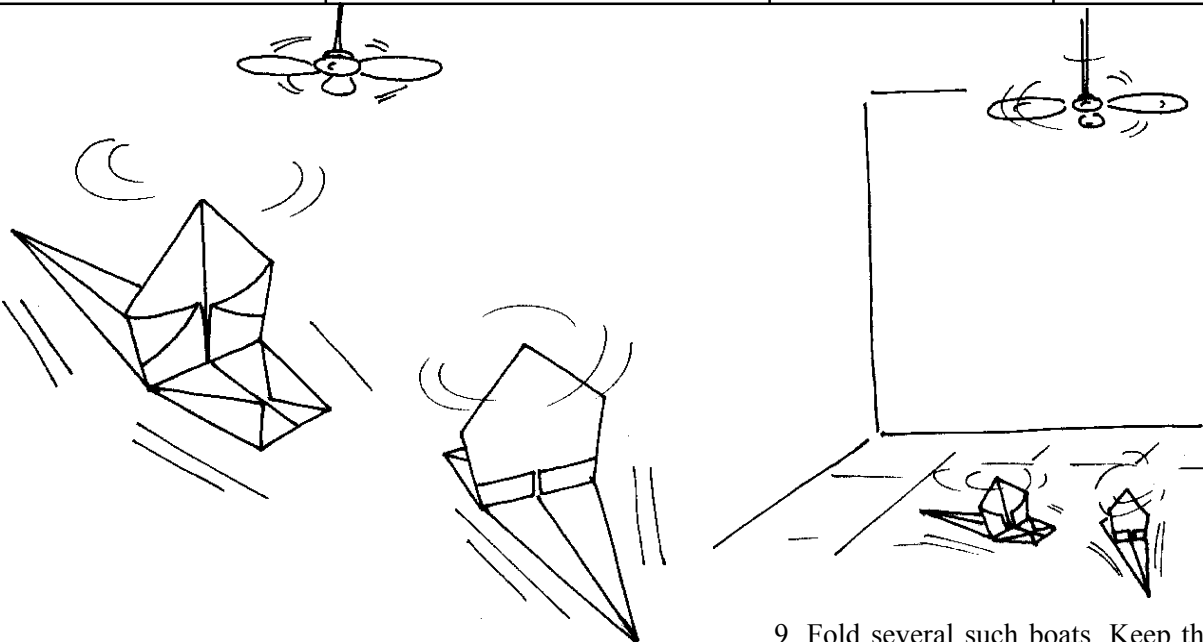

9. Fold several such boats. Keep them on the floor under a fan. These boats will twirl round-and-round and float all over the room.

## BALLOON IN A BOTTLE

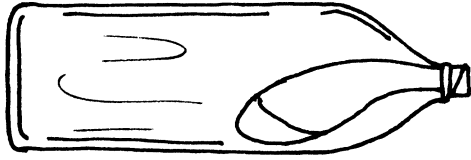

1. Take a glass bottle. Put a balloon inside it. Stretch the opening of the balloon on the mouth of the bottle.

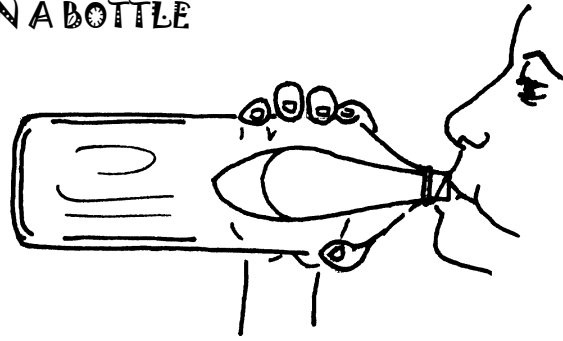

2. Now try and blow the balloon. No matter how strong you are, or how hard you try you will not be able to inflate the balloon. The reason is simple. The air inside the bottle exerts a pressure and prevents the balloon from inflating.

## BLOW OUT!



Hold a candle so that the flame is in the centre of the wide end of a funnel. Now try to blow out the candle.

No matter how hard you huff and puff, the flame doesn't go out. Instead, it strangely flickers towards the funnel. Many fluids have a tendency to flow along a surface. As you blow the air that is blown into the funnel spreads out and hugs the surface of the funnel. Almost none of the air travels down the centre. This is why the flame is not extinguished.

## WASTED BREATH



Put a table tennis (ping-pong) ball in a funnel. Tilt your head and try to blow the ball out of the funnel. Blow with a steady pressure, not with short bursts. The most frustrating part of this experiment is that the harder you try to blow the ball out the more firmly it stays in place. This demonstrates Bernoulli's effect - moving air exerts decreased pressure at right angles to the direction of motion. In this case the rushing air coming out of the funnel hits the surface of the ball. The greater pressure of the atmosphere becomes immediately apparent. It holds the ball in the funnel.

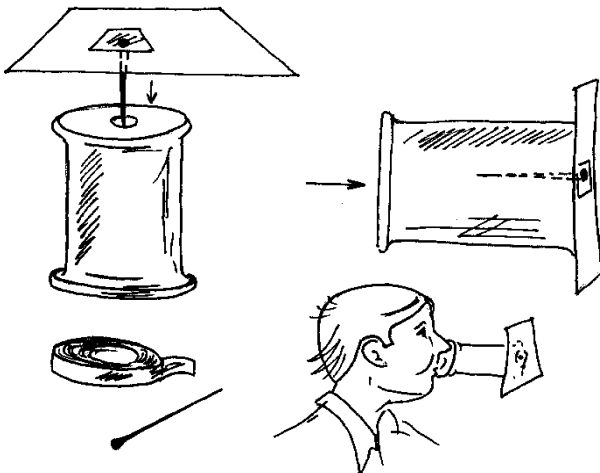

## NO WINDFALL

You will need a 5-cm edge square paper, a pin, some tape and a spool of thread. Put the straight pin through the centre of the paper and tape it in place. Insert the pin in the centre hole of the spool of thread. Tilt the spool upwards slightly as you put the open end to your lips. Try to blow the paper off the end of the spool!

The harder you blow the more securely the paper is drawn against the top of the spool. Air rushes out of the hole, spreads between the paper and the spool and reduces the air pressure. The greater atmospheric pressure on the other side of the paper presses down and holds it firmly against the top of the spool.

## THE MAN WHO LOVED INSECTS

Jean-Henri Fabre was a naturalist par excellence. He studied insects in incredible detail, all in the backyard of his homestead - a scrubland known locally as the *harmas*. His ability to convey the subject with passion and detail are unmatched in entomology. Victor Hugo called him “the insects’ Homer,” and Charles Darwin “an incomparable observer.”

The father of entomology and the "poet of science" Jean-Henri Casimir Fabre was born in Saint Léons in France on December 22, 1823. From his youth he was attracted by the beauty of butterflies and grasshoppers. The young Fabre began his career as a teacher at Carpentras at the age of nineteen.

In 1879 when he was on the verge of retirement Jean-Henri Fabre was able to buy a small barren patch of land - locally known as the “Harmas de Sérignan”. Nothing grew on this sun-scorched and parched land. But this weed laden and thistle-ridden land was full of insects and wasps and other creepy-crawly creatures. It was here that Jean-Henri Fabre devoted the rest his life to the uninterrupted study of his dear insects. Here he could devote himself to all his experiments and reflections in total peace. It was just as he had always dreamed. There he established his family house, his office, and his library. This incomparable place was the perfect environment for Jean-Henri Fabre, poet and scientist. Today it is a museum surrounded by a magnificent botanical garden.

He laboured hard on his passions. He got up early in the morning and after eating a simple breakfast retired for the whole day into his laboratory - a long bare room with whitewashed walls with a big oak table containing insect cages, a magnifying glass and some other trinkets. All his life he relied on a pocket hand lens because he did not have the money to buy a microscope. Towards the end of his life, the French Government bestowed on him the gift of a modern laboratory and a microscope. Fabre was too old by then to make use of it. Time and Patience, were Fabre's best friends.

Once inside his laboratory, Fabre lost track of time. He seldom met visitors or replied to letters. He devoted himself single-mindedly to unravelling the marvels of the insect world. He must have circumbulated the big oak table on which was lodged his laboratory so many times, that towards the end a groove had been dug in the stone floor with the impact of Fabre's heavy peasant boots! The point Fabre wished to make in his research was that insects do not think; *insects behave strictly according to instinct*.

Fabre was fact finder and not a theorist and Darwin's famous book the *Origin of Species* did not interest him one bit. Jean-Henri Fabre was visited at his home by scientists like Pasteur and the President of France.

Fame came to Fabre in his old age. Napoleon III awarded him the Legion of Honour. In 1915, at the age of 92, Jean-Henri Fabre died: he who had dedicated his whole life to the study of insects.

Fabre's life and his monumental work - which runs into more than 2500 pages, would always remain a source of great inspiration to every inquisitive child and adult the world over, more so in a country like India. Fabre's simplicity, his innate humility, his ability to be able to improvise experiments with almost zero-cost equipment holds a great message for everyone in this resource starved country. Fabre did so much with so little. His message is loud and clear - you do not need expensive apparatus to be able to do science experiments. You do not need a PhD to unfathom the mysteries of nature. The great pioneers of science did their work with very simple equipment. It is possible, therefore, to follow their footsteps and learn to do scientific thinking without much expensive or elaborate apparatus. After all the student's mind is the most expensive piece of equipment involved.

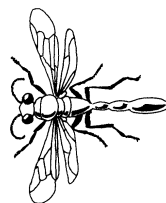
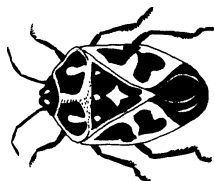
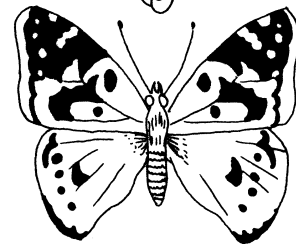
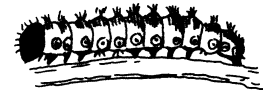
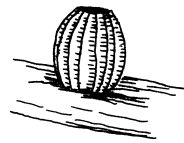

## MATCHSTICK ILLUSION

For this experiment you need one thin rubber band and two matchsticks.

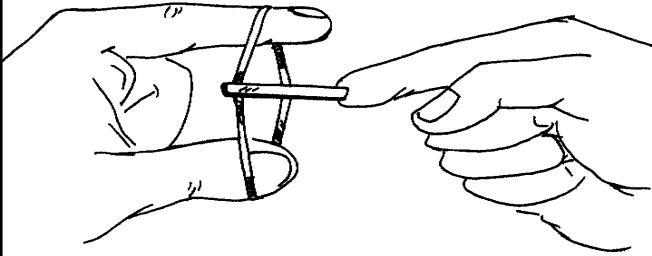

1. Cut the heads off the two matchsticks. This is essential not only for safety but also for the illusion to be successful. Place the rubber band around your thumb and forefinger. Put one matchstick into the loop and wind it up.

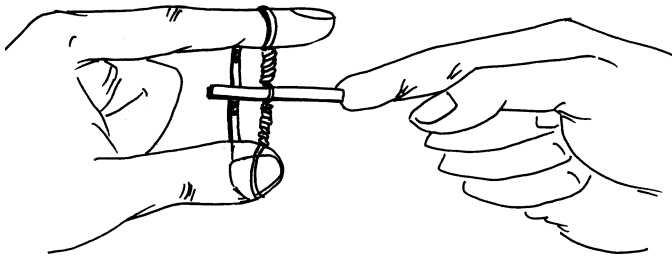

2. Place the other matchstick between thumb and forefinger as shown and rest the wound-up matchstick against it.

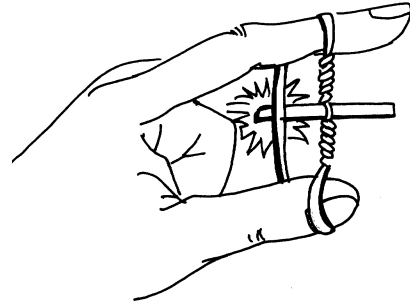

3. When the first matchstick is released, it will appear to slice through the other. The matchstick really travels the long way round, but it does it so quickly that the eye is deceived.

## SQUARE INTO A TRIANGLE

You can make this model using thick rubber, corrugated sheet or thermocole.

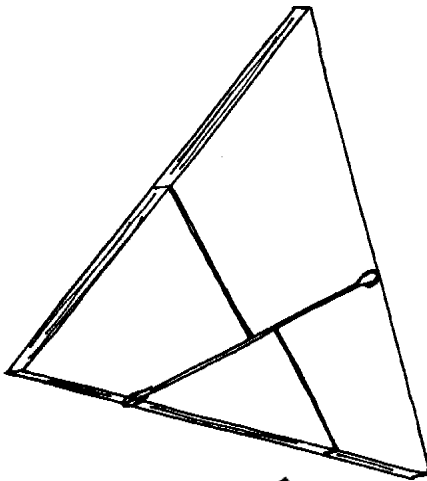

Theoretically any polygon can be transformed into any other polygon by dissection. However, the fun lies in transforming one into the other with the minimum number of cuts. Here a square of shoe sole rubber has been into four pieces. All the pieces are hinged together with small strips of cloth and stuck with a rubber adhesive like *Fevibond*. This arrangement could be easily turned around either to make an equilateral triangle or a square.

It is said that the great British puzzler- *Dudney* had a table like this. If he had 2 guests (he was the third) he would have the configuration of a triangle. With 3 guests he would just turn around the table to make it a square so that 4 people could sit around.

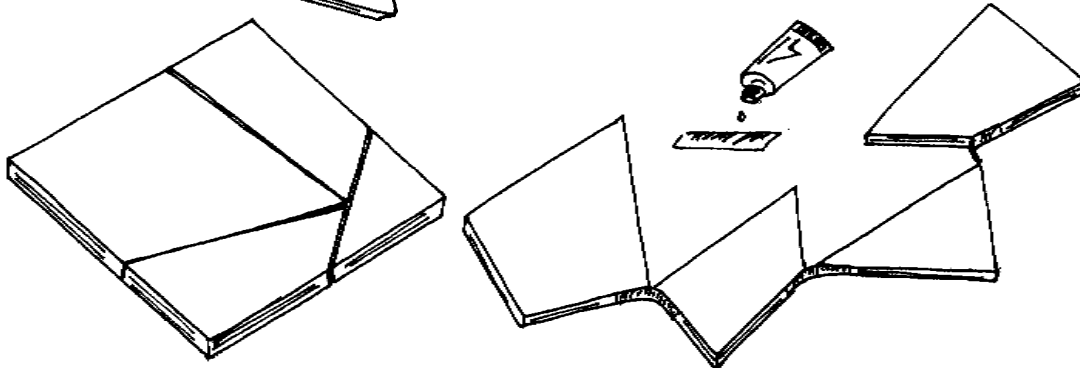

## GRID OF EQUILATERAL TRIANGLES

You could easily fold a grid of equilateral triangles in a paper square.  
Using nets of these triangles, you could fold a number of 3-D shapes Tetrahedrons, Octahedrons etc.

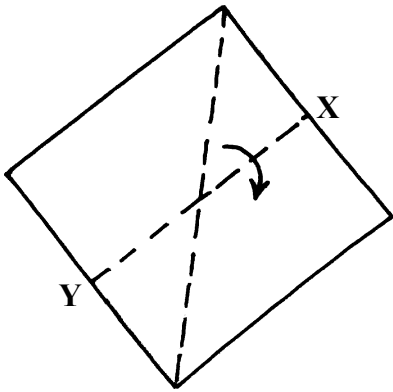

1. Cut the biggest square from an A-4 size Xerox paper. Fold the middle crease to make two equal rectangles.

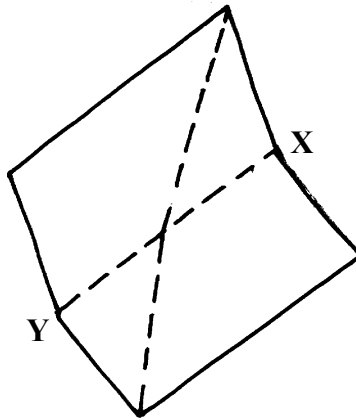

2. Open the square.

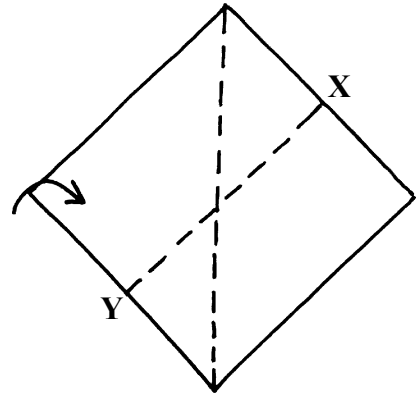

3. Fold the left hand corner and move it on the mid-line (XY) till the left edge passes the bottom corner.

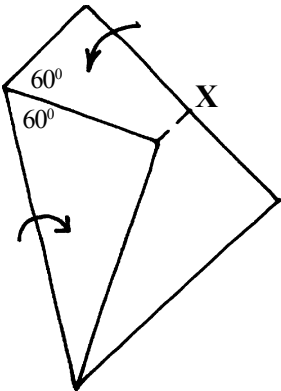

4. This would be the result. This is a wonderful way to crease  $60^\circ$  angles. Fold the top corner such that...

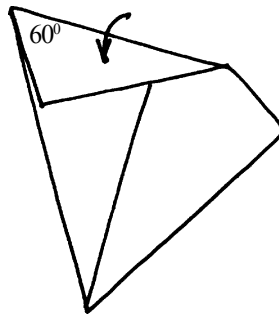

5. ...its edge sits exactly on top of the left edge.

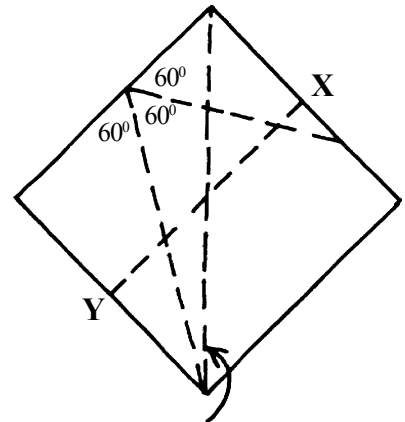

6. On opening the paper you will find the left-top edge divided into three  $60^\circ$  angles.

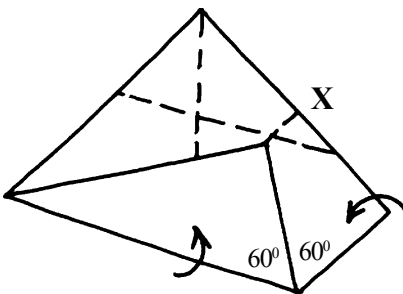

7. Fold the bottom corner and move it on the mid-line (XY) till the bottom edge passes the left corner. Fold the right corner such that...

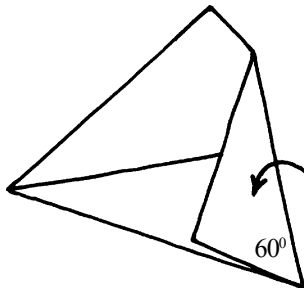

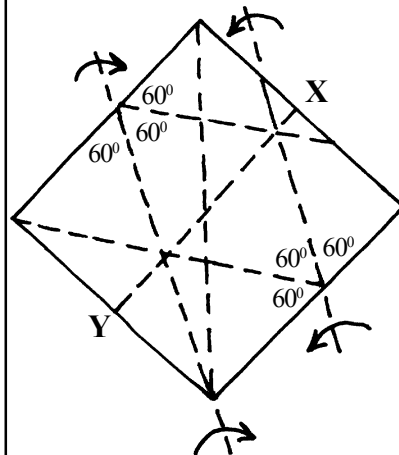

8. ...its edge sits exactly on the top bottom edge.



9. On opening the square you will find several big  $60^\circ$  equilateral triangles. Fold two lines in the directions shown...

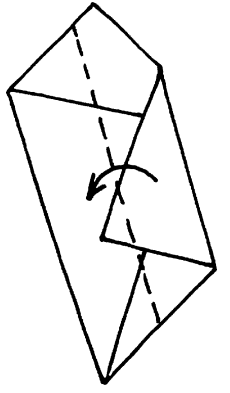
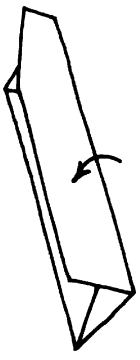
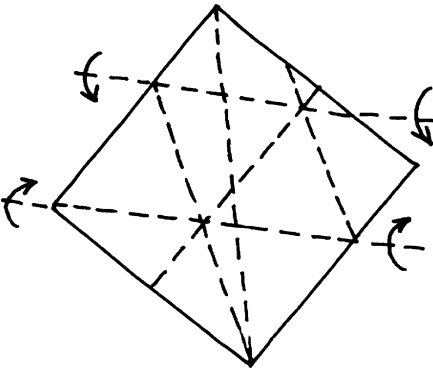
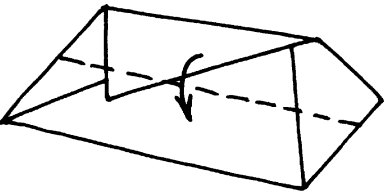

 <p>10...to get this shape.</p>	 <p>11. Fold it again in half.</p>	 <p>12. Open the square and fold two creases in the directions shown...</p>	 <p>13...to get this shape.</p>
--	---	---	--

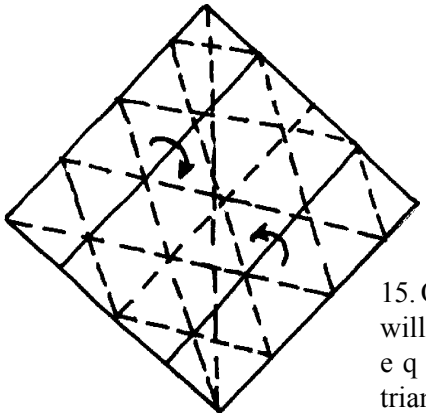
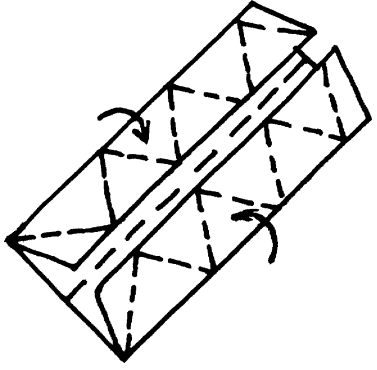
 <p>14. Fold it again in half.</p>	 <p>15. On opening you will find a grid of equilateral triangles. Fold the two lines as shown.</p>	 <p>16. To get a rectangular shape.</p>
--	--	---

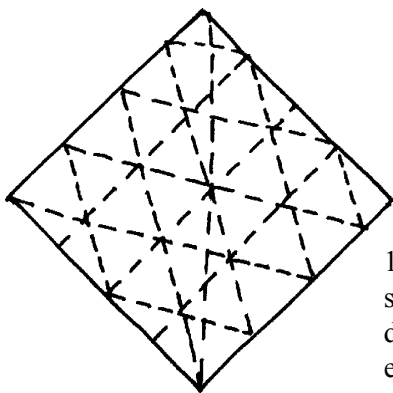
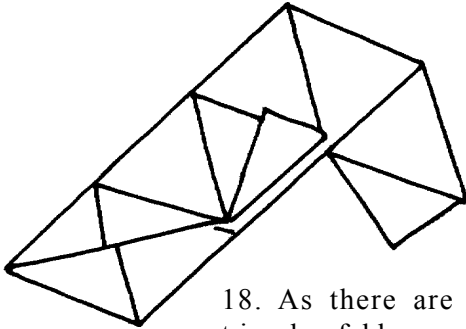
 <p>17. On opening the square will be divided into equilateral triangles.</p>	 <p>18. As there are too many triangles, fold a crease on top of another to reduce their numbers.</p>
--	---

19. Finally assemble a self-locked Tetrahedron, without using any glue or scissors!

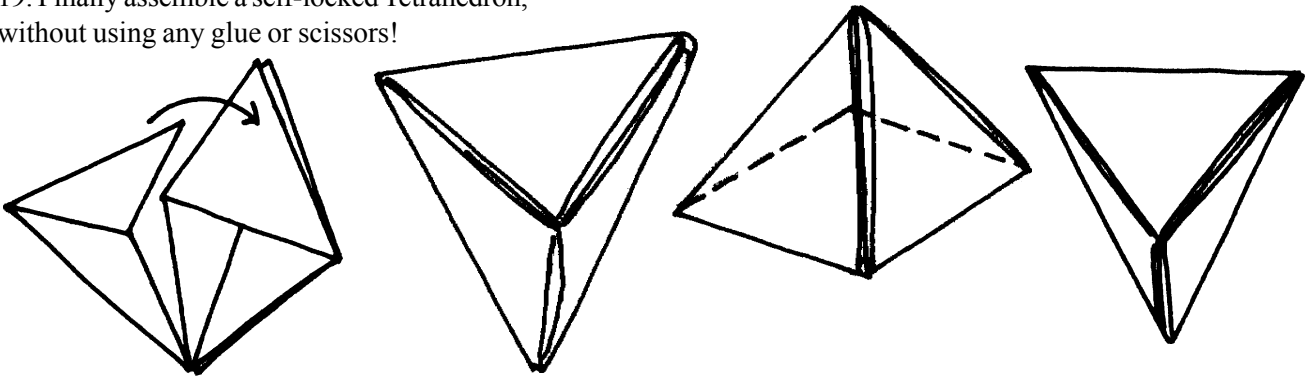

## SYMMETRY

The concept of symmetry can be understood concretely by folding paper, cutting shapes and opening them.

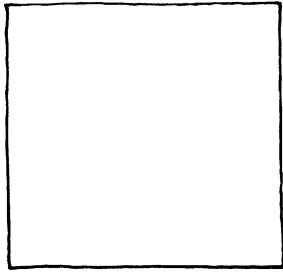

1. Take a sheet of paper.

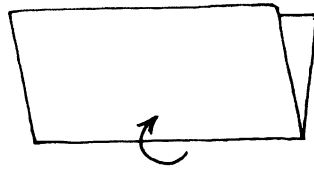

2. Fold it in half.

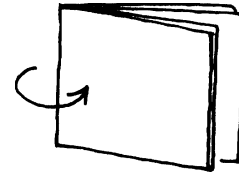

3. Fold it again in half to make a quarter.

4. Fold three sheets in quarters like this. Cut different patterns on the final fold (this fold will have 4-layers). Before opening the cut-out imagine and draw the shape you will see on opening the paper. Did your drawing match the opened out cut-out? Try more such shapes.

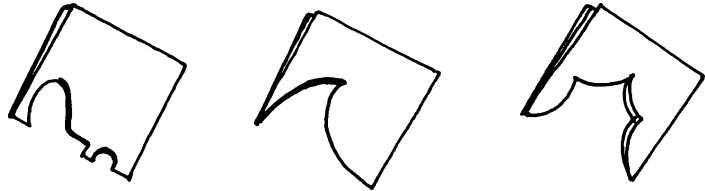

5. Fold another sheet into a quarter. Cut out a triangle from its final fold. On opening the cut-out would you see pattern A or B?

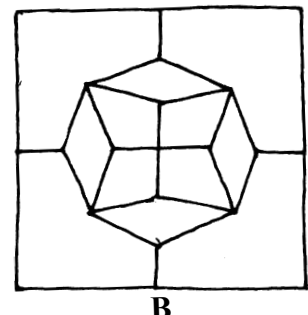
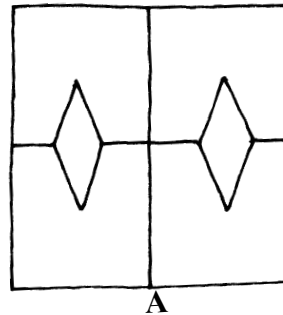
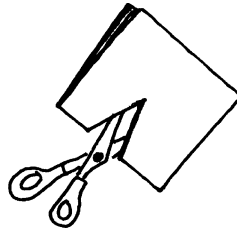

## WHICH HOLDS MORE?

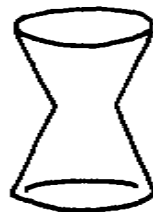
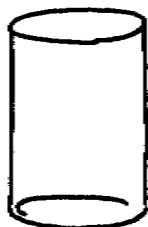
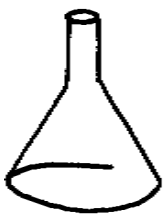

Suppose these six containers were set outside to measure rainfall.  
Which bottle would collect the smallest amount of rain? Which would fill up first?

$$\begin{array}{r}
 15 \\
 36 \\
 + 47 \\
 \hline
 98 \\
 + 2 \\
 \hline
 100 \\
 \hline
 \end{array}$$

Here are digits from 1 to 9 arranged so they equal 100. Can you find another way to do this?

8 5 4 9 1 7 6 3 2 0

What rule was followed when these numbers were arranged?

What number can be added to 7 or multiplied by 7 to give the same answer.

## TWENTY TRIANGLES MAKE A PERFECT SQUARE

Using a little logical math thinking and twenty identical triangular pieces you can arrange them in an orderly fashion to construct a perfect square.

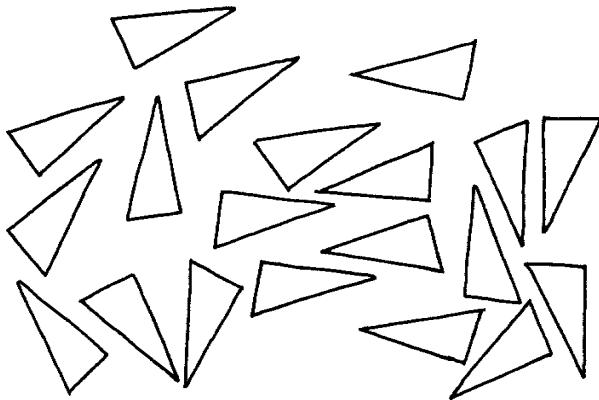
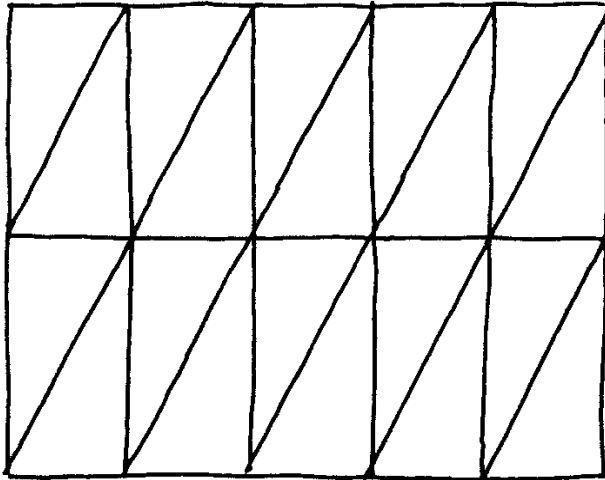

1. Using bond paper make a template of a right angle triangle with 3-cm base and 6-cm height.

2. Trace the template on poster board or plywood or rubber sheet and cut 20 triangles.

3. An easy way to cut the 20 triangles is to first cut a 15-cm x 12-cm rectangle. Divide the rectangle into 20 triangles as shown and cut them.

4. Using all the twenty pieces, form a perfect square. Placing the pieces in random order can be quite difficult. However, there is a clever way to simplify this challenge. Can you figure out what the total area of this square should be? What will be the length of one edge of such a square?

## SIMPLEST MOTOR

This is the simplest electric motor that I have ever seen!

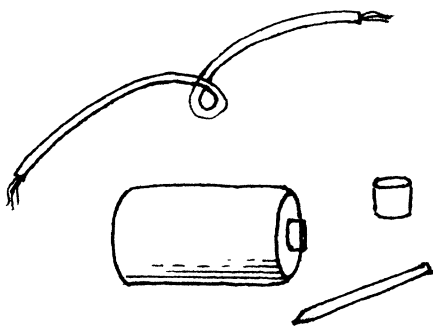

1. You need a 1.5-volt torch battery, a 3-cm long nail, one strong (rare earth) magnet, and a piece of electrical wire to make this amazing motor.

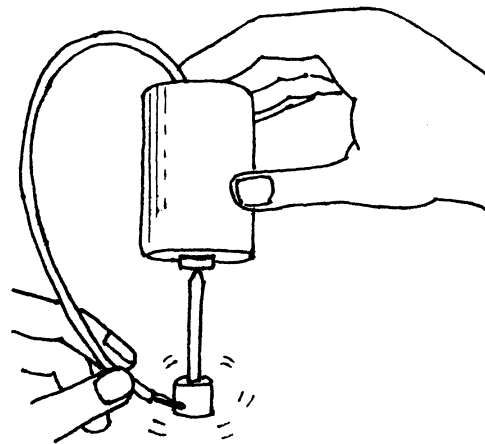

2. Stick the magnet to the flat end of the nail (after cleaning the nail head with fine sandpaper) and hang the pointed end from the battery button (+ve end). Connect one end of the wire to the flat end of the battery and touch the cylindrical of the magnet with the other end. This will make the magnet (and nail) assembly spin at great speed.

## JUMPING RUBBER BAND

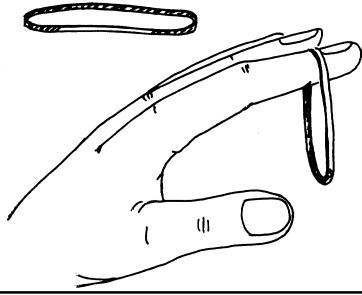

1. Place a medium-sized rubber band in your forefinger.

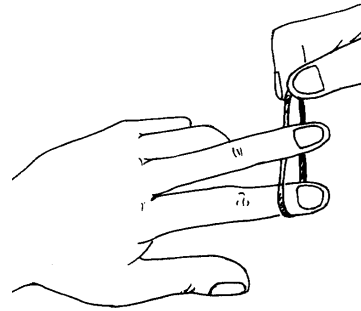

2. Take hold of it with your other hand and pull it up behind your middle finger.

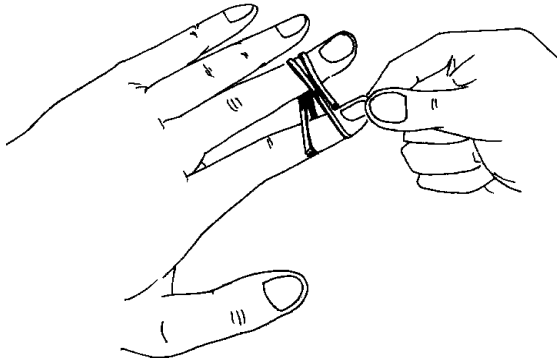

3. Carry it over the middle finger and loop it on to the forefinger once more.

Now tell your friends that you will make the rubber band jump from your forefinger to your middle finger. This will make the trick look more difficult than it really is.

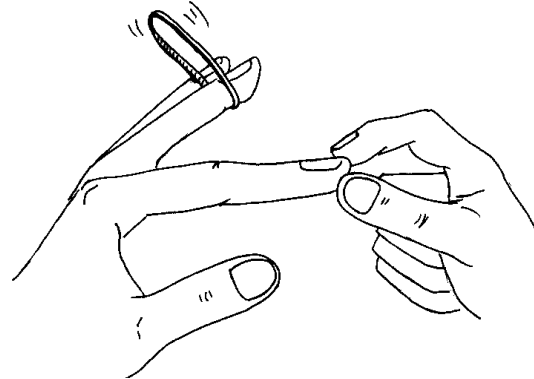

4. Now while chanting a mantra quickly bend your middle finger. Part of the band will slip off which has the effect of releasing it entirely from the forefinger. The band will jump across and hang from the middle finger alone.

## ESCAPING RUBBER BAND

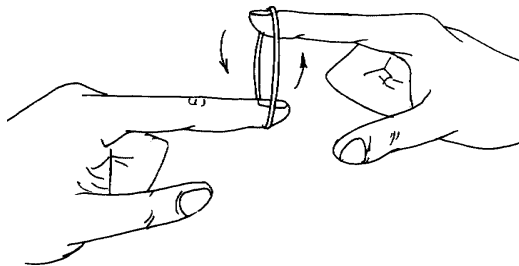

1. Place the forefinger of each hand into the loop of the rubber band and move your fingers in a circle away from you.

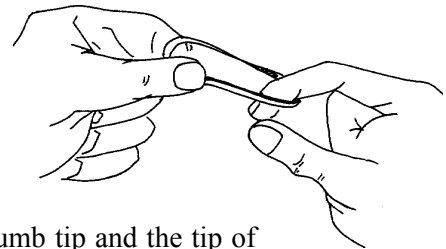

2. Bring the thumb tip and the tip of the forefinger of each hand together.

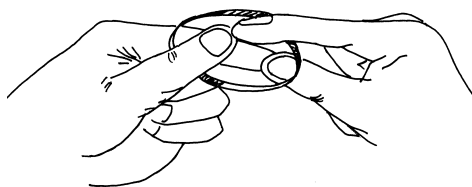

3. Switch fingertips so that the right forefinger touches your left thumb and vice-versa.

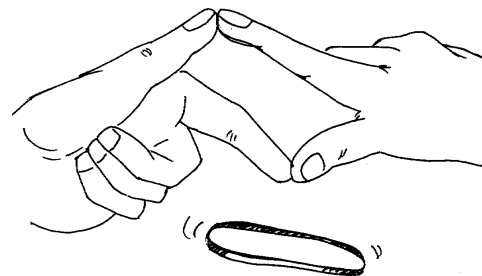

4. Keep the tips together, separate the thumb and fingers to allow the rubber band to drop to the table. Ask a friend to try it. He will probably find the rubber band trapped round his finger!

## SENSITIVE FAN

This turbine is so sensitive that it works by the heat of your hand.



1. Take some very thin paper - carbon paper for instance and cut from it a propellor shown in the drawing.

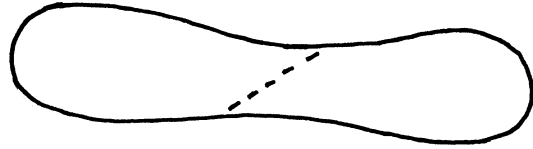

2. Fold it along the dotted line to an angle of about 90-degrees - a carefully rounded crease. The fold must not be sharp, for then the experiment will not work.

3. Lay the propellor lightly on the point of a pencil held upright. The point must be very slightly rounded by one or two gentle strokes on a piece of paper. If the propellor balances well on the point of the pencil and none of it touches the pencil, it begins to revolve. Is it because of your breath? Then try holding your breath! It still goes on turning. Stand it in a cup full of sand, and it stops turning. Pick it up, it begins to turn again because the heat of your hand makes the air rise.

The air turbine is useless above a hot stove, because it is so sensitive. But above your hand or wherever there are gentle rising currents of warm air it works excellently. At the point where the propellor rests on the pencil, its point makes a tiny dent by pressing it very gently, but be careful that you do not make a hole in it. The self-lubricating layer of graphite reduces the friction sufficiently to enable the turbine to react to the slightest current of air.

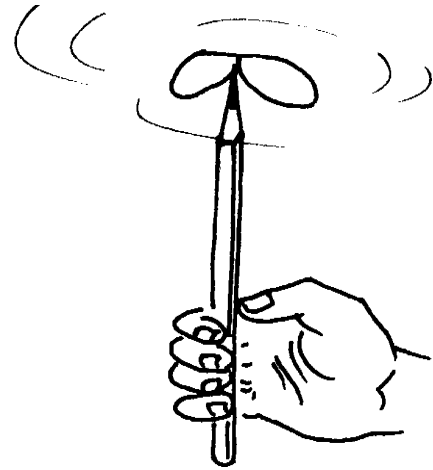

## SHOOTING A RUBBER BAND

This is a very simple trick; but it is great fun to perform.

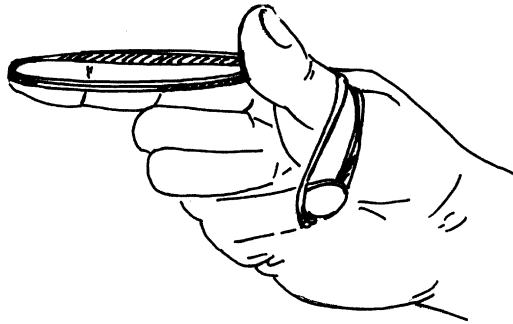

1. Place one end of the rubber band round the tip of your forefinger. Then stretch it around your thumb and down. Hold the other end of the rubber band in place with your little finger.

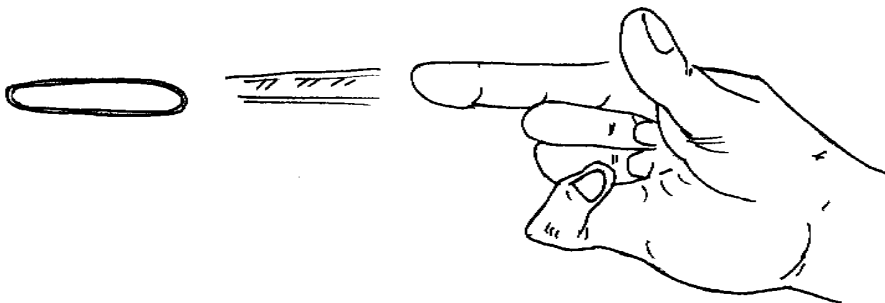

2. Point at a target and raise your little finger. The band will be released and shoot towards whatever target you aim at.

## LIVING ON BOOKS



“How did you happen to lose your family?” Imre asked suddenly.

Szami settled that with a short answer, “I ran away.”

But Imre’s next question was harder. What had Szami been doing for two years? How had he earned a living?

Imre, for the first time in his life, found Szami - of all people - unwilling to talk. It took considerable repetition and urging to get a reply.

“I...I lived,” Szami said at last, “on books.”

“Books!” Imre’s surprise complete. Szami and books were arch enemies, like fire and water; how they had managed to get together was worth finding out. “Books? ...but how could you live on books?”

“Oh...easily enough, by selling them.”

“You mean you were in the book trade?”

“Sort of ...Anyway, I sold them.”

“But how did you get them?”

“...I begged for them.”

It was a strange statement; the ashy moonlight on Szami’s face underlined its strangeness. Imre was at a loss.

“Books?”

“Books?”

Szami finally felt that some explanation was due.

“You see”, he said slowly, “I tried to beg for food, and I couldn’t. The words just wouldn’t come out. I could feel them in my mouth, just ‘Give me bread’ - it had a taste - words themselves were almost like bread. You wouldn’t believe it, but it’s true: they felt lump, as if they were glued to my throat- and couldn’t get out.”

“What did you do?”

“I would try, at one peasant’s house after another - then just ask for the time, thank them and leave - again and again. Then I left the peasants alone. I picked some fruits from the trees along the road and lived on that for days. Then, when I couldn’t stand it any longer, I went to a big house.... You wouldn’t believe the way they looked at you when you start to ask for something and don’t offer anything in return. I never saw that kind of look on a face before...Well, that’s how it started. I saw books lying around on chairs and tables, even on the floor; you could see they were very well liked, those books, or they’d been put on shelves and kept clean.... That’s what gave me the idea. I said I was a student very poor, and I needed books - any books. History or literature or school books - from the Fourth Gymnasium up. That was right for my age, you see; besides, that’s the kind of books they would have. And they gave them to me; I got books at every single house. They wouldn’t have given me food: people would rather give away books. They liked their stomachs better than their heads, and they are much more friendly if you tell them its your mind that’s hungry, if you don’t spoil their dinners by reminding them that they have left you out - that a fellow-being is starving....”

The two boys huddled into their jackets; they were chilly.

“I sold those first books in the next town, without even looking at their titles, just offered them for sale at the first book-store. Then I begged new ones in that town and sold them in the next.

... That time I read a line or two. Later I read whole pages, then whole story. It was interesting, so after that I read them all before I sold them. Some of them were so good that I liked them so much; it broke my heart to sell them. But they were heavy, and though my business was getting better, I was still hungry. So I couldn’t keep any, I just read them.”

He laughed nervously.

“Read them as I hiked ... I’ve read a lot of books in two years - hundreds of them - all while walking. I guess plenty of people can read faster than I can - but not while walking. If there were some competition for walking readers, I’m sure I’d be the champion.”

“Er...hm..er, I bet you would!”

*From: FOOL’S APPRENTICE - by Martin Munkacsi.*

## WHAT DO WE PLANT?

Henry Abbey

What do we plant, when we plant the tree?  
 We plant the ship, which will cross the sea.  
 We plant the mast to carry the sails;  
 We plant the planks to withstand the gales;  
 The keel, the keelson, the beam, the knee;  
 We plant the ship, when we plant the tree.



What do we plant, when we plant the tree?  
 We plant the house for you and me.  
 We plant the rafters, the shingles, the floors;  
 We plant the studding, the laths, the doors;  
 The beams, the siding; all parts that be;  
 What do we do, when we plant the tree?

What do we plant, when we plant the tree?  
 A thousand things that we daily see;  
 We plant the spire that out towers the crag,  
 We plant the staff for our country's flag;  
 We plant the shade, from the hot sun free;  
 We plant all these, when we plant the tree.



## STRANGE CLAY BALL

This traditional toy is a source of eternal delight.

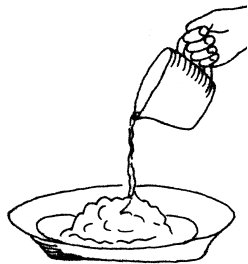

1. Knead clay and make 2-cm diameter clay balls.

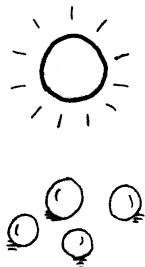

2. Dry them in the sun.

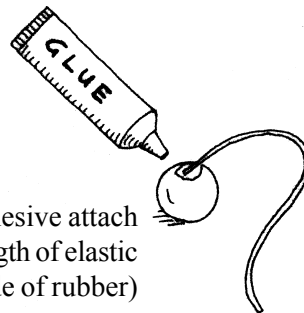

3. With adhesive attach a 20-cm length of elastic thread (made of rubber) to one ball.

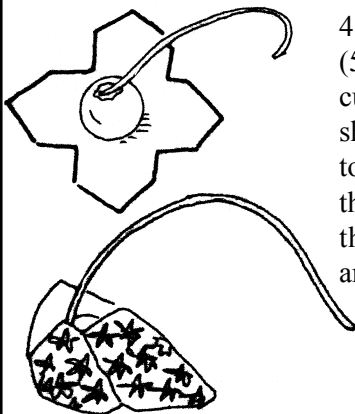

4. Cut thin paper (5-cm x 5-cm) and cut it into a flower shape. Apply glue to the paper. Place the ball and wrap the paper tightly around it.

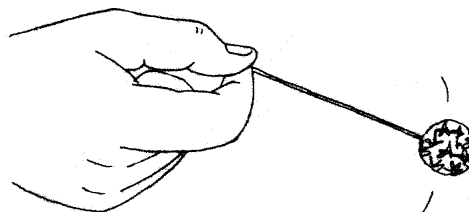

5. Now place the ball on the table and hold the free end of the elastic. Then roll the ball, round-and-round in circles. The elastic will get twisted.

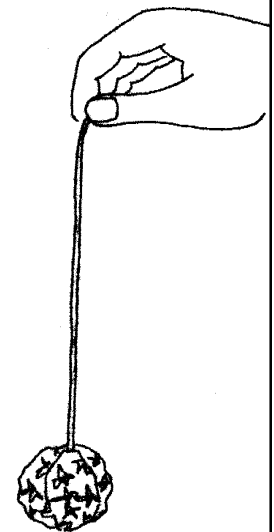

6. Now if you hold the free end of the elastic the ball rotate and the elastic makes amazing vibrating patterns.

# PERIODIC TABLE OF THE ELEMENTS

Dmitri Mendeleev (1834-1907)

The Russian Chemist, Dmitri Mendeleev, was the first to observe that if elements were listed in order of atomic mass, they showed regular (periodical) repeating properties. He formulated his discovery in a periodic table of elements, now regarded as the backbone of modern chemistry.











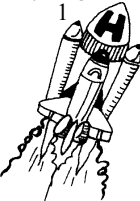









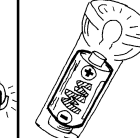

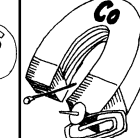



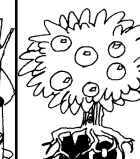
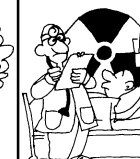
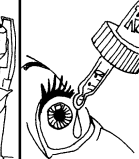

The crowning achievement of Mendeleev's periodic table lay in his prophecy of then, undiscovered elements. In 1869, the year he published his periodic classification, the element gallium, germanium and scandium were unknown. Mendeleev left spaces for them in his table and even predicted their atomic masses and other chemical properties. Six years later, gallium was discovered and his predictions were found to be accurate. Other discoveries followed and their chemical behaviour matched that predicted by Mendeleev.

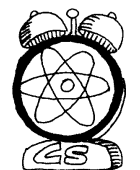
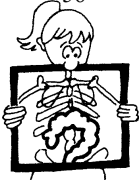
The remarkable man, the youngest in a family of 17 children, has left the scientific community with a classification system so powerful that it became the cornerstone in chemistry teaching and the predication of new elements ever since.

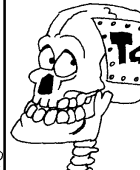
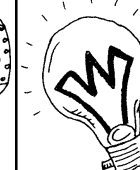
In 1955, element 101 was named after him: Md - Mendelevium.

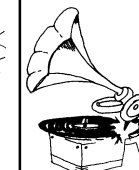
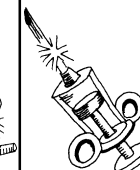
In this remarkable chart, originally prepared by the South African Agency for Science & Technology Advancement (SASTA) the elements are shown with an item of daily use. The symbols, names and atomic numbers of the elements are given.

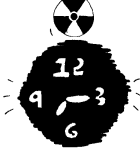
*Redrawn by - Dr. Vidula Mhaiskar*

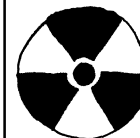
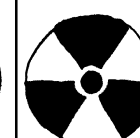
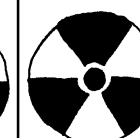
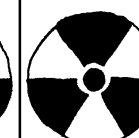
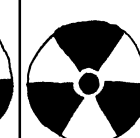
<b>H</b> Hydrogen 1 									
<b>Li</b> Lithium 3 	<b>Be</b> Beryllium 4 								
<b>Na</b> Sodium 11 	<b>Mg</b> Magnesium 12 								
<b>K</b> Potassium 19 	<b>Ca</b> Calcium 20 	<b>Sc</b> Scandium 21 	<b>Ti</b> Titanium 22 	<b>V</b> Vanadium 23 	<b>Cr</b> Chromium 24 	<b>Mn</b> Manganese 25 	<b>Fe</b> Iron 26 	<b>Co</b> Cobalt 27 	
<b>Rb</b> Rubidium 37 	<b>Sr</b> Strontium 38 	<b>Y</b> Yttrium 39 	<b>Zr</b> Zirconium 40 	<b>Nb</b> Niobium 41 	<b>Mo</b> Molybdenum 42 	<b>Tc</b> Technetium 43 	<b>Ru</b> Ruthenium 44 	<b>Rh</b> Rhodium 45 	
<b>Cs</b> Caesium 55 	<b>Ba</b> Barium 56 	Lanthanide Series  <b>L</b>	<b>Hf</b> Hafnium 72 	<b>Ta</b> Tantalum 73 	<b>W</b> Tungsten 74 	<b>Re</b> Rhenium 75 	<b>Os</b> Osmium 76 	<b>Ir</b> Iridium 77 	
<b>Fr</b> Francium 87 	<b>Ra</b> Radium 88 	Actinide Series  <b>A</b>	<b>Rf</b> Rutherfordium 104 	<b>Db</b> Dubnium 105 	<b>Sg</b> Seaborgium 106 	<b>Bh</b> Bohrium 107 	<b>Hs</b> Hassium 108 	<b>Mt</b> Meitnerium 109 	

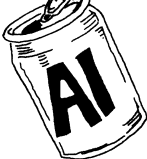

															<b>He</b> Helium 2 
															<b>B</b> Boron 5 
<b>Al</b> Aluminium 13 	<b>Si</b> Silicon 14 	<b>P</b> Phosphorus 15 	<b>S</b> Sulphur 16 	<b>Cl</b> Chlorine 17 	<b>Ar</b> Argon 18 										
<b>Ni</b> Nickel 28 	<b>Cu</b> Copper 29 	<b>Zn</b> Zinc 30 	<b>Ga</b> Gallium 31 	<b>Ge</b> Germanium 32 	<b>As</b> Arsenic 33 	<b>Se</b> Selenium 34 	<b>Br</b> Bromine 35 	<b>Kr</b> Krypton 36 							
<b>Pd</b> Palladium 46 	<b>Ag</b> Silver 47 	<b>Cd</b> Cadmium 48 	<b>In</b> Indium 49 	<b>Sn</b> Tin 50 	<b>Sb</b> Antimony 51 	<b>Te</b> Tellurium 52 	<b>I</b> Iodine 53 	<b>Xe</b> Xenon 54 							
<b>Pt</b> Platinum 78 	<b>Au</b> Gold 79 	<b>Hg</b> Mercury 80 	<b>Tl</b> Thallium 81 	<b>Pb</b> Lead 82 	<b>Bi</b> Bismuth 83 	<b>Po</b> Polonium 84 	<b>At</b> Astatine 85 	<b>Rn</b> Radon 86 							
<b>L</b>	<b>La</b> 57	<b>Ce</b> 58	<b>Pr</b> 59	<b>Nd</b> 60	<b>Pm</b> 61	<b>Sm</b> 62	<b>Eu</b> 63	<b>Gd</b> 64	<b>Tb</b> 65	<b>Dy</b> 66	<b>Ho</b> 67	<b>Er</b> 68	<b>Tm</b> 69	<b>Yb</b> 70	<b>Lu</b> 71
Lanthanide Series															
<b>A</b>	<b>Ac</b> 89	<b>Th</b> 90	<b>Pa</b> 91	<b>U</b> 92	<b>Np</b> 93	<b>Pu</b> 94	<b>Am</b> 95	<b>Cm</b> 96	<b>Bk</b> 97	<b>Cf</b> 98	<b>Es</b> 99	<b>Fm</b> 100	<b>Md</b> 101	<b>No</b> 102	<b>Lr</b> 103
Actanide Series															

## CRAZY MAGNET

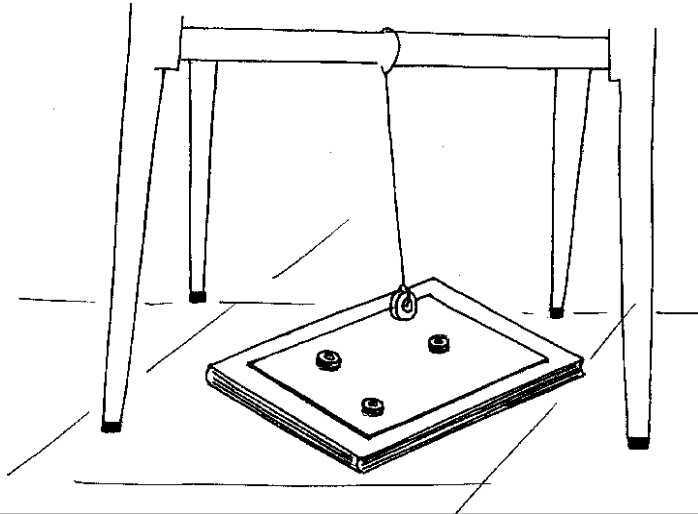

Hang a magnet from the cross bar of a chair using a 30-cm length of thread. Place a tin or steel sheet on the floor. Stick a few magnets on this sheet. Raise it by placing books below so that there is just a little gap between the hung magnet and the magnets on the sheet. Now swing the hanging magnet. It will be attracted by some and repelled by some of the base magnets. The result would be a crazy magnet - which follows a fuzzy logic and wanders as if it were drunk!

## SOMETHING FISHY!

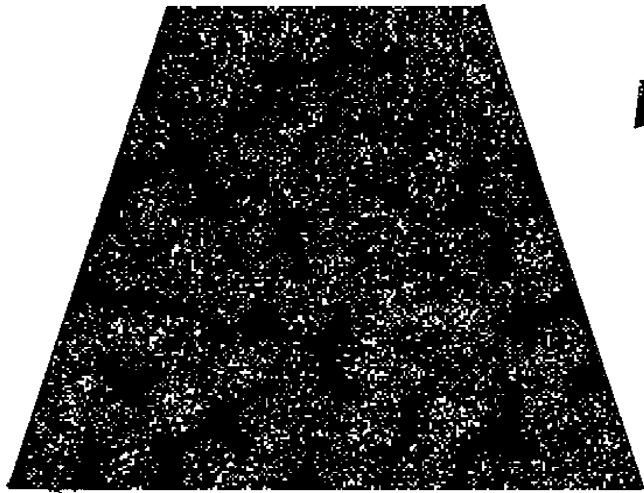

Take a sheet of mottled paper - white dots on a black background. From the same paper cut a fish. Now place the fish on the same mottled paper and cover it with transparent glass. Ask your friends to locate the fish. It will be very difficult to locate the camouflaged fish.

## MINUTE MEASUREMENTS

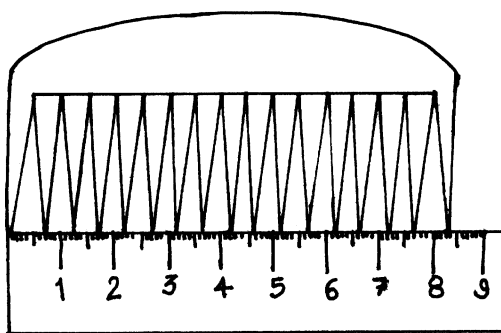

1. How would you measure the distance between two teeth of a comb. One way is to measure the length of the comb, and divide it by the number of teeth. This will give a fairly accurate answer.

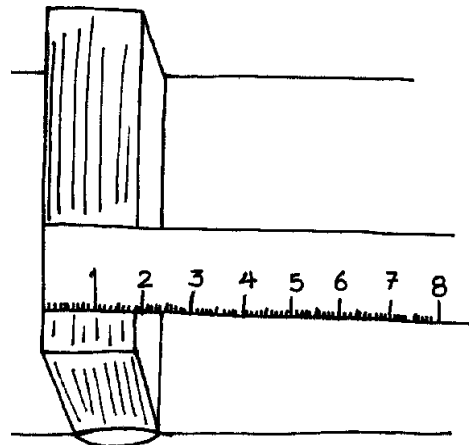

2. How to find the thickness of one sheet of paper? Measure the thickness of the whole book (minus the cardboard covers) and divide it by the number of pages. This will give the thickness of one sheet of paper.

## STANDING A STICK

Which stick balances better - a short or a long one? Where do you add weight to make it more stable?

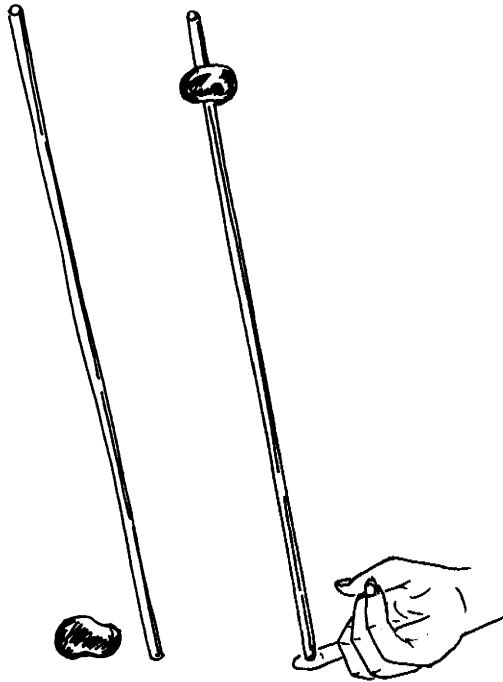

Your ability to balance a stick on your finger depends on the length of the stick. You can verify this by trying out sticks of different lengths. It is easy to balance a metre stick, but difficult to balance a foot ruler, and simply impossible to balance a pencil.

Longer sticks have a smaller angular acceleration, and are thus easier to balance than short ones. However, if a clay ball is fixed to the top end of the stick, it gets easily balanced.

## A HANDY DRAWING GLASS

To trace an object you need a piece of clear glass and some drawing instruments.

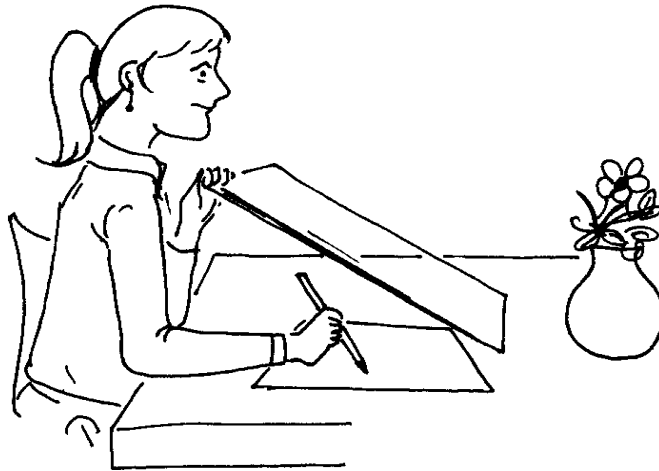

It is wonderful to draw, to put your ideas in line on paper and to give visible form to what goes through your mind. It is far more satisfying than getting a quick photocopy or a print. But what can be great fun, too, is to draw from nature, though you need not try and copy all the shapes exactly. If, however, you do want to copy something very accurately, for example a vase, then a piece of transparent glass can be very handy. For a piece of glass makes a very good transparent mirror!

The drawing shows you how to set things. Above the sheet of paper on which you are going to draw, hold the piece of glass at an angle. Look at the glass and you will see the vase - upside down - and, at the same time, the paper. The glass reflects like a mirror, but much more faintly. If you do not move the glass, and also hold your head still, you can draw the outline of the vase which you see in the glass almost as easily and accurately as when you trace something.

# THUMBPRINTS

Using your thumbprints make some exquisite pictures.

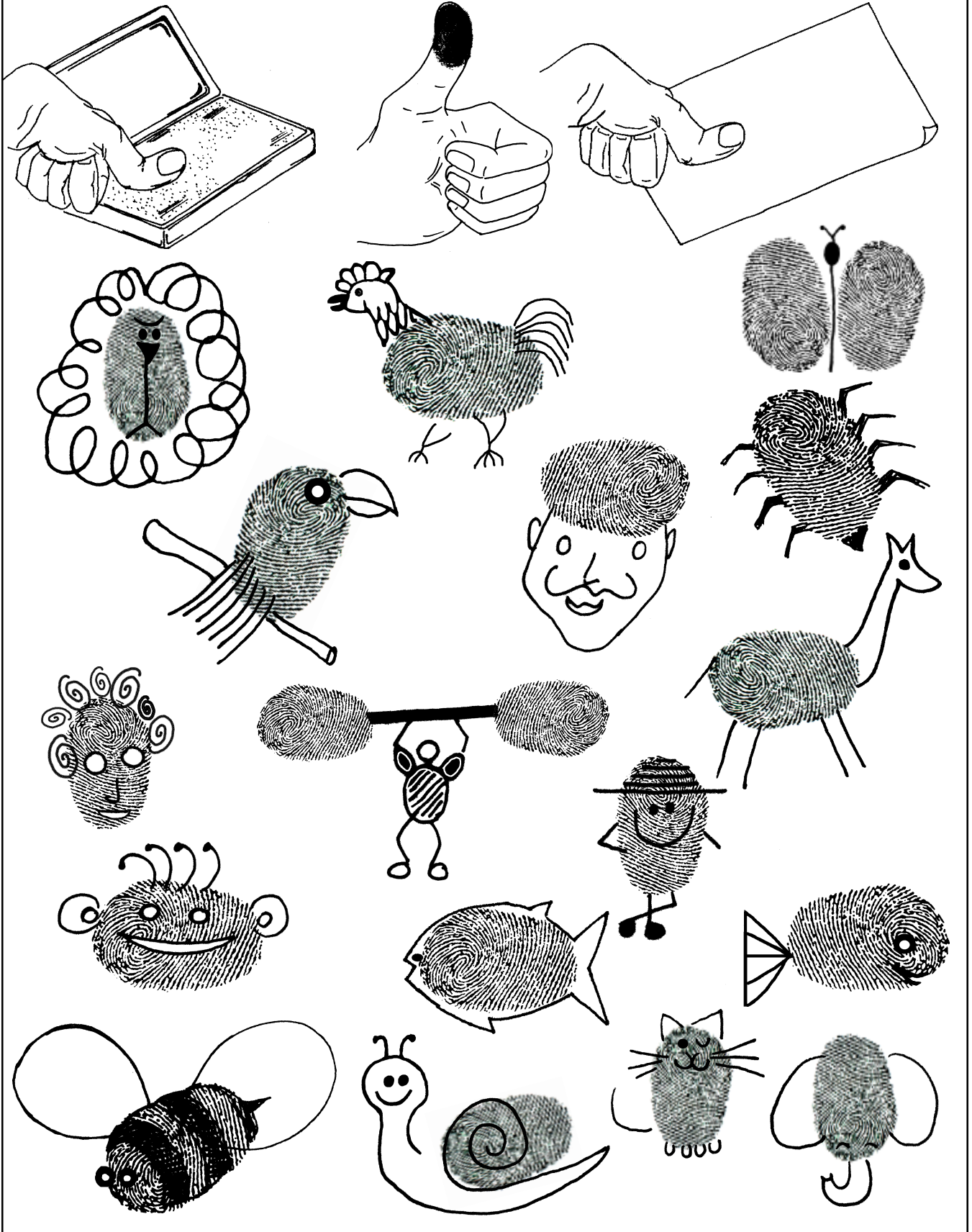

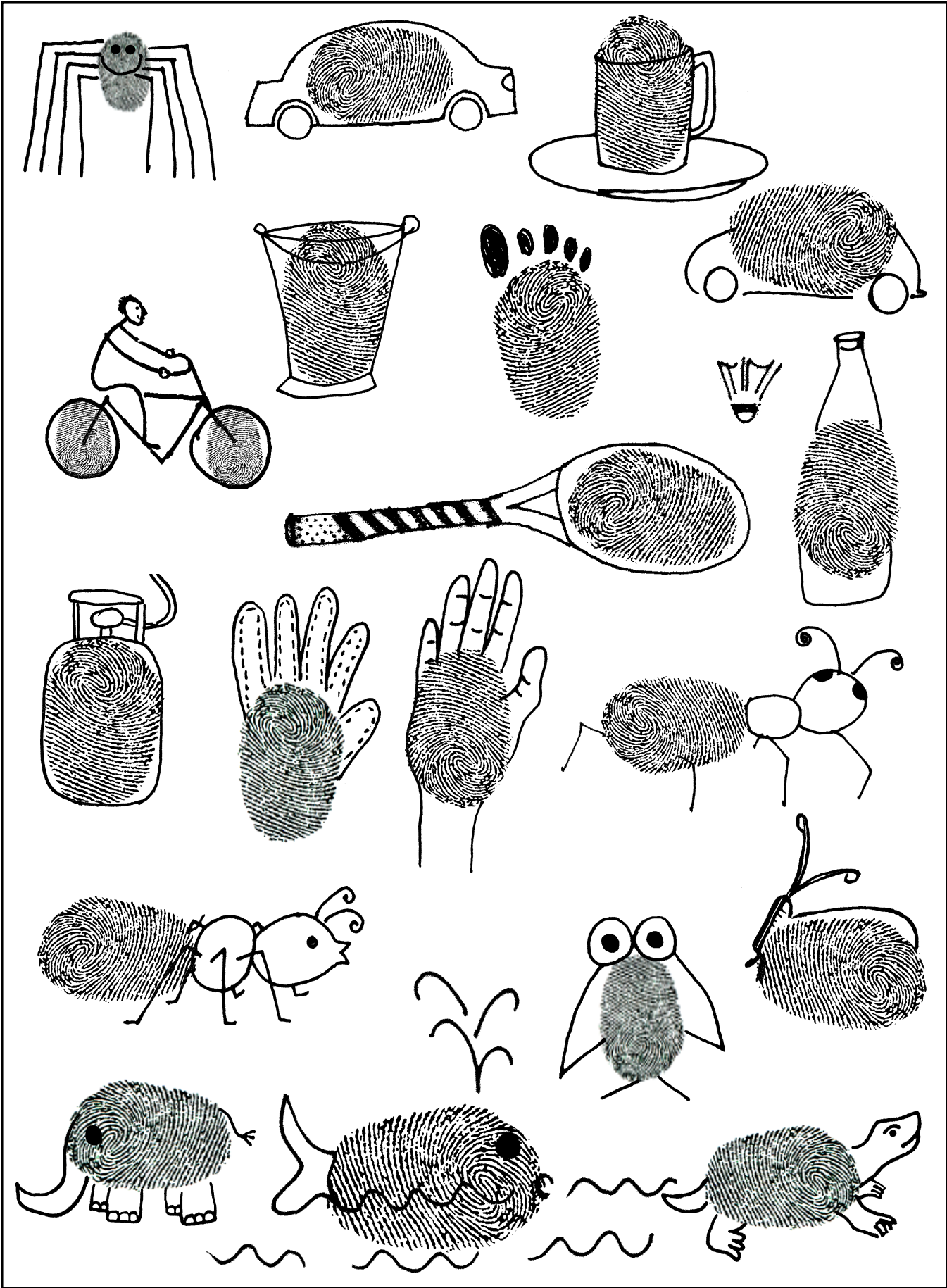

## LETTER Y TREE

Stand up and stretch your arms to the sky. You are like a tree with a trunk and branches.  
Trees are easy to make if you start with the letter Y.

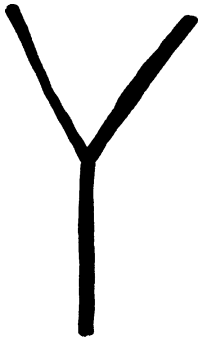

1. Use a thick sketch pen (preferably of brown colour) to make a Y that is as tall as your paper.

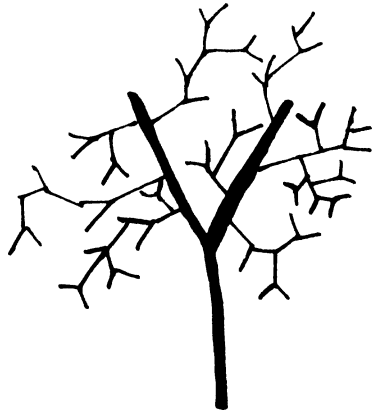

2. Make lots of small Y shaped branches in the tree. Some branches will be sideways, others will be upside-down. The Y's will become smaller and smaller as you proceed and go towards the end of the branches.

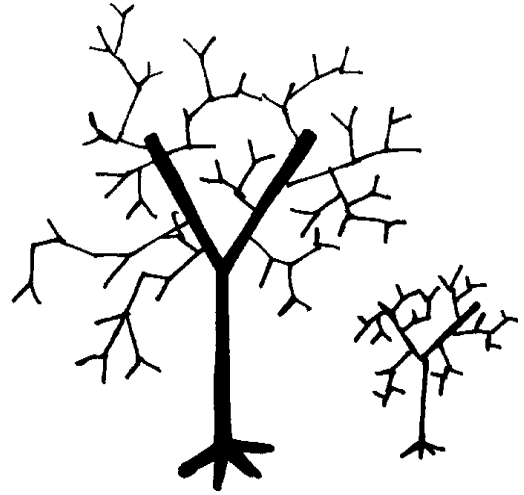

3. Anchor your tree trunk to the ground by giving it roots. Make another small Y tree in the background. Does it look further away?

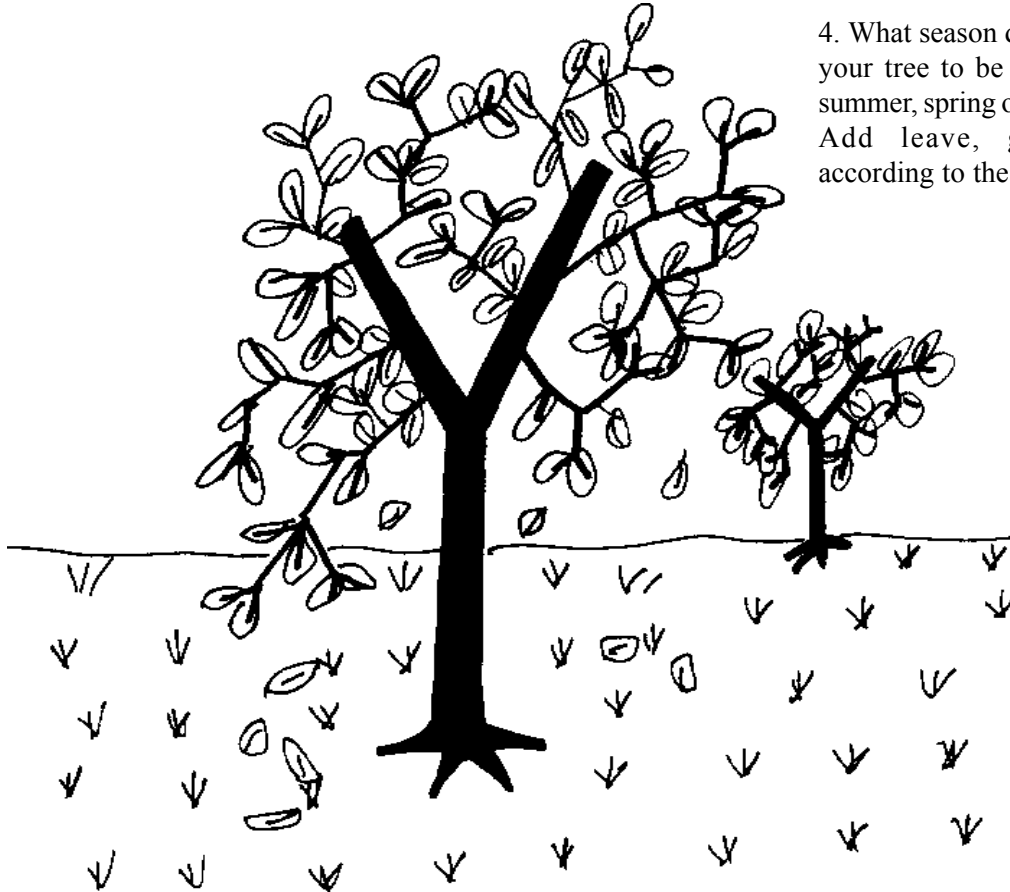

4. What season do you want your tree to be in? Winter, summer, spring or monsoon? Add leaf, grass etc. according to the season.

## BALANCING A METRE SCALE

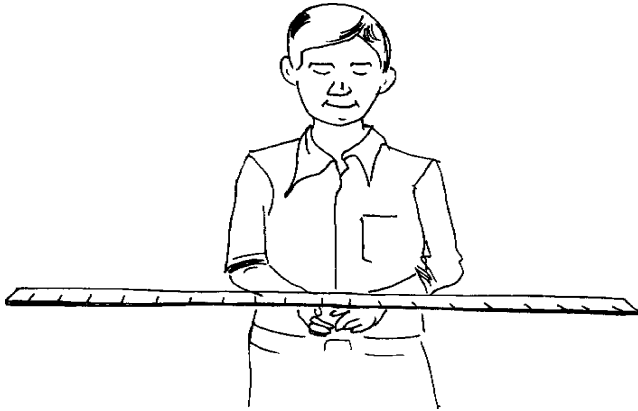

1. Rest the ends of a metre-scale on your index fingers. Slowly bring your fingers towards each other. They will meet at the exact centre every time. Why does this happen? As you slide your fingers and bring them closer, a complicated feedback system coordinates your body movements to maintain the balance of the ruler. The hundreds of amazing adjustments in the position of the hands always results in the same thing - a balanced meter-scale supported at its centre of gravity.

## CLOSING TIPS!



1. Can you bring the tips of two ordinary pencils together so that they touch? It is not so easy if you use both eyes. It is just about impossible if you are using only one eye. Try it.

Shut one eye. If you cannot then cover an eye with a handkerchief. Hold a pair of pencils at arm's length with your arms spread, one in each hand. Bring the pencils together quickly, aiming to touch the tips. Don't hurt yourself. Was it a hit or a miss? How many times did you try?

## WHICH WILL ROLL FASTER?

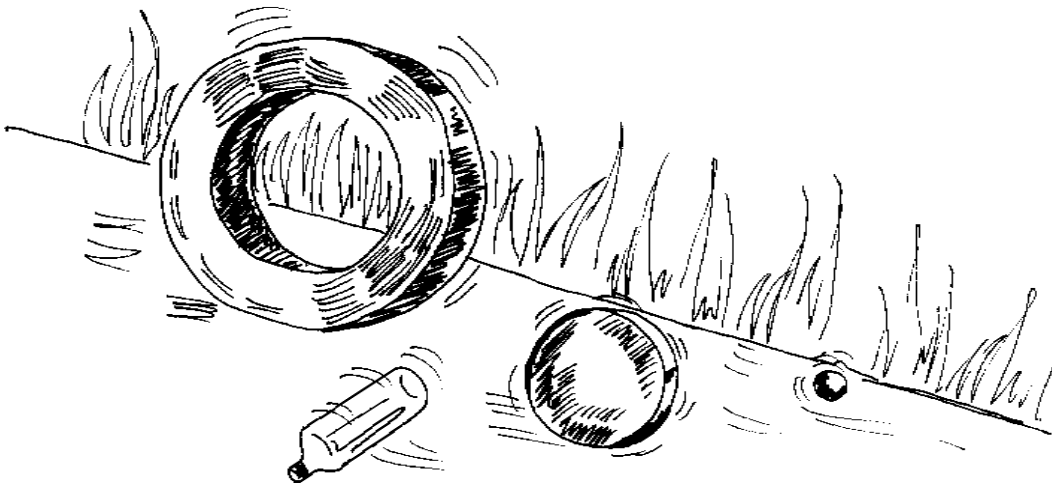

Which will roll faster - a marble, a disc or a hoop? Well, have your friends hold different objects and roll them down the same slope. You will be surprised by the findings. All spheres will beat all discs which will beat all hoops. It doesn't matter how heavy the objects are. Rolling speed is directly related to the distribution of weight around an object's centre of gravity, known as the "moment of inertia." In all three kinds of objects the centre of gravity is the geometric centre. But the weights are distributed differently. In the case of the hoop all the weight is located away from the centre of gravity. Of the three types of objects it has the largest moment of inertia. The marble has the smallest since its weight is most closely distributed around its centre. The closer the mass or weight of an object is to its centre of gravity, the smaller its moment of inertia and the faster it can rotate.

## BALLOON PUMP

With this simple pump you can actually inflate a balloon and make it POP!

1. You will need two film-reel bottles, 15-cm of old cycle tube, old refill or a stiff straw, and cello-tape.

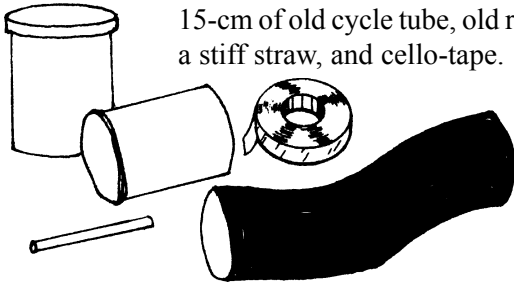

2. Make a hole in the base of film-reel bottle **A** by using a divider point. Widen this hole by gently rotating the pointed end of a scissors. The hole should be about 1-cm in diameter and should not have any burrs.

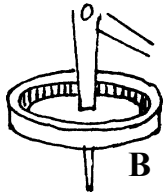
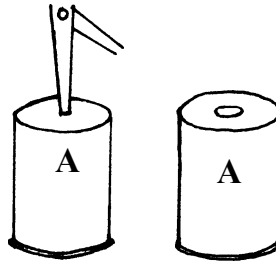

3. Make a similar hole in cap **B**.

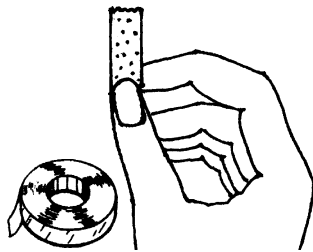

4. Take 3-cm of sticky tape. The dots show the 'sticky' side.



5. Fold 1-cm of the sticky part on itself. The lower 1-cm would still be sticky. Prepare two such tapes.



6. Stick the glue part of one tape to the cap. The tape will act like a hinge. It will open and close like a valve. This will be the **DELIVERY VALVE**.

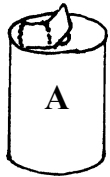

7. Paste the other tape on the base of the film-reel bottle **A**. This will be the **SUCTION VALVE**.

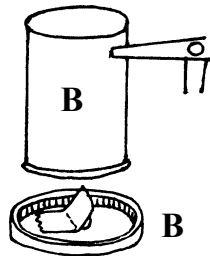

8. Take another film-reel bottle **B** and make a small hole on its cylindrical surface. Press fit a short stiff straw in it for the delivery pipe. Fix the cap with the delivery valve (Fig 6) to bottle **B**.

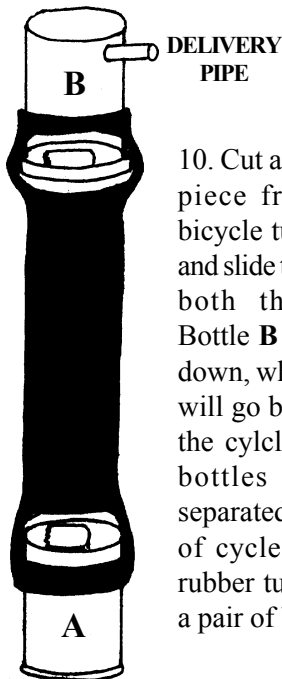

10. Cut a 15-cm long piece from an old bicycle tube. Stretch and slide the tube over both the bottles. Bottle **B** will go lid-down, while bottle **A** will go bottom-up in the cycle tube. The bottles will be separated by 7-8 cm of cycle tube. This rubber tube acts like a pair of bellows.

11. Now hold a medium size balloon in the delivery pipe. Fix it to the pipe with a rubber band to prevent any air leak. On repeatedly pumping the cycle tube by holding the two bottles, the balloon will inflate. You can "POP" a balloon with this simple pump.

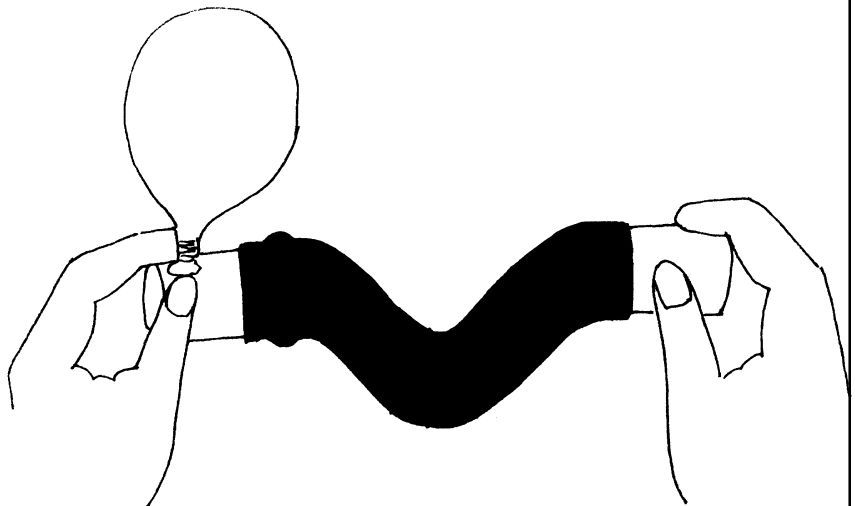



## SYRINGE PUMP

You can make a simple force pump using two plastic syringes and other common things.

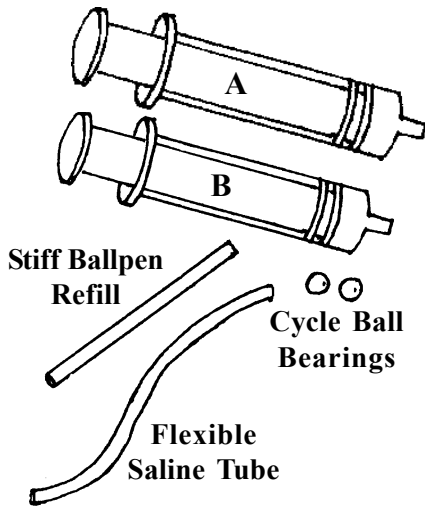

1. You will need two new 10-ml plastic syringes. Two cycle ball bearings. One stiff plastic straw, refill and a flexible tube (piece of saline tube)

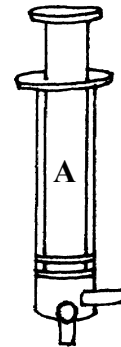

2. Remove the plunger from syringe A and insert a ball bearing. Put the plunger back. Make a small hole near the nozzle and press fit a stiff refill (you can also use M-seal or other adhesive to fix it in place.)

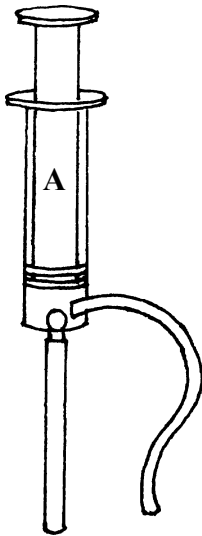

3. Press fit a 15-cm long tube in the nozzle of syringe A. This tube will vertically dip in the water well and suck the water up. Attach a flexible saline tube to the stiff refill.

4. Attach the other end of the flexible saline tube to the nozzle of the second syringe B. The second syringe B should also have a steel ball bearing in its nozzle. Make a hole near the nozzle of syringe B and press fit a refill for the delivery tube.

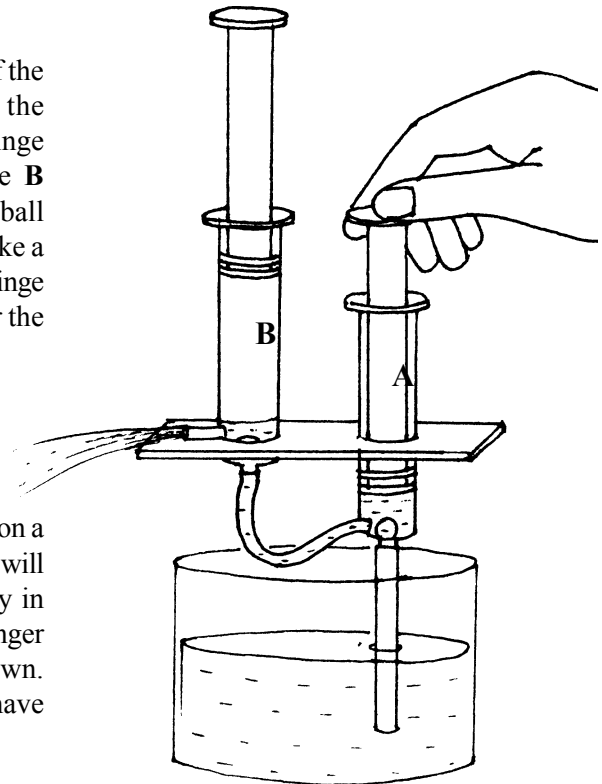

Mount both the syringes on a small wooden board. This will keep the whole assembly in place. Now move the plunger of syringe A up-and-down. After a while you will have water gushing out.

## LINKING THEM TOGETHER

These fifteen links are to be joined into one long chain. It costs one-rupee to cut a link and two-rupees to weld a link together. What would be the cheapest way to make the chain?

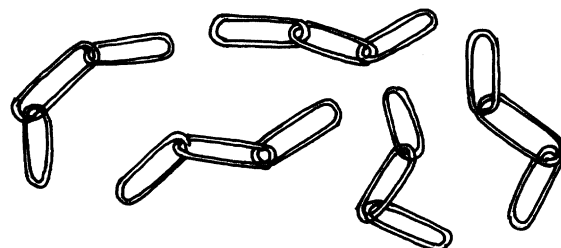

## IF SHARKS WERE PEOPLE

Schooling is all about brainwashing children into submission.

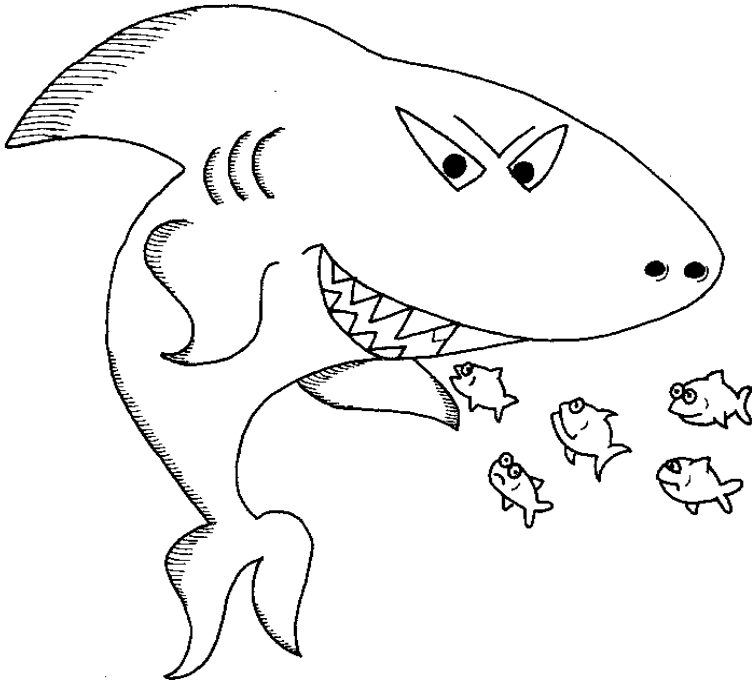

“If sharks were people,” his landlady’s little daughter asked Mr. K, “would they be nicer to the little fish?” “Of course,” he said, “if sharks were people, they would have strong boxes built in the sea for little fish. There they would put in all sorts of food plants and little animals, too. They would see to it that the boxes always had fresh water, and they would take absolutely every sort of sanitary measure. When, for example, a little fish would injure his fin, it would be immediately bandaged so that he would not die on the sharks before his time had come. In order that the little fish would never be sad, there would be big water parties from time to time; for happy fish taste better than sad ones.

Of course, there would be schools in the big boxes as well. There the little fish would learn how to swim into the mouths of the sharks.

They would need, for example, geography so

that they could find the sharks, lazing around somewhere. The main subject would naturally be the moral education of the little fish. They would be taught that the grandest, most beautiful thing is for a little fish to offer himself happily, and that they must all believe in the sharks, above all when they say that they will provide for a beautiful future. One would let the little fish know that this future is only assured when they learn obedience....

If sharks were people, there would of course be arts as well. There would be beautiful pictures of sharks’ teeth, all in magnificent colours, of their mouths and throats as pure playgrounds where one can tumble and play. The theatres on the bottom of the sea would offer plays showing heroic little fish swimming enthusiastically down the throats of the sharks.... There would certainly be religion. It would teach that true life begins in the sharks’ bellies... In short, there could only be culture in the sea if sharks were people.”

*From: KALENDERGESCHICHTEN by Bertolt Brecht*

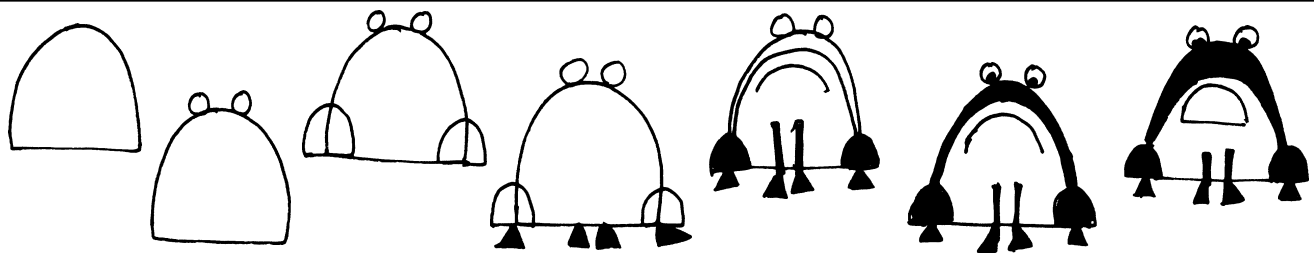
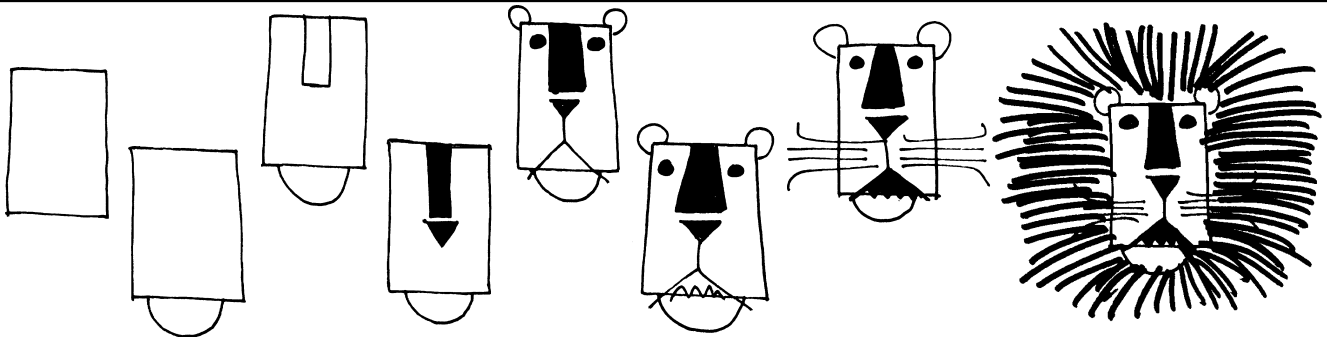

## OBSTACLE-RACE GAME

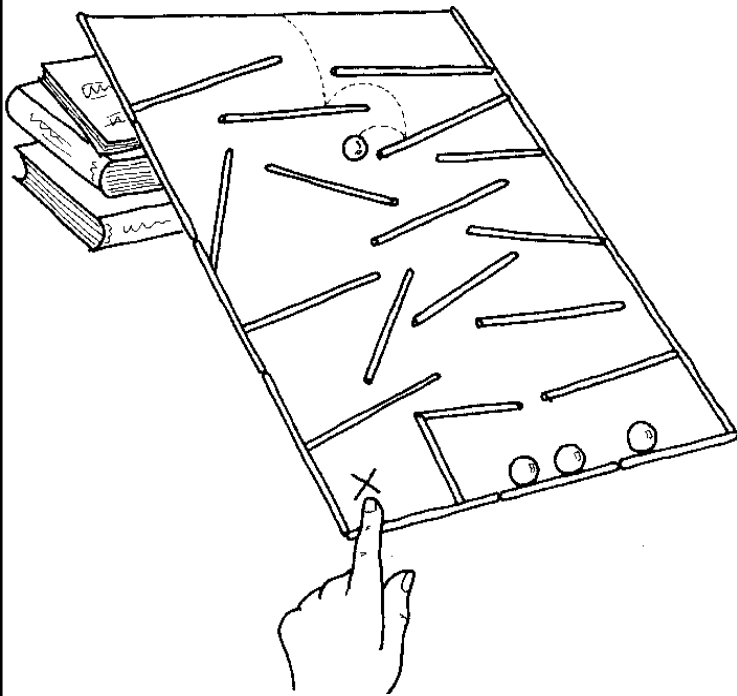

Cut a sheet of stiff cardboard into a long rectangular shape at least 75-cm in length. Glue drinking straws at the bottom of the cardboard and along the two sides.

Glue more drinking straws in a random but somewhat zigzag shape on the cardboard, taking care to leave spaces between the straws.

Glue more straws to the bottom right hand corner of the cardboard to form a box shape, with a space at the top large enough for a marble to pass through it.

Draw a small cross on the cardboard about 2.5-cm away from the bottom left-hand corner, and label it "tapping spot".

Prop the cardboard against a small pile of books or magazines until it slopes. Take care not to make the slope too steep, otherwise the marbles will roll completely over the "obstacle" straws, rather than be caught by them.

With five marbles you can start playing the obstacle-race game. The object is to roll the marbles from the top of the board into the box-shape at the bottom. Once you have released the marble you must not touch it again, and the only way you can manoeuvre it past the obstacle is by tapping the board with one finger on the "tapping spot"

## JIGSAWS

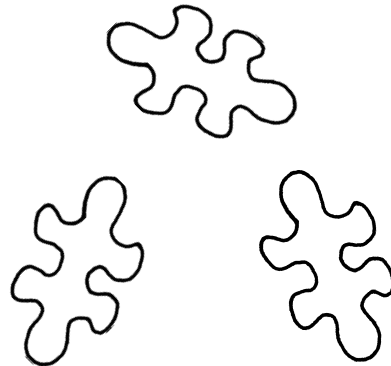
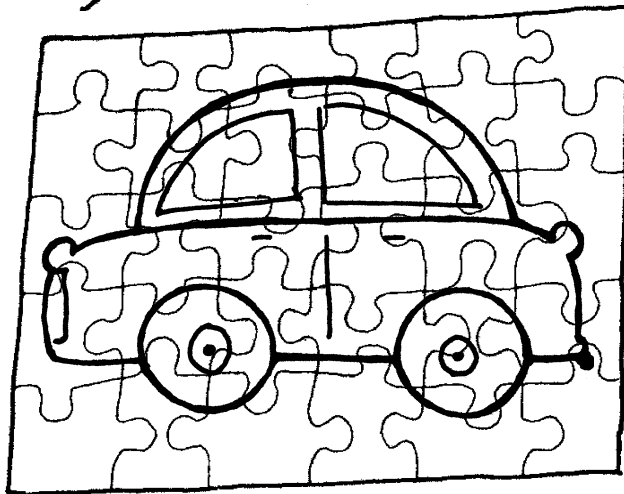
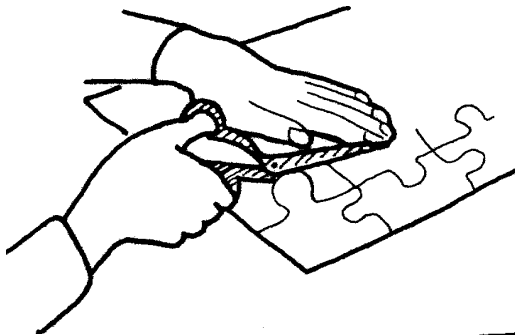

Cut out a large coloured picture from an old magazine - a picture of an animal, a car or a travel picture.

Glue the picture to a sheet of stiff cardboard.

When the picture is firmly stuck to the cardboard and the glue has dried, carefully cut the picture into a jigsaw like shape. The whole procedure is shown in the illustration. When the jigsaw has been cut out, keep all the pieces together in a plastic bag.

## CORNER BOOKMARK

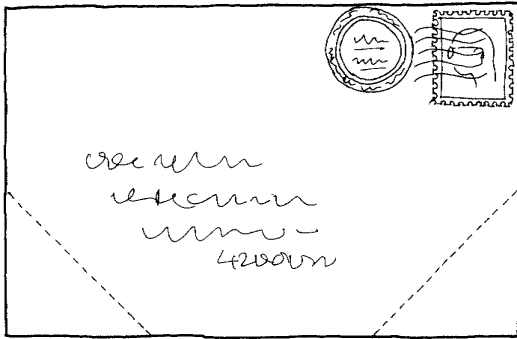

Cut the two bottom corners off an old envelope as shown in the illustration. The sides of each right angle corner should be about 4-cm long.

Draw or paint a picture or design on each corner.

Each corner now serves as a very useful bookmark if slipped over the corner of a page in a book.

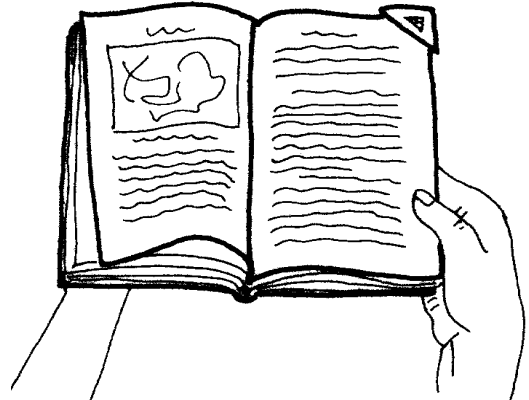
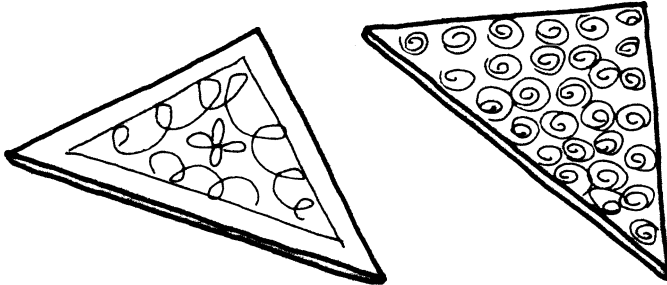

## STRING PICTURE

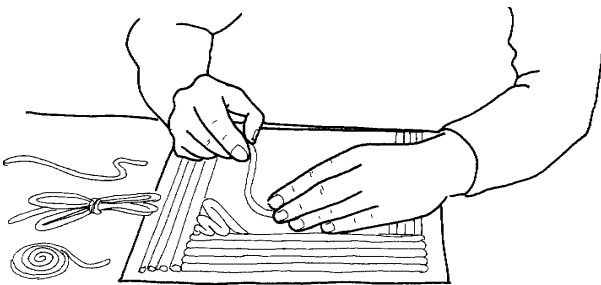

You will require different types of string, scissors, glue, sheet of cardboard for making this picture. Glue or paste different types of string on to a sheet of cardboard in order to form a pattern or picture. Push each length of string right up against another piece until the whole sheet of cardboard is covered in string, and you have your completed picture.

You can either paint the string or leave it to show its natural colouring and texture.

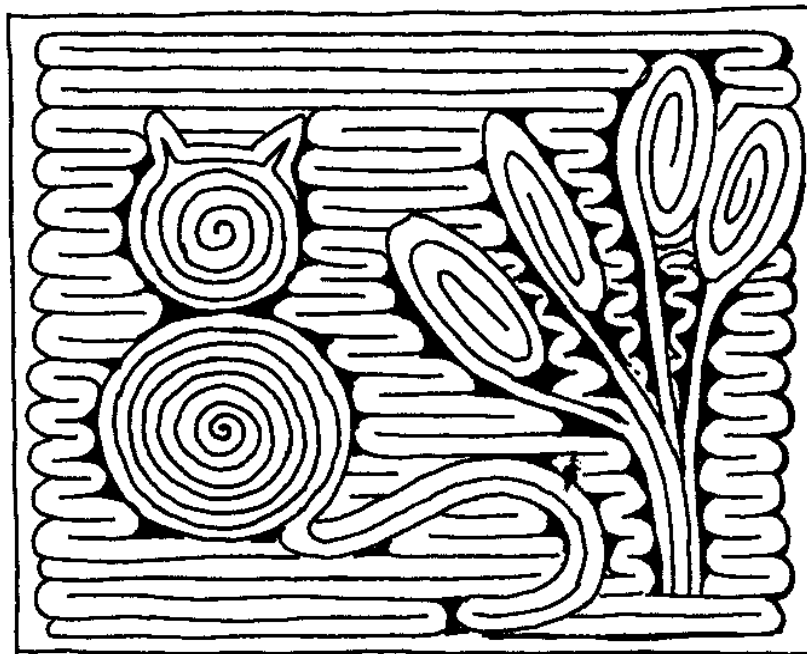

## DODECAHEDRON

The most attractive of the five Platonic solids, the dodecahedron is made of 12 pentagons.

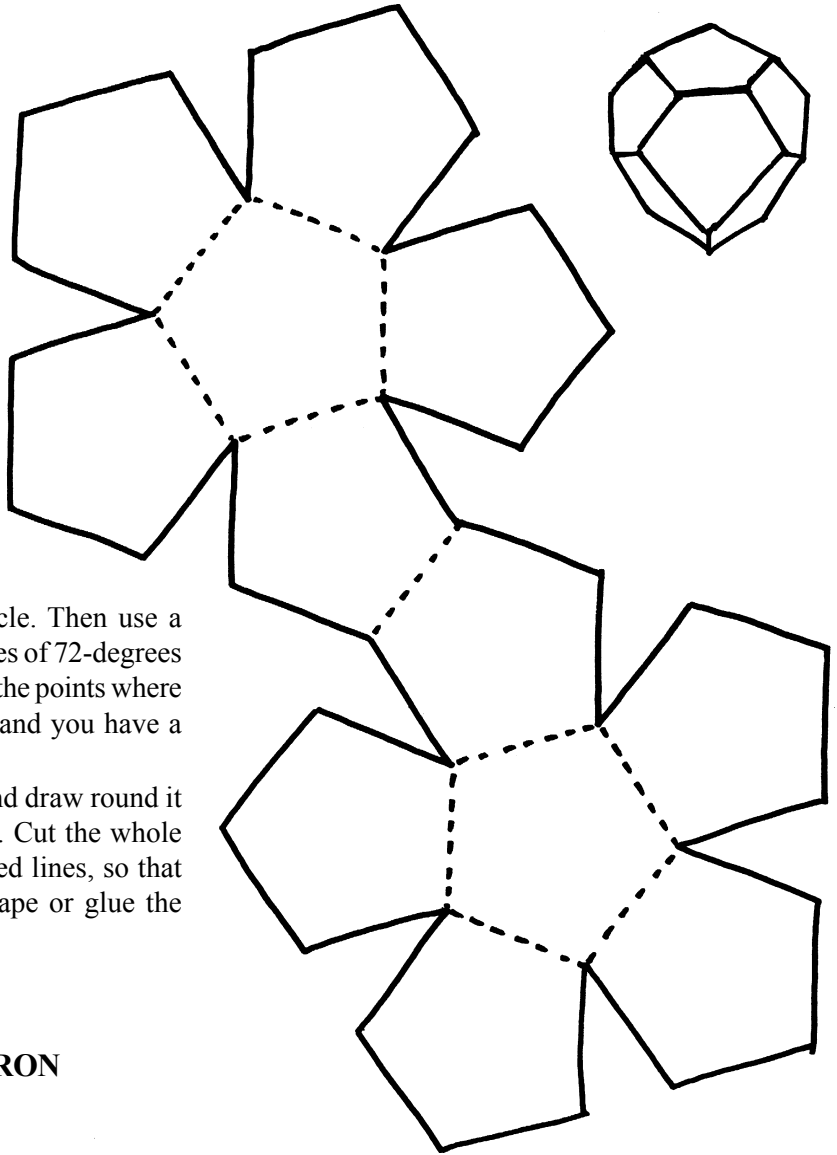
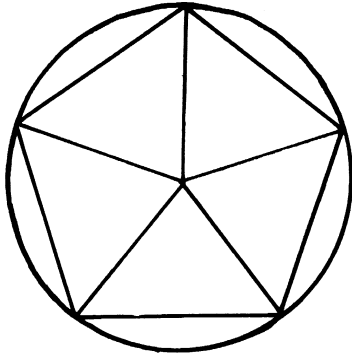

To draw a pentagon, first draw a circle. Then use a protractor to mark off five lines at angles of 72-degrees each, from the centre of the circle. Join the points where the lines touch the edge of the circle and you have a pentagon.

Make a card template of a pentagon and draw round it to make the network of 12 pentagons. Cut the whole thing out as one piece. Score the dotted lines, so that the dodecahedron is easier to fold. Tape or glue the edges together.

### A POP-UP DODECAHEDRON

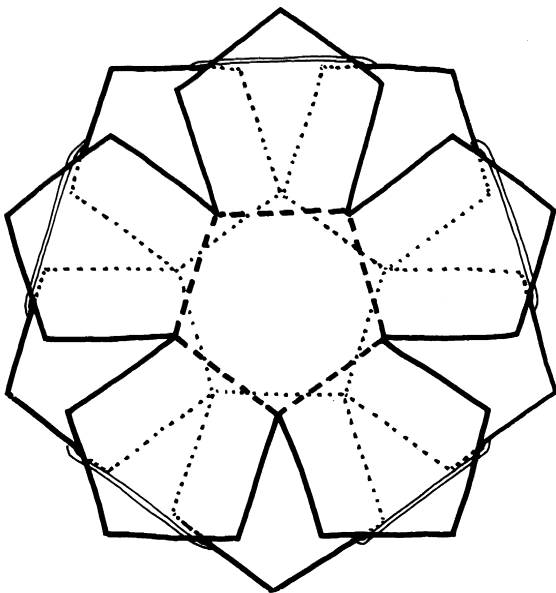

Draw and cut out the two nets. Score and fold inwards along the edges of the inner pentagons. Place the two face-to-face so that the bends face inwards and the points overlap. Now weave an elastic band around the points, passing over and under. When you release it the dodecahedron will spring into shape. For this figure, the stiffer the card the better. Since it has twelve sides it makes a good desk calendar.

## SQUARE FLEXAGONS

Square flexagons are simple to make. You need to cut a network of six squares and colour them on both sides.

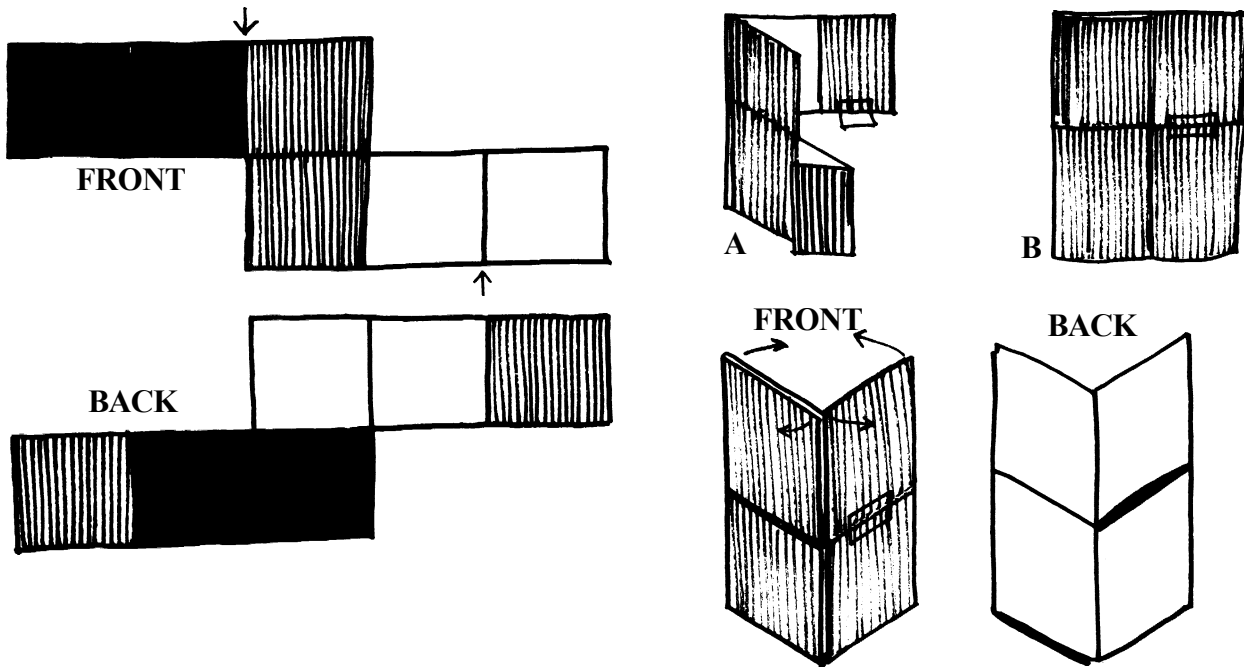

Fold up the square A and tape the open edge with cello tape B. There will be one colour on the front, another colour on the back and a third hidden inside. To flex, gently fold the square away from you and open it out from the centre. One colour will vanish and another will come to the front. You could make a picture frame like this, to show three different pictures, according to your wish.

## FOLDING CUBES

This toy can be made by attaching four cubes to a square flexagon.

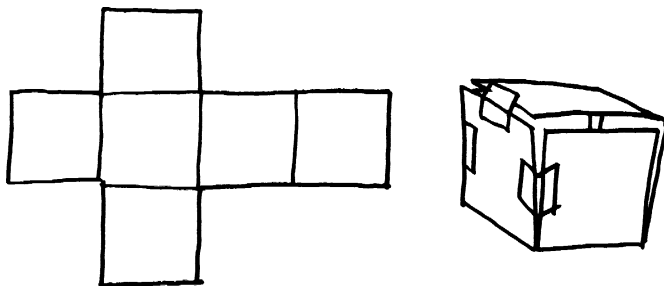

1. This is the net for the cube.

2. One face of the cube never goes inside. Glue the four cubes to that face. You will find that you can flex the cubes just like the strip, but also you can fold them across the normal hinge directions. This is how the movement will work. The spots show the way the cubes rotate.

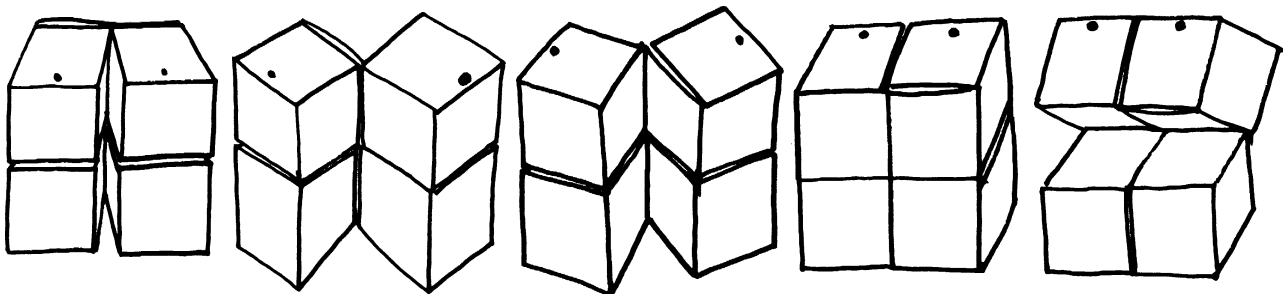

# MATHS TEASERS

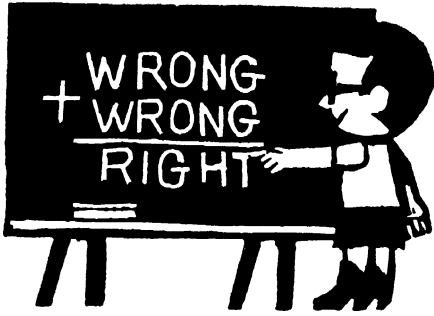

1. Show that two WRONG's can make a RIGHT, even with the additional restriction that 0 = zero

2. Using mathematical symbols to modify four fours it is possible to write expressions for all the numbers from 0 to 100, as well as millions of others. Example:  $2 = 4/4 + 4/4$ . In this manner arrange four fours to equal these progressively more difficult numbers: 13, 19, 33, 85. Apart from operations of addition, subtraction, multiplication and division you can use square roots, factorials and other mathematical operations too.



3. Arrange the digits 0 to 9 in fractional form so that:  $\frac{xx,xxx}{xx,xxx} = 9$

Some possible solutions are given below:

$$\frac{97,534}{10,836} = 9 \quad \frac{75,294}{08,361} = 9 \quad \frac{57,429}{06,381} = 9$$

$$\frac{58,239}{06,471} = 9 \quad \frac{95,742}{10,638} = 9 \quad \frac{95,823}{10,647} = 9$$

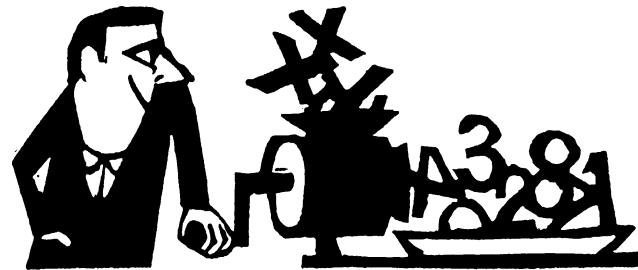

4. There are five weights, no two weighing the same. With a beam balance, arrange the weights in order from heaviest to lightest in seven weightings.

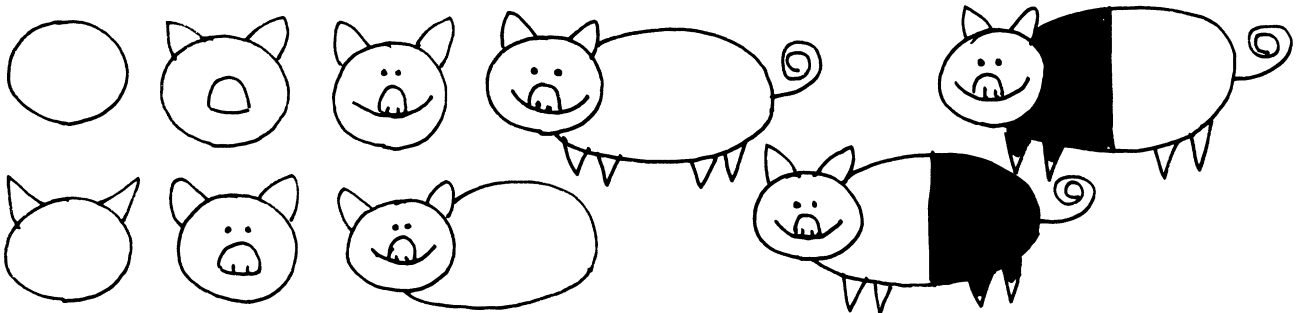
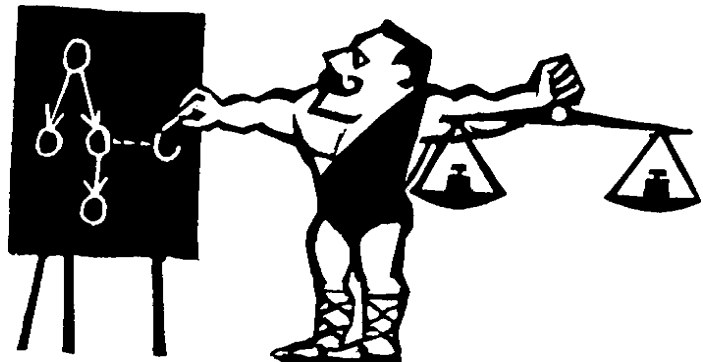

## BALANCING DRAGONFLY

Cut out the body and the wings of the dragonfly using thick card sheet (tetrapacks are ideal). Then stick the wings to the body. Bend the triangular head of the dragonfly at right angles and perch it on a stand. Bend the wings a little to balance the dragonfly. If the assembly is kept under a fan the dragonfly will keep going round-and-round in circles on its tip.

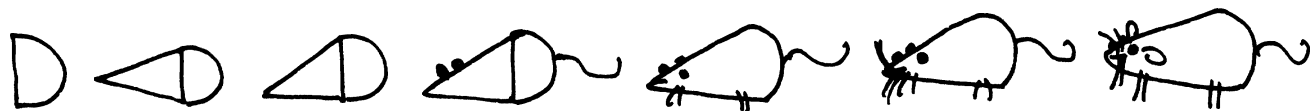
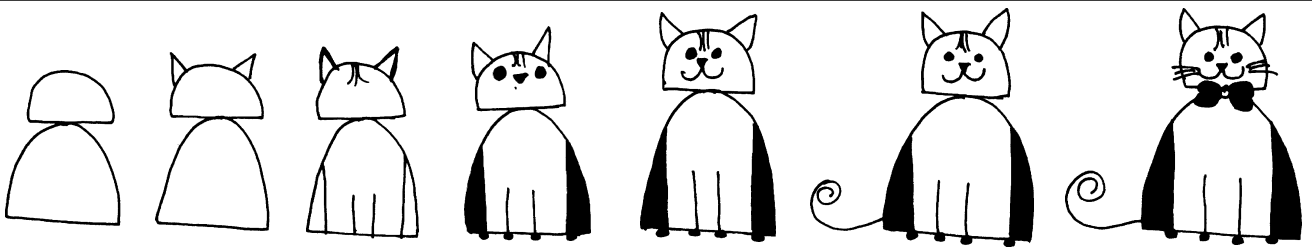
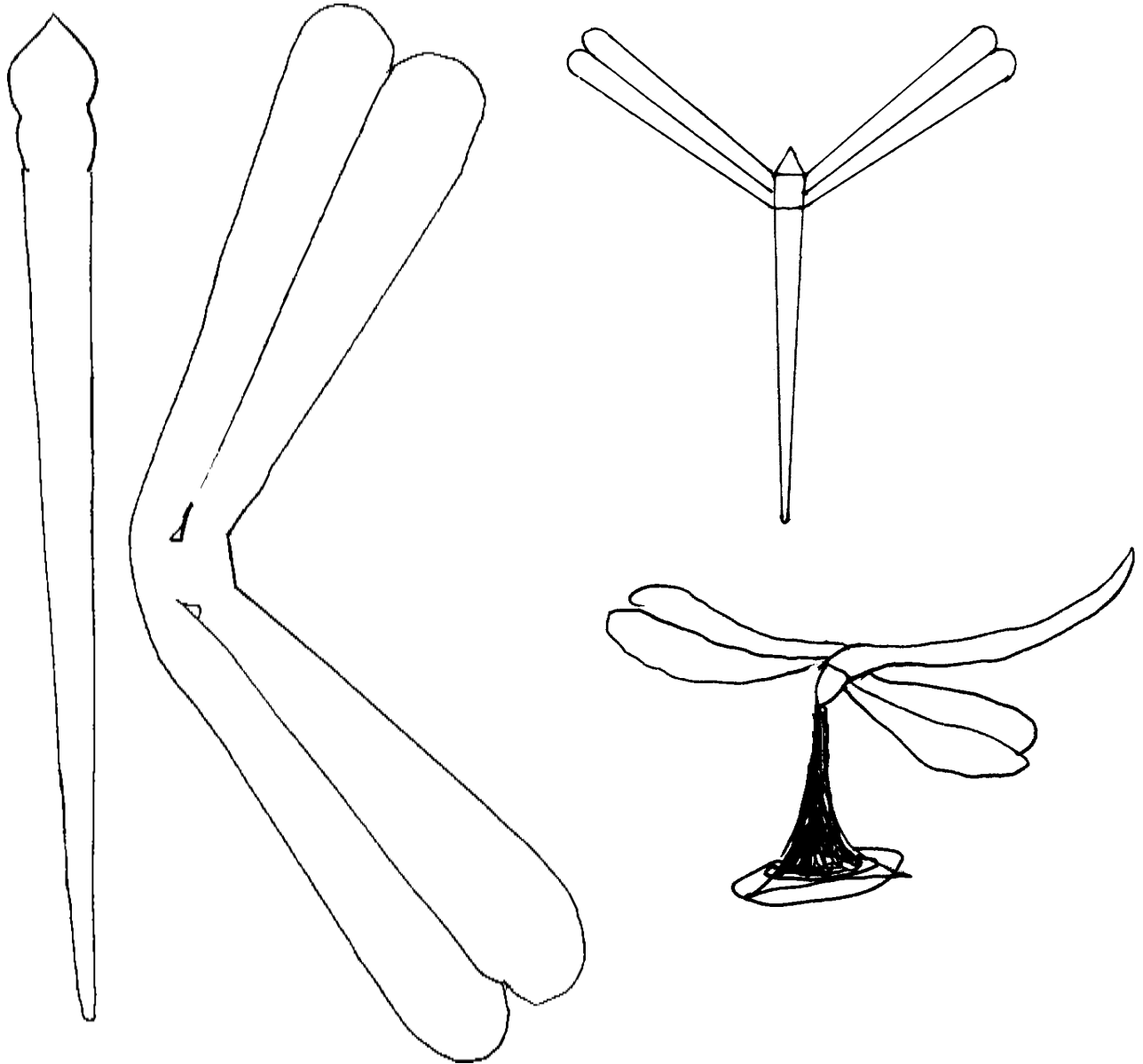



## DANCING FALL

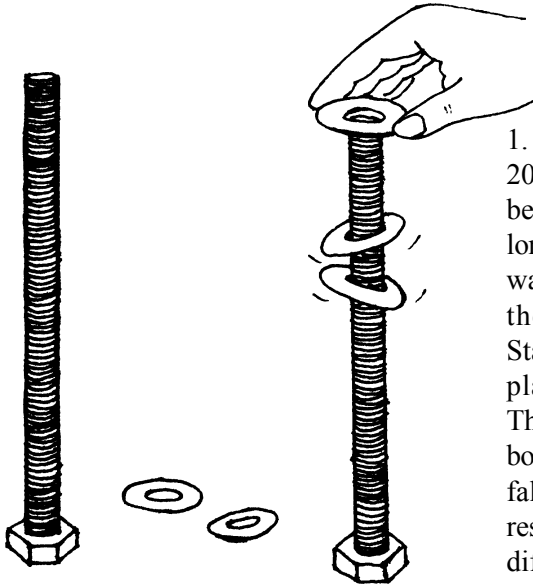

1. Take a 8-10mm diameter 20-cm long steel bolt. It will be very nice if you can get a long stud. Also get a few steel washers slightly larger than the diameter of the bolt. Stand the bolt vertically and place the washers on top. The washers will go down the bolt in a very funny "dancing" fall. For the most spectacular result you'll have to try a few different sizes of washers.

## HOW MUCH IS A NEWTON?

Most people have little feel of it.

People have some feel for distance, time, weight, volume, area etc. But when it comes to estimating force, people have no clue. Our "feel" or "estimate" for force is often very off the mark. Give someone a kitchen scale and ask him to show the force of 1-newton.

Most likely the person will show something much more. For most practical purposes we can round off the value of  $g$  to  $10\text{-m/s}^2$ , which means that the weight of 1-kilogram is 10-newtons. Thus the force of 1-newton (1-N) can be simply shown by putting a 100-gm weight on the kitchen balance.

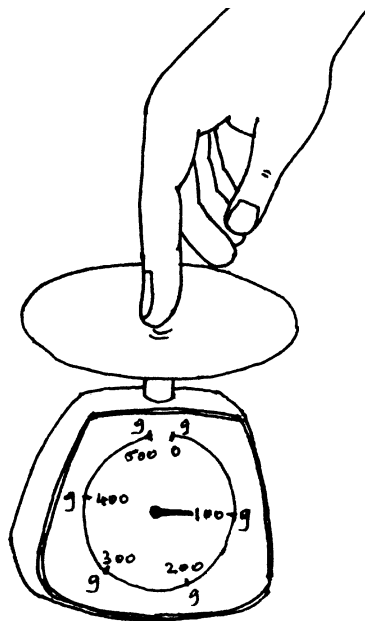

## FORCEFUL FALL

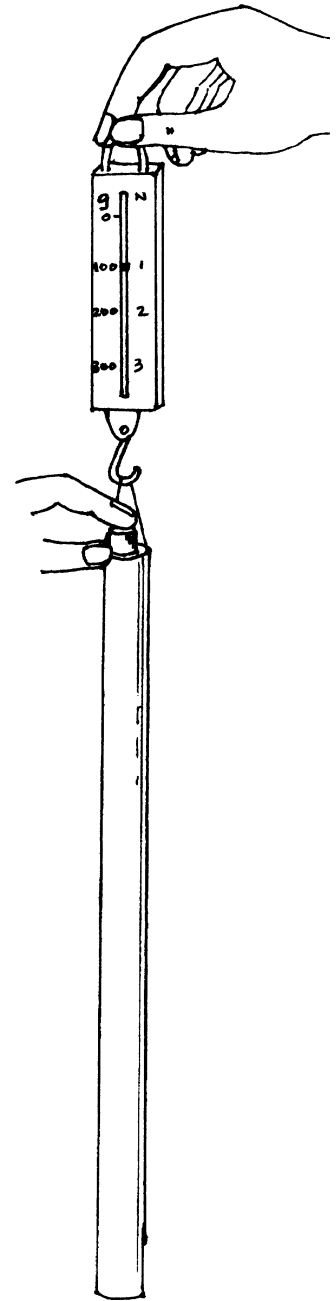

Take a long aluminium tube and hang it by a spring balance. Note the reading of the balance. Now take a strong cylindrical magnet (less than the diameter of the tube) and drop it in the aluminium tube. The balance will register an increase. The magnet creates eddy currents in the tube which retard the fall of the magnet. This results in a downward force exerted by the magnet.

## SWINGING ACROBAT

You will need: two empty matchboxes two wood batten, about 2 x 25-cm string, scissors, nail, glue, sticky tape, pencil, ruler and colouring materials.

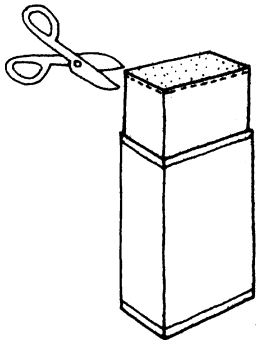

1. Push part of one matchbox tray from its casing and cut away the end.

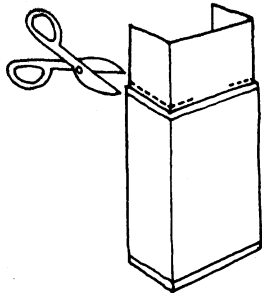

2. Cut into the sides of the tray, above the edge of the casing.

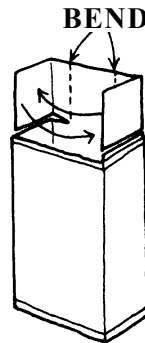

3. Bend the bottom of the tray as shown, so that the side flaps overlap....

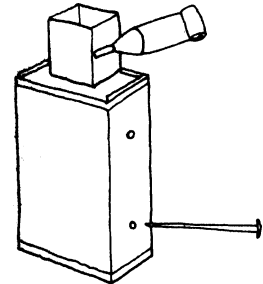

4 ....and fasten them together with a spot of glue. This forms the acrobat's head. Now make two holes in each side of the box with a nail.

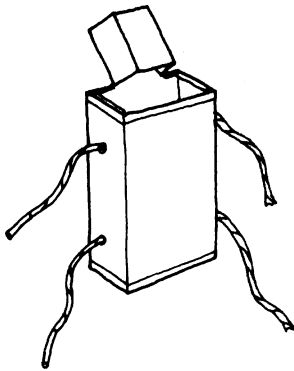

5. Cut two pieces of string at least 12-cm long. Neatly wrap a small piece of sticky tape around one end of each (to stop the ends from fraying), and thread one through the top two holes and one through the bottom two holes.

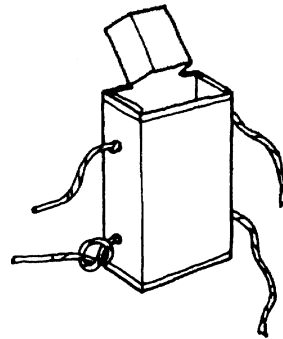

6. Tie a knot in each protruding end, close to the side of the box.

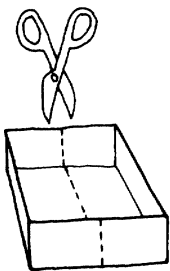

7. Take the tray from the other empty matchbox and cut it in half lengthways.

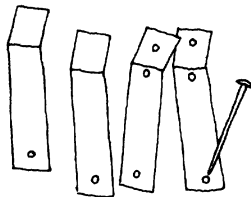

8. Then cut each half as shown to make four similar pieces.

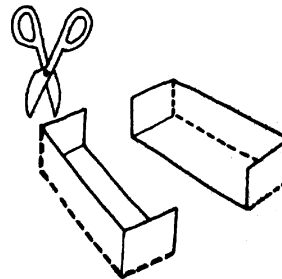

9. These will become the acrobat's arms and legs. Pierce a hole in one end of each as shown. In two of the pieces, pierce another two holes, 1-cm apart, at the other end.

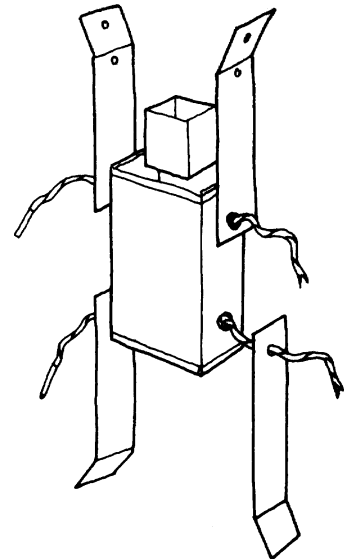

10. Slip the arms and legs on to the string ends. Tie a knot in each string close to the arm or leg....

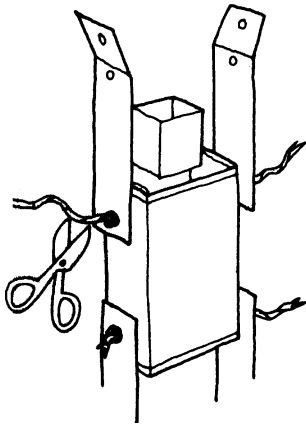

11.... and cut off any surplus.

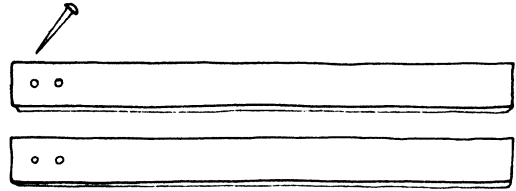

12. Prepare the handles by piercing two holes, 1-cm apart, in one end of each of your battens.

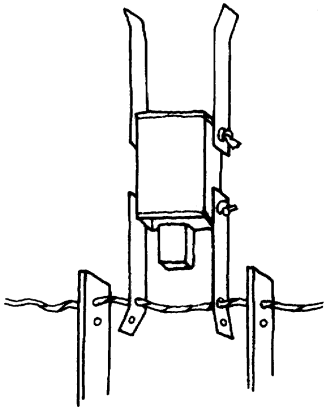

13. Place the acrobat on a table, head down, between the two handles as shown. Take a piece of string, about 20-cm long, and wrap sticky tape around one end. Thread this end through the uppermost holes in the handles and arms....

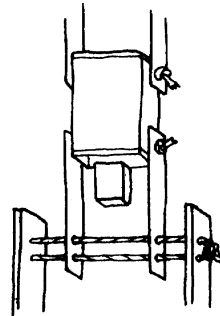

14.... then take the string back through the lower holes and tie a knot to complete the loop. Cut off any surplus string.

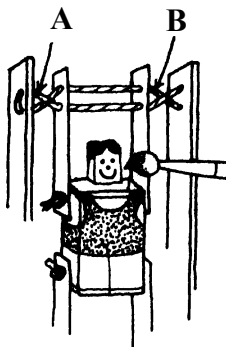

15. Bring down the acrobat to lie between the handles. Draw in the face and perhaps a colourful costume.

16. Pull the two handles apart and the acrobat should swing up and around with his legs flying.

**IMPORTANT:** Before using this toy make sure the strings are crossed at points A and B as in fig 15. Sometimes the strings become twisted, or crossed the wrong way, and this prevents the toy from working properly.

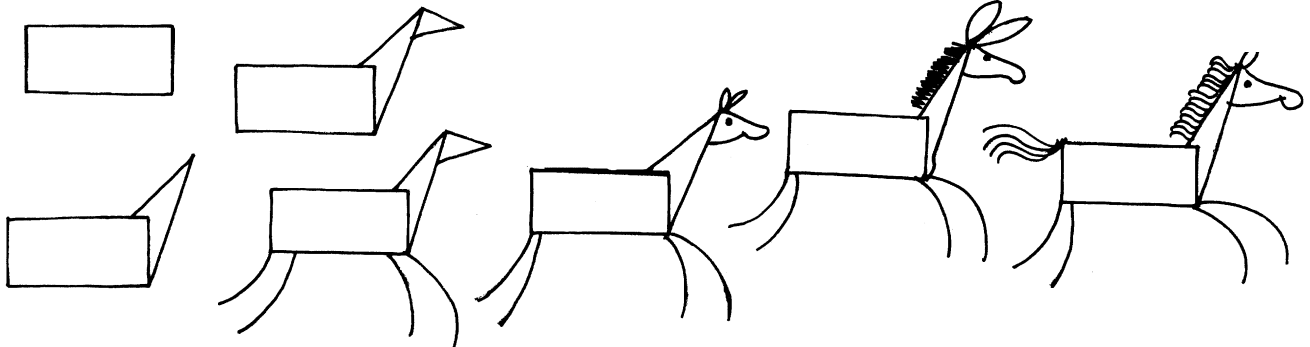
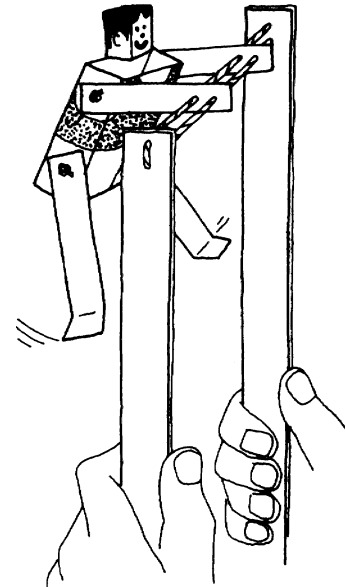

## MATHEMATICAL PROOF VERSUS SCIENTIFIC PROOF

Whereas science is based on experimental proof, mathematics is built on infallible logic

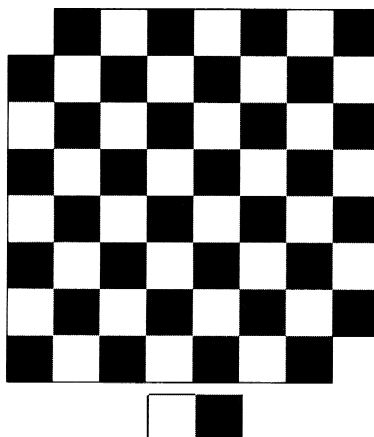

Science is based on a judicial system. A theory is accepted as true when enough experimental evidence proves it 'beyond all reasonable doubt'. Mathematics on the other hand does not at all rely on experimentation. Because experiments can sometimes fail. The foundations of mathematics are built on infallible logic. The problem of the Mutilated Chessboard beautifully illustrates the difference between a scientific and mathematical proof.

In the above chessboard two opposite corners have been removed. Thus instead of 64 squares, only 62 squares remain. We have 31 dominoes (two tandem squares). The question is: is it possible to arrange the 31 dominoes so that they cover all the 62 squares on the chessboard? The problem can be solved scientifically or mathematically.

(1) **Scientific Method:** The scientist would try to solve the problem experimentally. He will try out various possible combinations to fill up the chessboard with 31 dominoes. He would soon discover that all his efforts fail. Soon he may gather enough evidence to conclude that it is impossible to cover the board. But how can the scientist be dead sure about his claim? He tried out several combinations which did not work. But there are millions of ways of tiling the board with 31 dominoes. And he has not tried, nor possibly can try them all. Some of the combinations which he did not try out might actually work. Who knows? The scientist's conclusion that the puzzle is an impossibility is based on experiment. There is a nagging possibility that someday someone may discover the right combination and overturn the scientific theory.

(2) **Mathematical Method:** The mathematician tries to answer the question by developing a logical argument. He will try to derive a sure shot correct conclusion which will remain unchallenged forever. Sample such an argument:

- As the corners which were removed from the chessboard were both white, so there will now be 32 black and only 30 white squares left.
- Each domino can cover only two neighbouring squares. And neighbouring squares are always different in colour - one black and one white.
- Therefore, no matter how they are arranged, the first 30 dominoes laid on the board will cover only 30 white squares and 30 black squares.
- Consequently, this will always leave you with one domino and two black squares remaining.
- But remember all dominoes cover two neighbouring squares, and neighbouring squares are opposite in colour. However, the two squares remaining are the same colour and so they cannot both be covered by the one remaining domino. Therefore, covering the board is impossible! This proof shows that every possible arrangement of dominoes will fail to cover the mutilated chessboard.

Thereafter the mathematician can live and later die in peace!

From: *FERMAT'S LAST THEOREM* - Simon Singh

## BOXERS

You will need: thick card or soft wood, thin card, craft knife, nail, string, pencil, ruler and sketch pens.

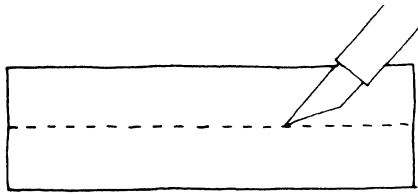

1. Cut the thick card or balsa wood into two 3 x 20-cm strips.



2. Prepare two 3 x 15-cm strips of thin card. Draw a simple side-view of a man on each, filling up as much of the space as you can, and cut them out.

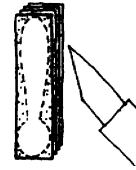

3. Prepare four 1.5 x 6-cm strips of thin card and draw the shape of an arm, with boxing glove, on each. Cut them out.

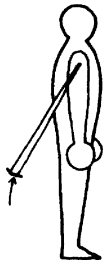

4. Place a cut-out arm on each side of one man and use the nail to pierce a hole through both the arms and body.

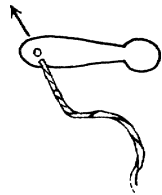

5. Wrap a piece of sticky tape around one end of the string and thread it through the hole in one of the arms.

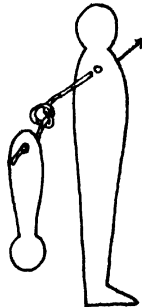

6. Tie knots in the string close to the arm on either side. Thread the string through the body and tie another knot. Thread through the other arm and tie a final knot.

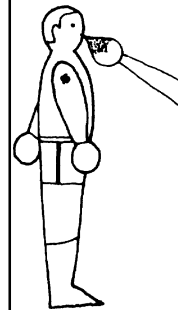

7. Make sure the arms swing freely and then trim off the surplus string. Draw and colour the man to make him look like a boxer. Repeat steps 4 -7 with the other pieces.

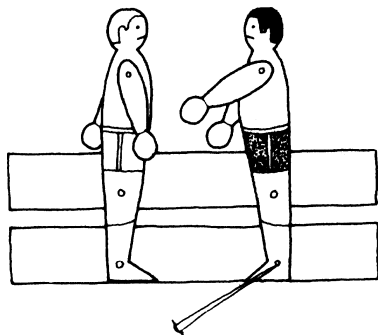

8. Place the two strips of thick card or soft wood on a flat surface 1-cm apart, one above the other. Place the two boxers on these strips, 5-cm from the left and right edges. Make sure that they face each other and that their feet rest on the bottom edge. Pierce holes through their ankles and thighs and the supporting strips behind. These should be about 1-cm above the lower edge of each strip.

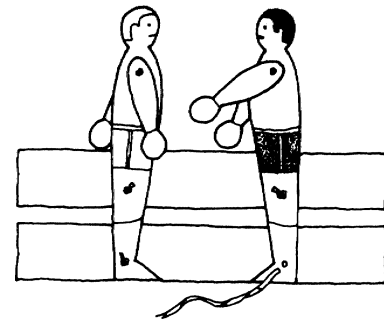

9. Join the boxers to the supporting strips by threading string through each of the holes and tying knots in front and behind. Trim off the surplus string.

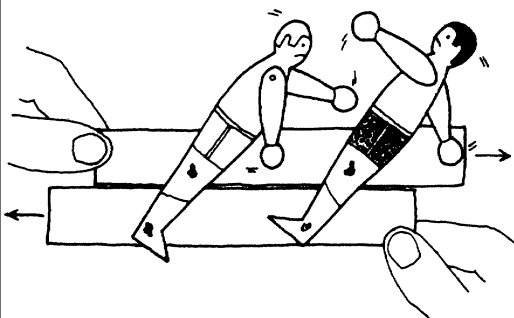

10. Hold the strips at either end, and move them from side to side. The boxers will fight with their arms swinging.

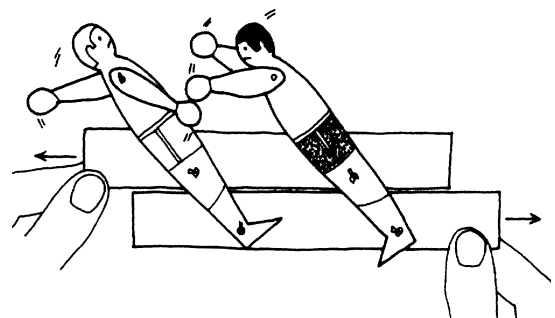

## BUZZ SAW

The Buzz Saw is a sound toy. It has been made and played with for hundreds of years.

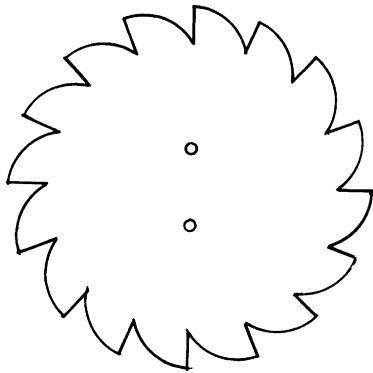

1. Draw a circle with teeth approximately 7-cm in diameter on a piece of cardboard. You can use the bottom of a glass to make the circle.

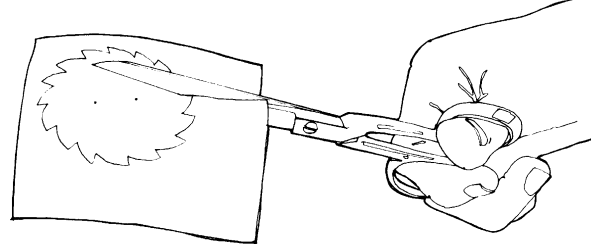

2. Then cut the circle carefully. Be sure to cut the teeth along the edge of the disc as shown in the pattern.

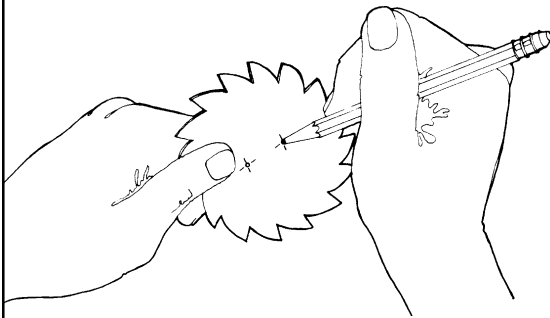

3. Now punch two holes roughly 1-cm apart from the centre of the disc. You can make the holes with the tip of a sharp pencil.

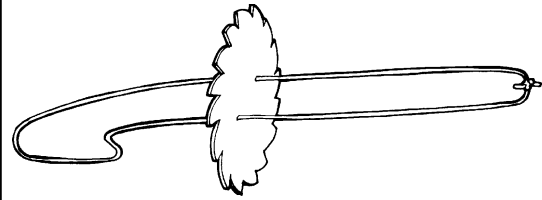

4. Thread a piece of string through the two holes as shown above. Tie the ends together in a knot.

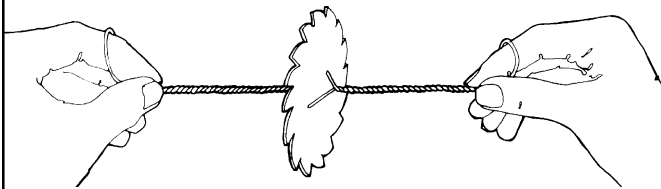

5. Wind up the Buzz Saw by swinging it over and over in the middle of the loops, holding the ends of the strings with your fingers. Place a piece of stiff paper on a table so that juts out from the table edge. Hold the paper in place with a book. Now spin the Buzz Saw and bring its teeth into contact with the paper. The tops of the teeth the paper will create a shrill noise.

## CARDSHEET BIRD

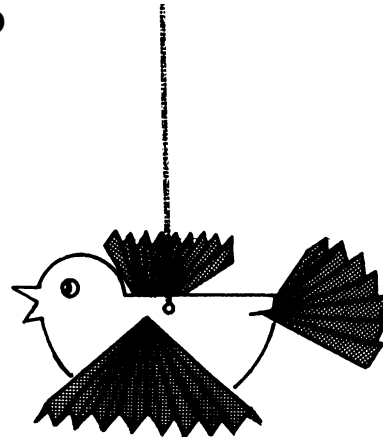
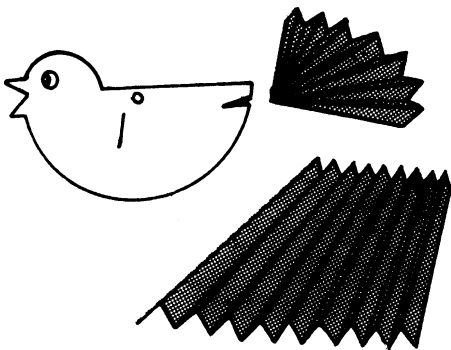

Cut out the body and head of the bird from cardboard. Colour both sides of the body with crayons. Paint the eyes with bright colours. Cut a slit through the body near the shoulders for the wings. Make another small slit at the rear for the tail to be slipped and glued in position. Fold coloured paper in an accordion shape to make the wings. Tuck the wings and glue the tail. Then hang the bird with a thin string.

Courtesy : *LOW-COST EDUCATIONAL MATERIALS UNESCO*

## COCONUT CRAFT

Coconut craft uses the leaves of the coconut palm. We can make a variety of birds, insects, animals with them. Strips of palm leaves can produce numerous toys of extraordinary simplicity and beauty.

### SWALLOW

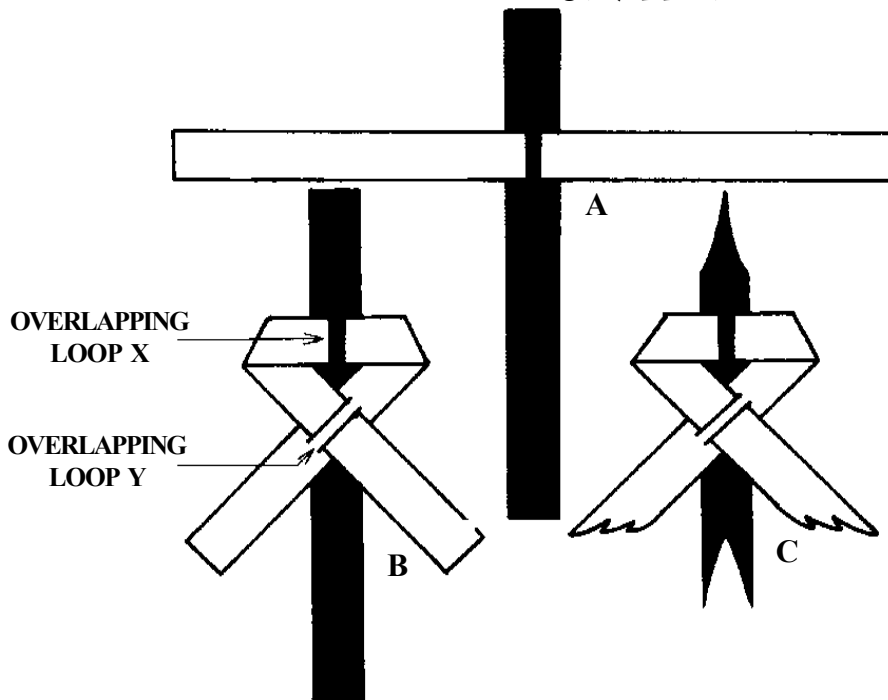

1. Take two strips of palm leaf (without the midrib) of almost equal width and then do as shown.

2. Cut the shape of the wings and tail using a pair of scissor. Overlapping loop strips 'X' and 'Y' could be simply torn using finger pressure (however the length of the 'loop' should be no longer than the width of the strip that passes through it).

### WINDMILL

Take two strips of palm leaf each about 20-cm long and 2-cm wide. Follow the steps to complete the windmill.

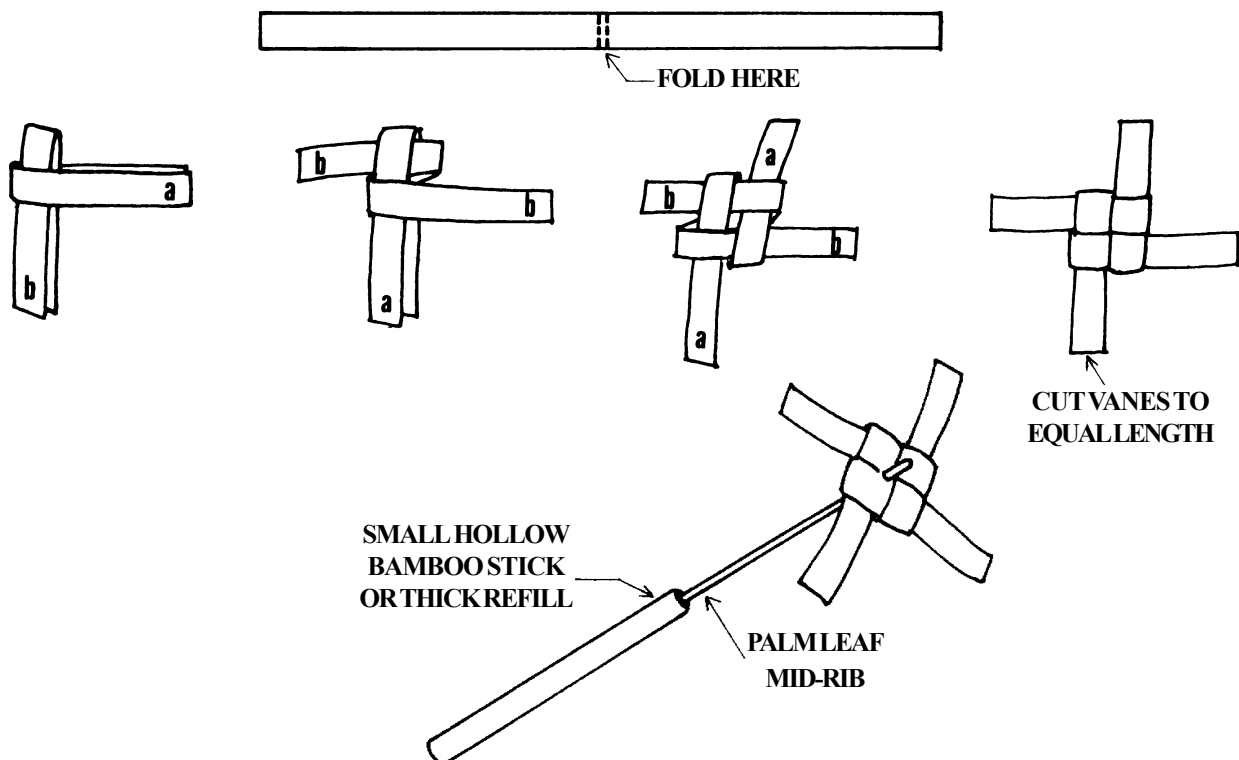

## JUMPING JACK

It is easy to make, and great fun to play.

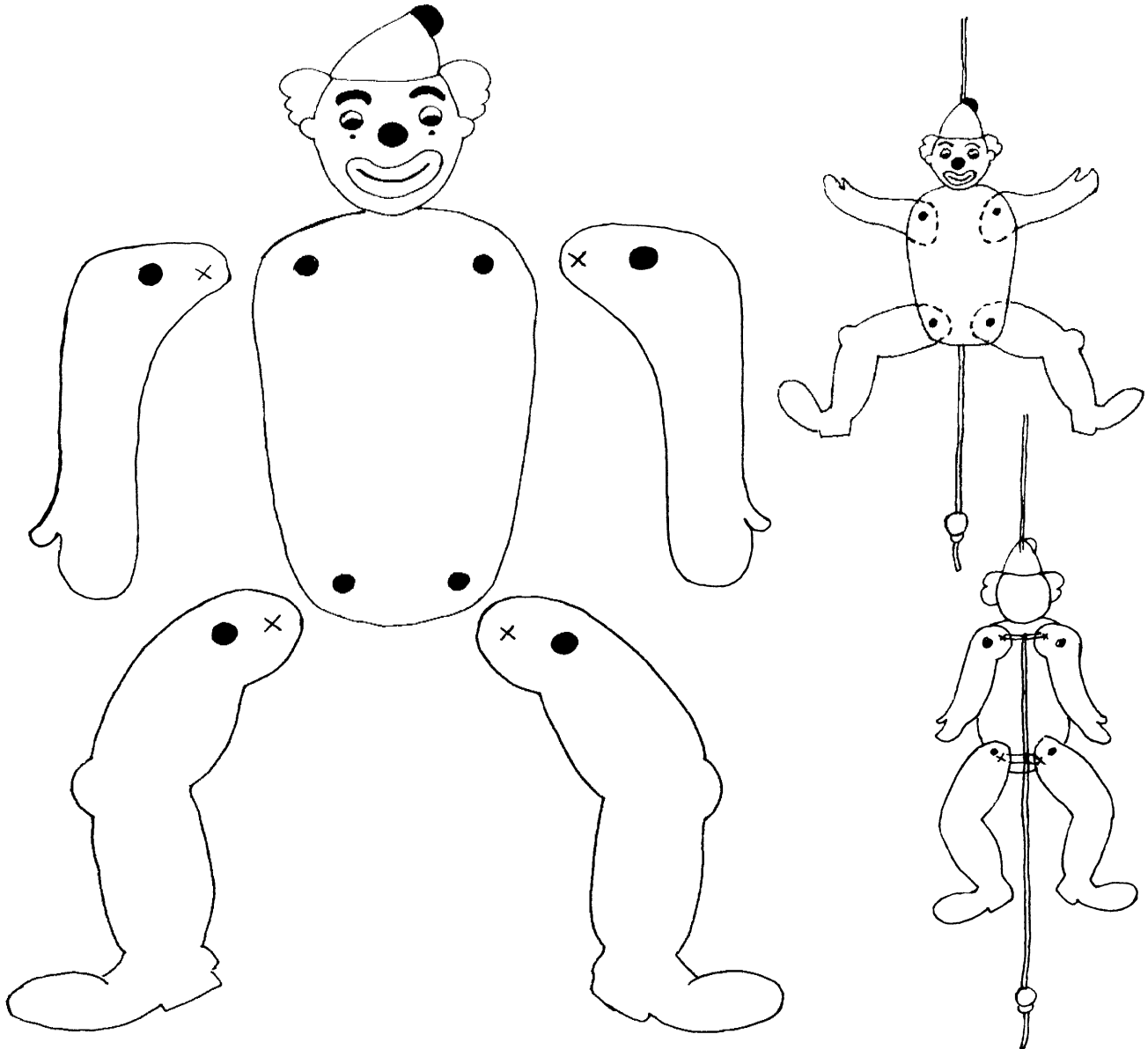

Copy or trace the picture on a paper and then stick it on cardboard. After the glue has dried cut out the body parts with scissors. Pierce a hole at the black dots with a nail and X's with a divider point. Attach each arm and leg to the body by inserting a split paper pin (available in stationary stores), or else make a thread hinge by tying knots on both sides of the figure. The arms and legs should move smoothly around the hinges.

Connect the arms by threading a short piece of thin string through the holes at the X's. Connect the legs in the same way. The string between the legs and the arms should not sag. Attach a string through the hole in the top of the head. Use another string to tie the arm and leg strings together, allowing about 30-cm of string to hang from the bottom. Decorate the Jumping Jack with sketch pens and colour pencils.

To make the Jack jump, hang the top loop of thread by a wall nail. Now gently pull the string hanging from the body. The arms and the legs will fly up in the air. On releasing the string the arms and legs will return to the original position.



## DANCING ELEPHANT

This variation of the Jumping Jack is endlessly fascinating.

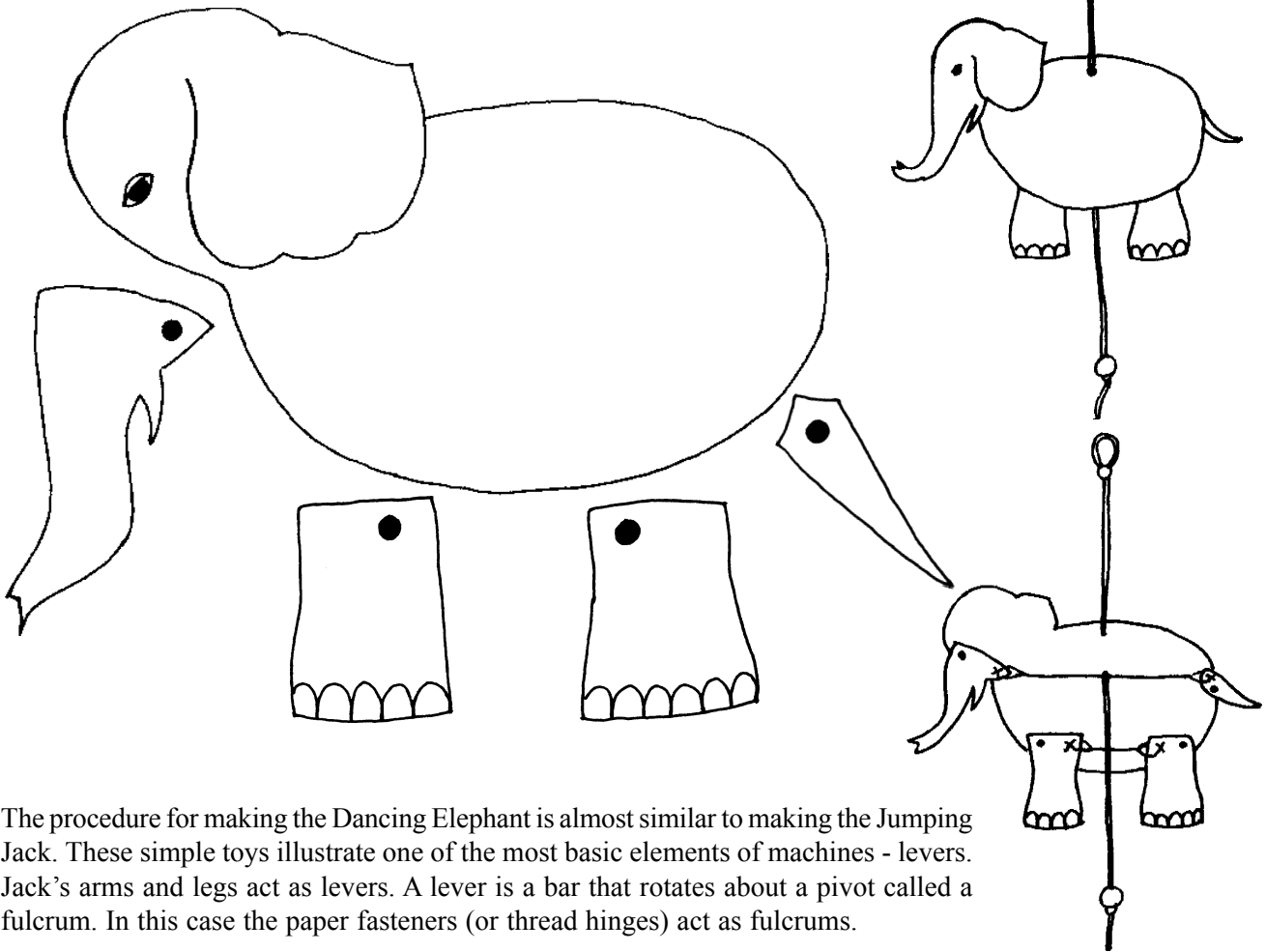

The procedure for making the Dancing Elephant is almost similar to making the Jumping Jack. These simple toys illustrate one of the most basic elements of machines - levers. Jack's arms and legs act as levers. A lever is a bar that rotates about a pivot called a fulcrum. In this case the paper fasteners (or thread hinges) act as fulcrums.

The lever arrangement also changes the straight-line motion of the string into circular motion. More importantly, it multiplies the small movement of the applied force to create a large movement of the hands and feet. Using your imagination create your own designs.

## MATHEMATICAL RIGOUR

This story told by Ian Stewart clearly highlights the rigour in mathematics.

An astronomer, a physicist, and a mathematician (it is said) were holidaying in Scotland. Glancing from a train window, they observed a black sheep in the middle of a field. 'How interesting,' observed the astronomer, 'all Scottish sheep are black!' To which the physicist responded, 'No, no! Some Scottish sheep are black!' The mathematician gazed heavenward in supplication, and then intoned, 'In Scotland there exists at least one field, containing at least one sheep, at least one side of which is black.'

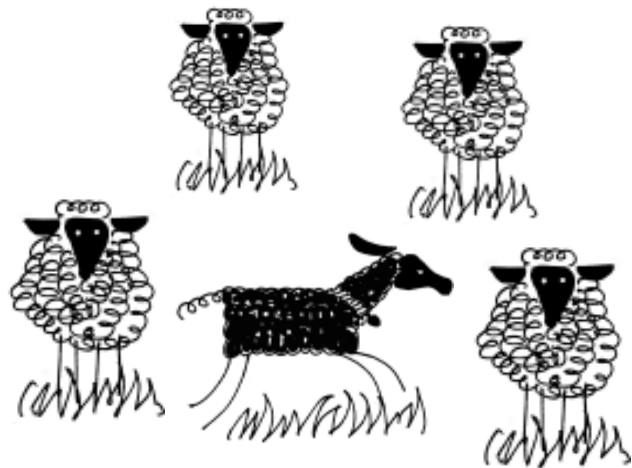

# ABC PICTURES

Find the alphabets in the pictures. Make some on your own.

**A**

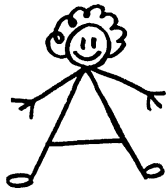

**B**

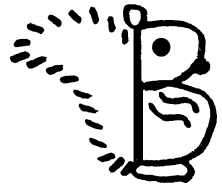
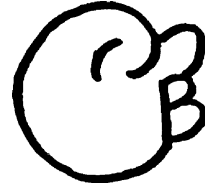
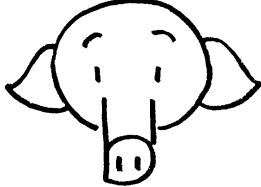
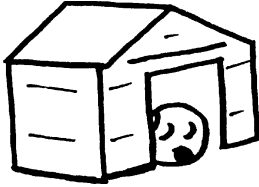

**C**

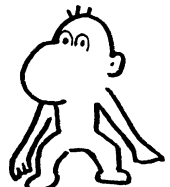

**D**

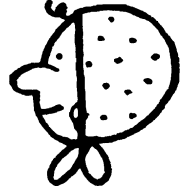
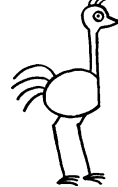
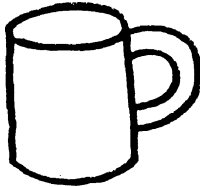

**E**

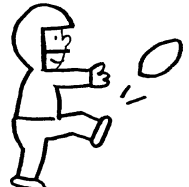
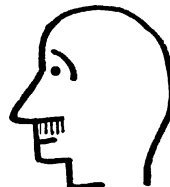

**F**

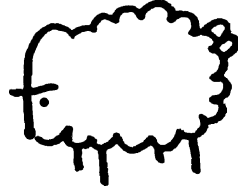
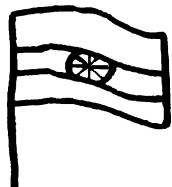
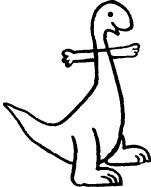

**G**



**H**



I



J

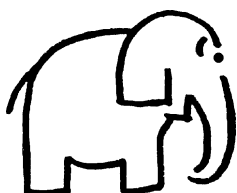
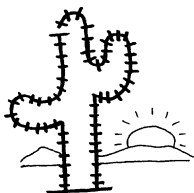

K

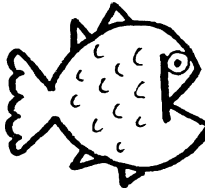
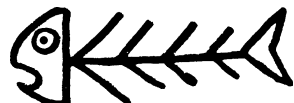

L

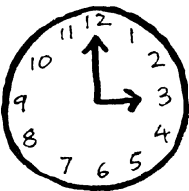
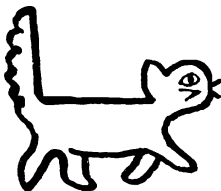

M

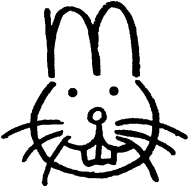
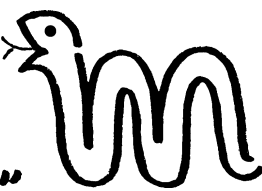

N

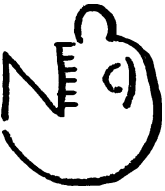

O

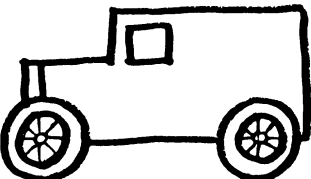

P

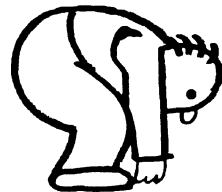
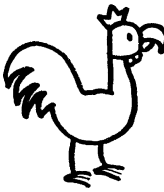
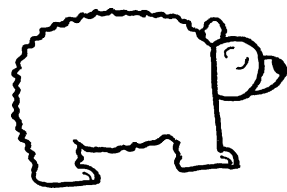

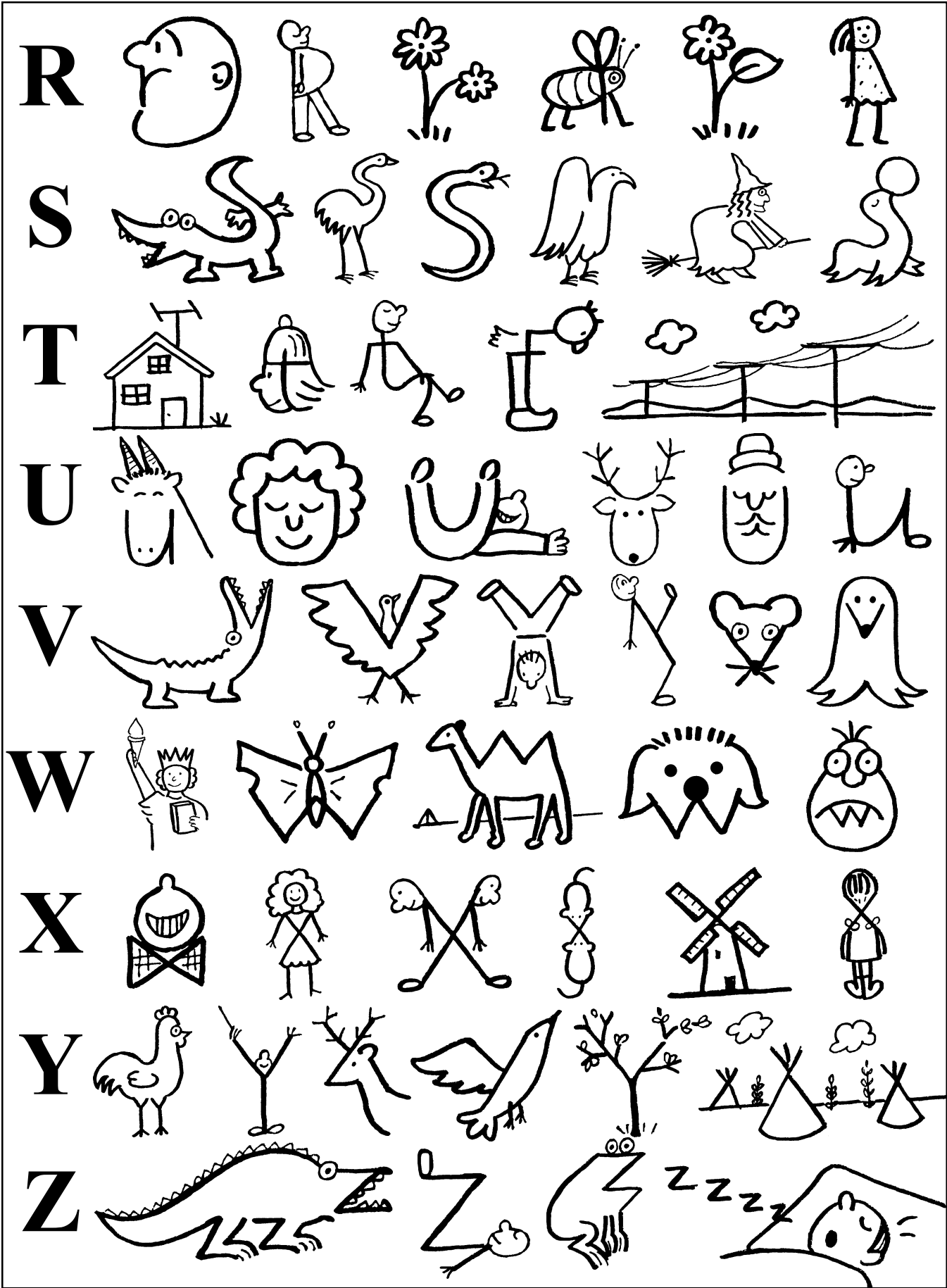

## HYDRAULIC TRUCK

This amazing hydraulic truck was designed by Mr. V. C. Kandkur of Hubli, Karnataka, India. Mr. Kandkur is a driver by profession with a penchant for mechanical things.

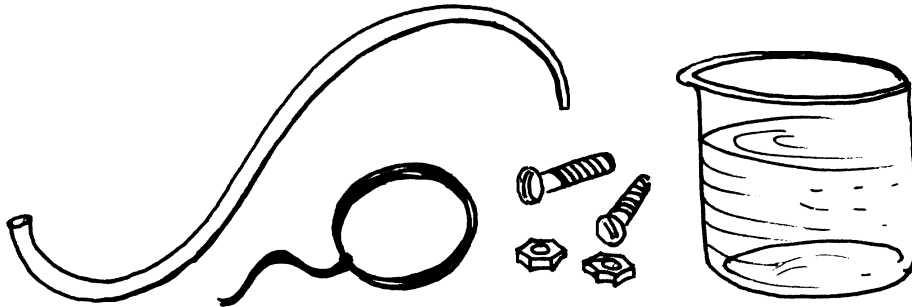

1. You will need several old 10-ml. plastic syringes, old plastic drip tubes, pieces of wood, screws, 10-mm aluminium square section, aluminium foil and ordinary hand tools.

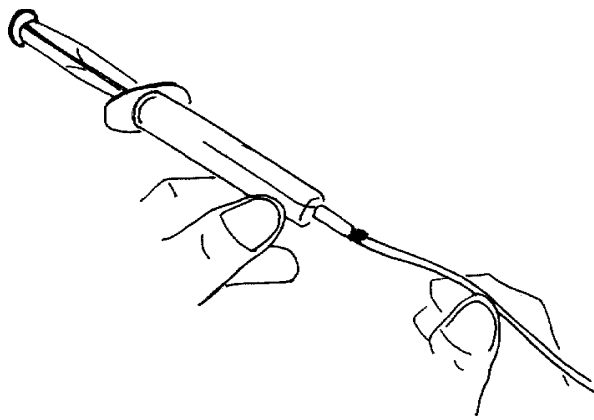

2. The movements of this truck - its swivel from left to right, the up-down motion of its jib, and the scooping action of the bucket is based on the principle of hydraulics.

It can be understood by filling two plastic syringes with water and attaching them with a plastic drip tube. On pushing the plunger of the first syringe the plunger of the second syringe will move out. Thus the motion is transmitted through water pressure from the first to the second syringe. The motion of the second plunger is transformed into the swivel, or up-down movement of the truck.

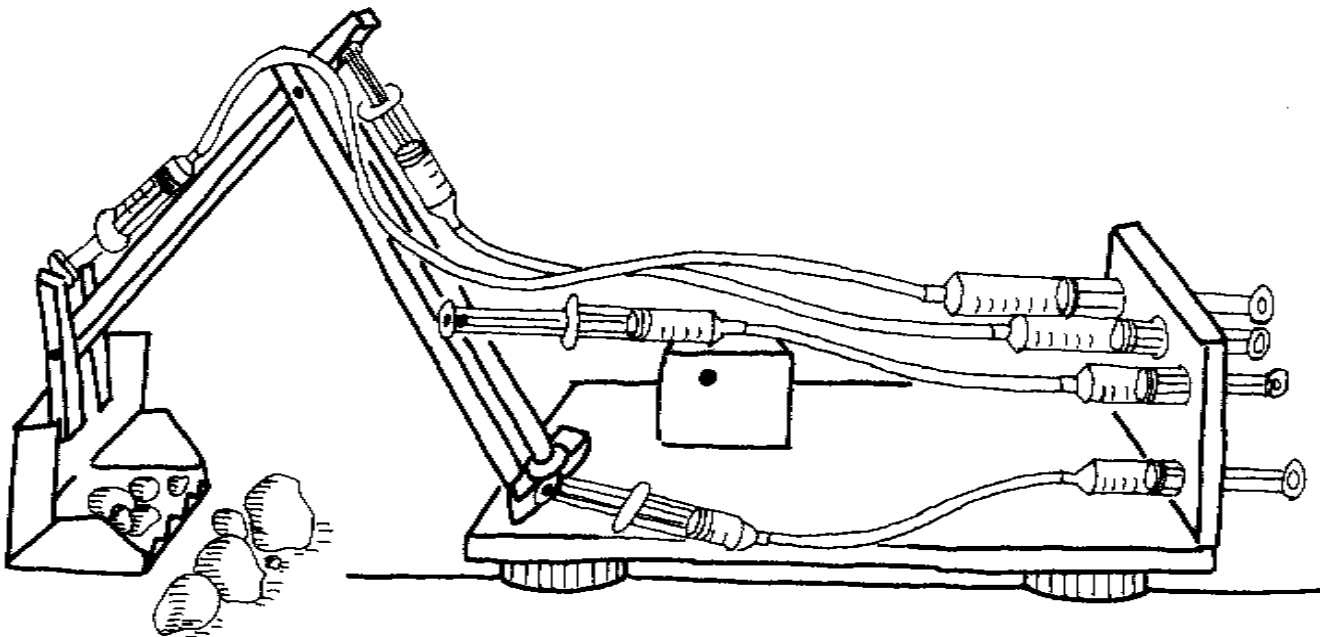

3. Make holes in a piece of wood and fix the syringes as shown. Make the boom and jib of the truck using aluminium square sections. For relative movement of the long arms they should be hinged using a screw and nut. Ensure that all joints move freely. Attach wheels made of plastic lids to give the hydraulic truck a more realistic look.

## DOING THEIR DUTY

Why do people obey orders even when it goes against their conscience?

Why do human beings kill other humans? Soldiers kill enemies and civilians with relative ease when commanded by authority. From 1933 to 1945 millions of innocent Jews were systematically slaughtered on command and shoved into gas chambers. These inhumane policies may have emerged in the mind of a single person - Hitler, but they could not have been implemented unless a large willing force was ready to obey orders. The German soldiers were brought up in the most rigorous code of obedience and in the name of obedience they assisted in the most hideous and large scale murders in the history of the world.

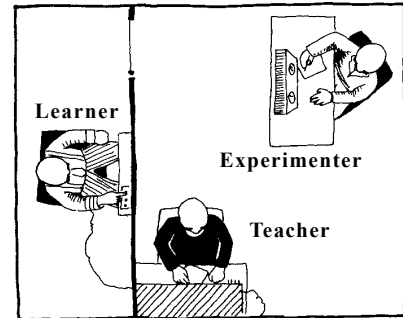

The Nazi extermination of European Jews is the most extreme instance of cruelty. Yet in lesser degree this type of thing is constantly recurring. Ordinary citizens are constantly ordered to destroy other people in the name of nation, religion, patriotism and language. People consider it their duty to obey orders. Thus obedience to authority, long praised as a virtue, becomes a heinous sin when used for a malevolent cause.

Conservatives argue that the very fabric of society would be threatened by disobedience. So, it is better to follow orders even if they are sometimes immoral. But humanists insist that the moral judgements of the individual must override authority when they are in conflict.

In the early 1960's an experiment was carried out in Yale University. The experiment was simple. It was concerned with the effect of punishment on learning. Two people were involved - one a "teacher" the other a "learner". The "learner" was taken to a room, seated on a chair, his arms strapped to prevent excess movement, and an electrode attached to his wrist. He was told that he was to learn a list of pair words.

If the "learner" gave a wrong answer, the "teacher" was expected to punish by administering an electric shock. The "teacher" could increase the intensity of the shock from 15-volts to 450-volts. The point of the experiment was to see how far a person would proceed in a concrete and measurable situation in which he was ordered to inflict increasing pain on a protesting victim. At what point would the subject refuse to obey the experimenter.

When the "learner" received a shock of 75-volts he grunted. At 120- volts he complained verbally. At 150-volts he demanded to be released from the experiment. His protests continued as the shocks escalated, growing increasingly vehement and emotional. At 285-volts his responses could only be described as an agonized scream.

Many "teachers" kept giving increasingly large shocks despite the pleadings of the "learner" to be released. The experiment was tried with a 1000 different "teachers". Almost 700 gave shocks to the "learners". In fact the "teacher" in the experiment was a genuinely naïve subject. He just came to the laboratory as a participant. The "learner" was a professional actor who actually receives no shock at all. The victim just feigned the shocks.

How does one explain this behaviour?

Many "teachers" administered shocks to the victims at the severest level. Were they all monsters? Did they represent the sadistic fringe of society? Almost two-thirds of the participants fell into the category of "obedient" subjects - they went on administering greater electric shocks. But they were all ordinary people drawn from various sections of society.

The most fundamental finding of the study: ordinary people simply doing their jobs, and without any particular hostility on their part, could become agents in a terribly destructive process, and relatively few people have the resources to resist authority. Americans bombing Vietnamese children said they "did it for a noble cause." The terrorists who kill innocent people in the name of religion, nation, patriotism offer the same plea.

George Orwell caught the essence of the situation:

"As I write, highly civilized people are flying overhead, trying to kill me. They do not feel any enmity against me as an individual, nor I against them. They are only 'doing their duty' as the saying goes. Most of them, I have no doubt are kind-hearted, law abiding men who would never dream of committing murder in private life. On the other hand, if one of them succeeds in blowing me to pieces, with a well placed bomb, he will never sleep the worse for it."

*From: OBEDIENCE TO AUTHORITY - Stanley Milgram*

## HAND SHADOWS

Making shadow pictures is great fun. All you need is an electric light without a shade and a sheet. To throw shadow picture on the sheet you must have your hands between the light and the screen. You will have to adjust your hands and fingers to make interesting and convincing pictures on the screen.

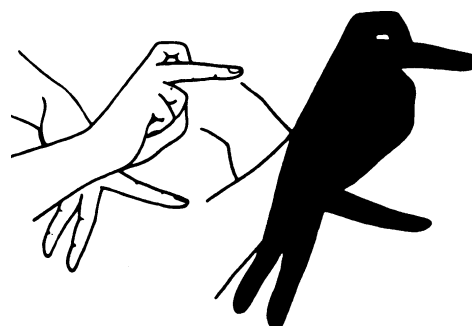
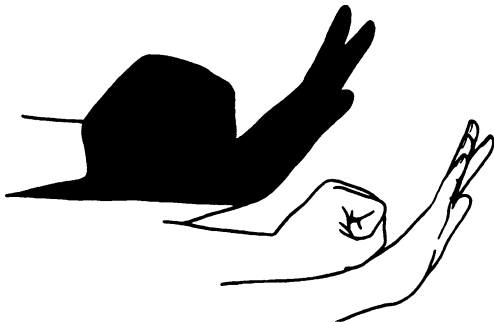
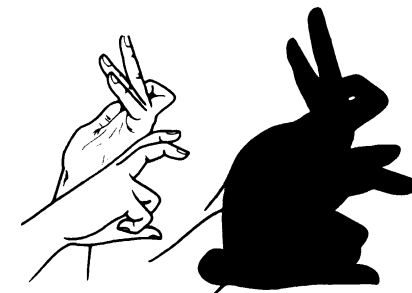
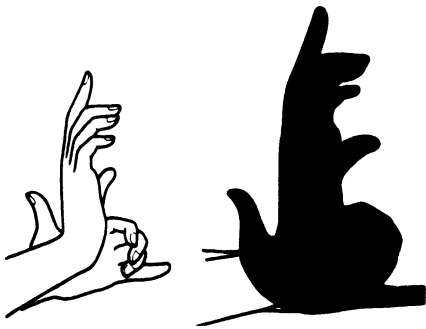
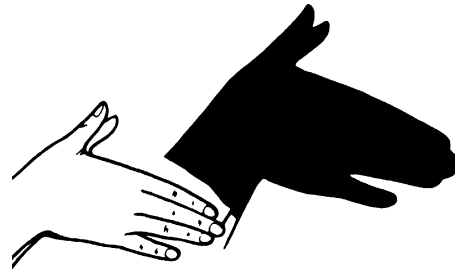
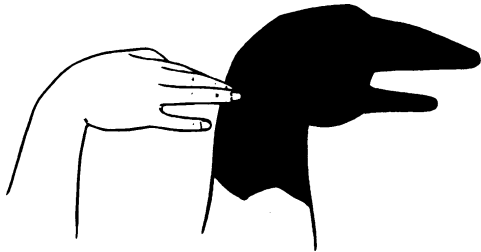
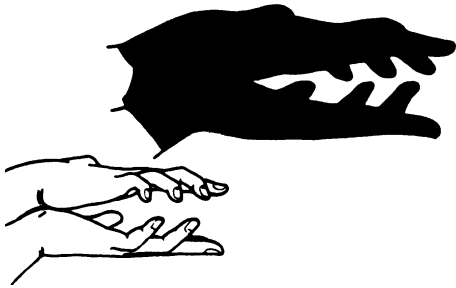

## MATCH MAGIC

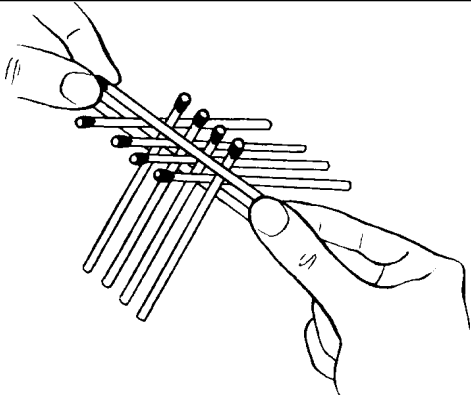

1. This is a puzzle rather than a trick. You put one match on the table and then lay nine others across it. Then ask your friend to lift all the matches using only one more match.

The only way to lift the entire assembly is to place the extra match on top of the others so that it is placed exactly over the bottom match, with its head at the opposite end. Then grasp the ends of the top and bottom matches, hold them firmly together and you can lift all of the matches without difficulty.

2. In a variation of the above problem you lay one match on the table and place twelve others across it, alternating from one side to the other, with the heads all close to the centre match. Challenge your friends to add one more match and then lift them all with a single match. This can be done by laying the extra match between the heads of the crossed matches, making sure that it is exactly centred. On picking up the bottom matches carefully, the top matches will hold the heads of the others in position, and you can lift them all without dropping any.

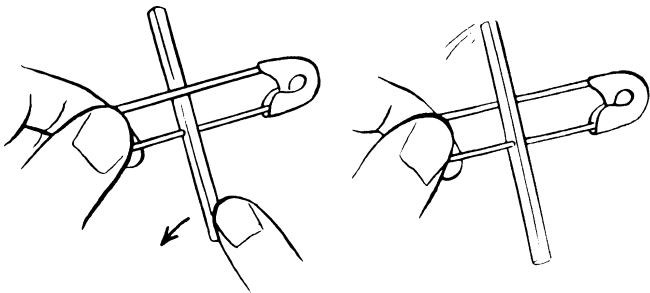
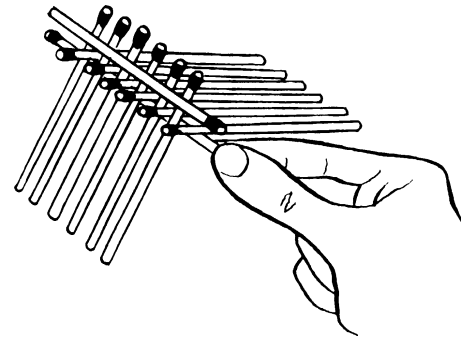

3. Push the point of the safety pin through the centre of a headless matchstick. Then close the safety pin. Hold the pin at either end with the left index finger and thumb, and snap one end of the matchstick with your right forefinger, making it revolve and pass through the solid steel bar of the safety pin. This illusion is produced because the match actually spins in the opposite direction.

Instead of moving upwards, the far end of the matchstick goes down, and the near end flies up, faster than the eye can follow, and stops against the top bar. Since the match head was cut off, both ends look exactly alike and one end is substituted for the other.

4. You show a box of safety matches, partly open it to reveal that it is full. However, when you turn the matchbox upside down the matches do not fall out. To perform this trick you will need a box of safety matches and one short-ended match. Break off the head of one match so that it is a little shorter than the others. Place it crosswise in the drawer, above the other matches, so that it is wedged between the sides.

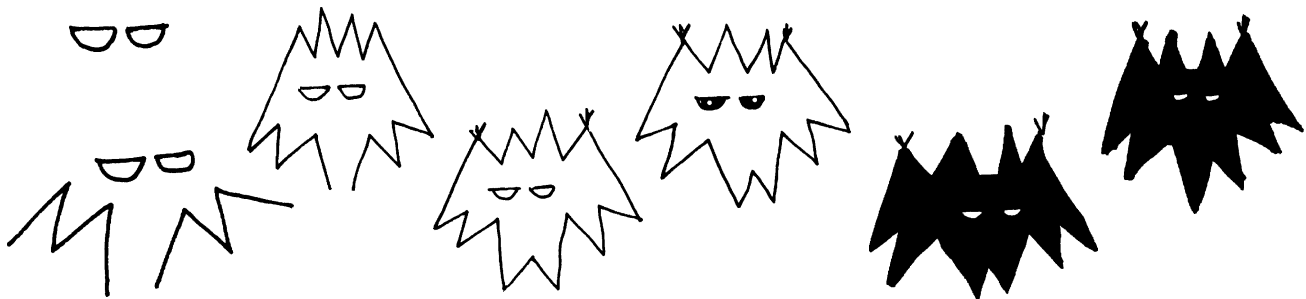
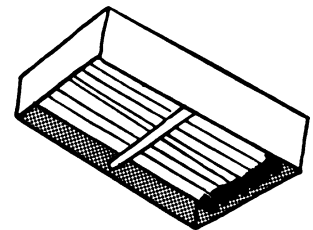



## VALUE OF $\pi$

You could find the value of pi quite accurately by dropping toothpicks!

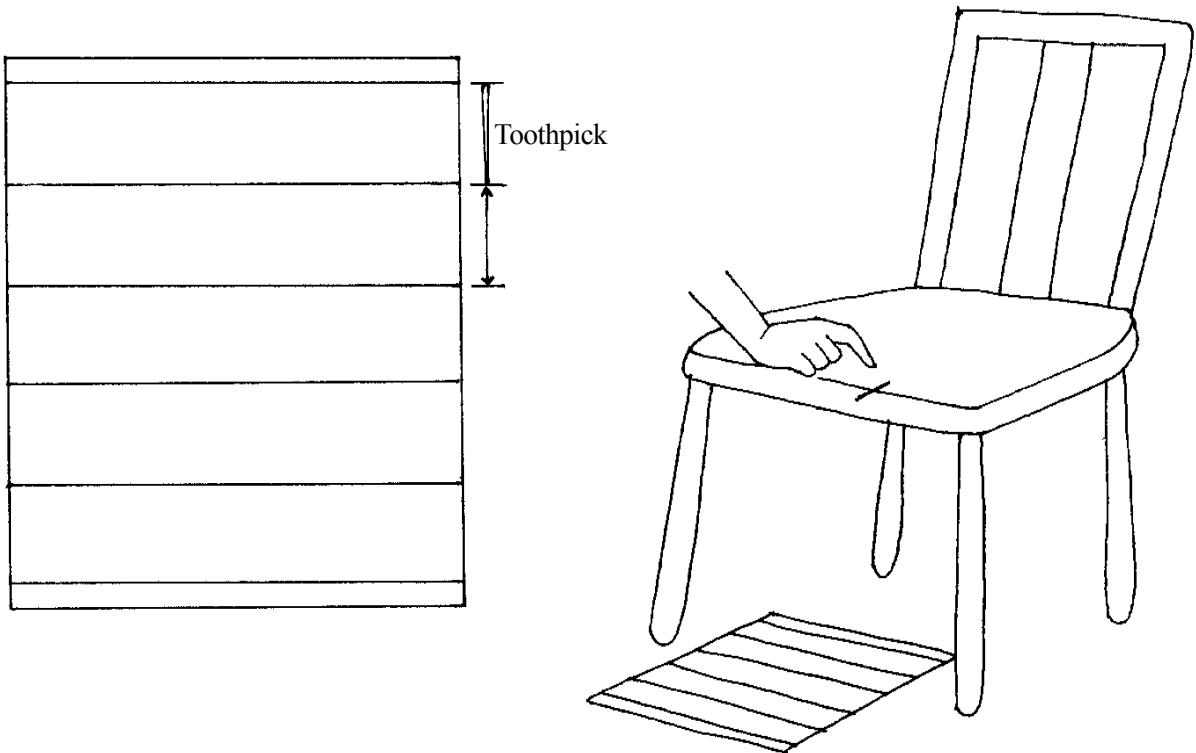

Count Buffon did this interesting experiment. You can repeat it 300 years later. Make a series of parallel lines on a sheet of paper. The lines should be one toothpick apart. The toothpick will play a crucial part in this experiment. Hold the toothpick on the edge of a chair and let it fall onto the ruled paper as shown.

Record the number of times any part of the toothpick touches any line. Also note down the number of times the toothpick does not touch any line. Count Buffon found that if you drop the toothpick enough times, a definite relationship exists between the two possibilities. The chance that the toothpick will touch a line is  $2/3.14$  or  $2/(\pi)$ . We know that the circumference of a circle is equal to its diameter multiplied by  $(\pi)$ . The constant  $(\pi)$  has been identified with a circle. Isn't it strange that the toothpick dropping experiment can help you find the value of  $(\pi)$ .

An Italian mathematician Lazzarini dropped the toothpick 3408 times. The value of  $(\pi)$  which he obtained was 3.1415929.. an error of just .0000003 !

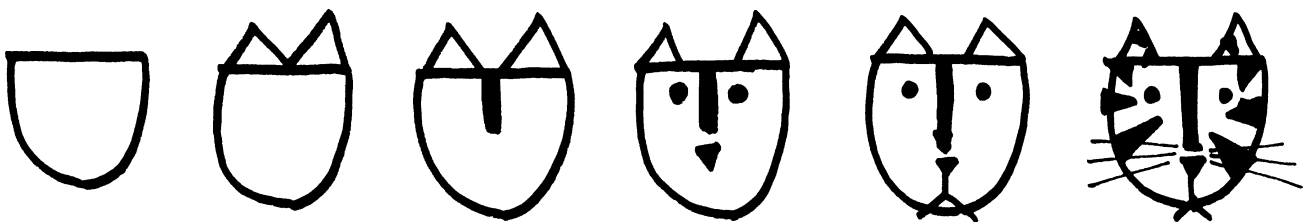

## CROSS INTO SQUARE

How can you cut a cross into pieces that can be fitted together to make a square?  
Trace the square on a paper, cut it up and then cut it up into pieces.  
There are actually three different ways in which the cross can be made into a square.

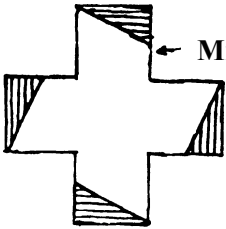
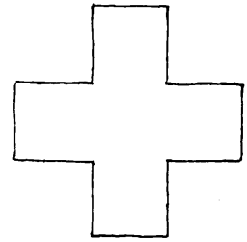

Midpoints of sides

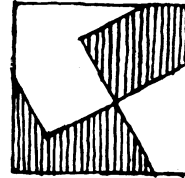
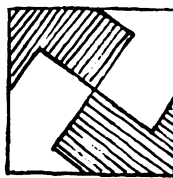
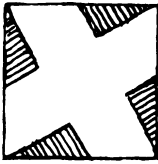
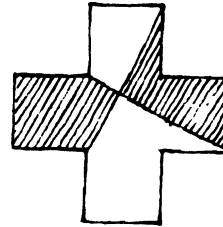
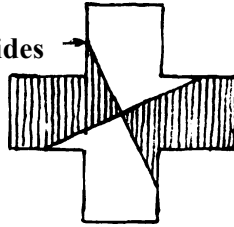

## PERFORATED SYMMETRY

A piece of paper was folded and punched just once with a paper punch.  
How can you fold and punch a paper so that it looks like the drawing when unfolded.

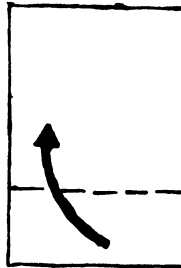
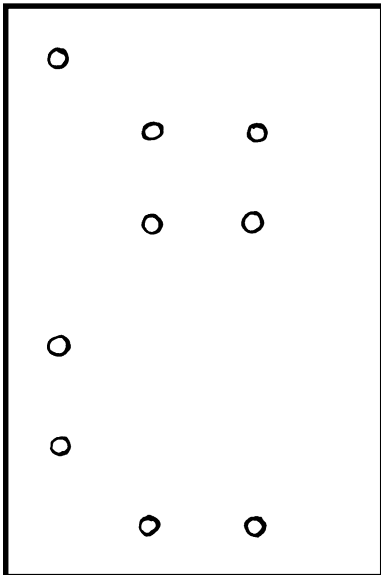

1. Fold the bottom edge of the paper one-third upwards.

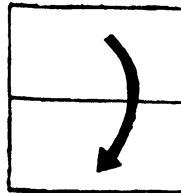

2. Fold the top edge one-third down.



3. Fold corner up.



4. Fold point over.

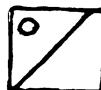

5. Punch hole here.

## SHIFTING WATER

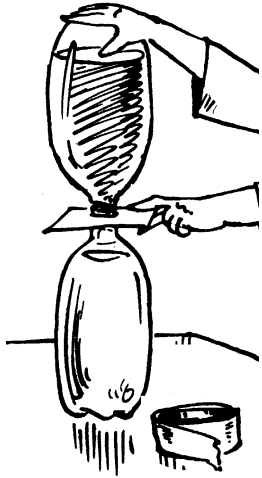

1. Take two 1-litre capacity plastic bottles (remove the caps) and fill them with water.
2. Add two table spoons of salt and some ink to the first bottle. Cover the top of the bottle with your hand and shake to mix the contents.
3. Place a card sheet on the top of the first bottle. Hold the card in place with one hand and flip the bottle over.
4. You may need some help for this action. Balance the opening of the first bottle directly over the mouth of the other bottle. Once the bottle mouths are aligned, pull out the card. Adjust the bottles so that water does not slip. Watch what happens.

The volume of water in each bottle is the same. If the density of water in each bottle was the same then the water would not shift around. In this experiment you use fresh water and salt water. Salt water is heavier and so it sinks down.

## HOT, HOTTER, HOTTEST!



1. Take three spoons of different materials - a plastic, a wooden and a metal spoon. Place a small dab of butter at the end of each spoon handle. Push a little bead into each dab of butter.

Place the spoons into a cup of hot water. The handles should point up. The handles should not touch each other. Which bead will fall first?

When something is heated its molecules begin to move faster. Molecules in motion bump into other molecules making them move too. Heat spreads by this process of conduction. Some materials are better conductors than others. Heat travels faster in the metal spoon, warming the butter and causing the butter to melt and causing the bead to fall first.

## TETRAHEDRON FROM AN ENVELOPE

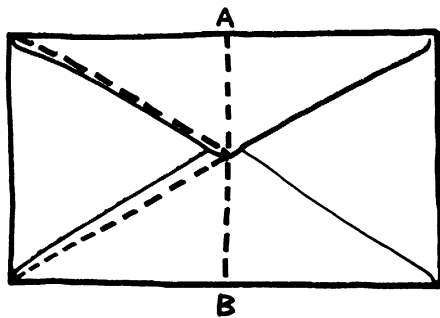

1. A very simple way to make a tetrahedron is to take an envelope and seal it. Draw an equilateral triangle, with all three sides the same length, on one end. Cut along the dotted line from **A** to **B**.

Hold point **A** with one hand and point **B** with the other hand. Push **A** and **B** towards each other until they meet and make a tetrahedron.

## SPOOKY FAN

You will require two ring magnets, a cycle spoke, a bead and some card sheet to do this experiment.

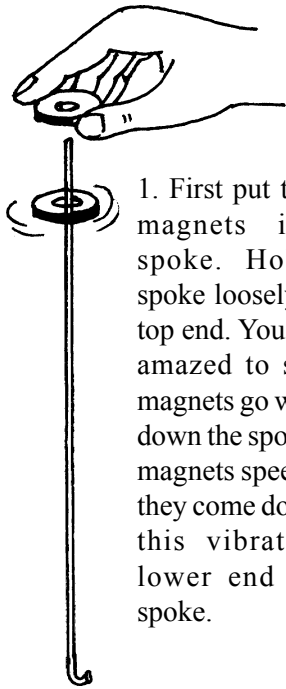

1. First put the ring magnets in the spoke. Hold the spoke loosely at the top end. You will be amazed to see the magnets go whirling down the spoke. The magnets speed up as they come down and this vibrates the lower end of the spoke.



2. Place a bead (to reduce friction) and a card fan on the lower end of the spoke. The bead enables the fan to rotate freely. Now place the magnets on the top end and hold the spoke loosely at the top.

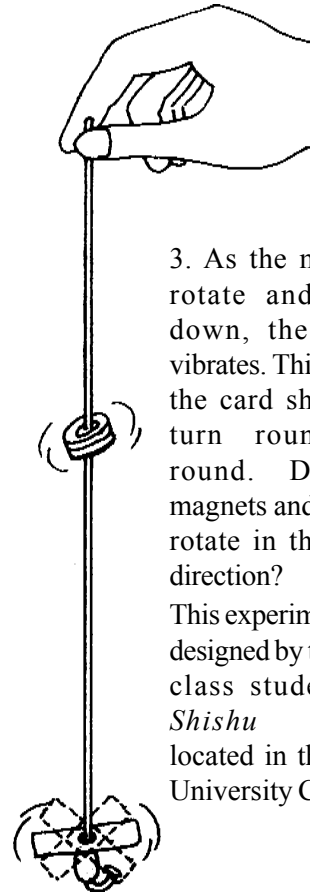

3. As the magnets rotate and come down, the spoke vibrates. This makes the card sheet fan turn round-and-round. Do the magnets and the fan rotate in the same direction?

This experiment was designed by the sixth class students of *Shishu Vihar*, located in the Pune University Campus.

## BUZZING INSECT

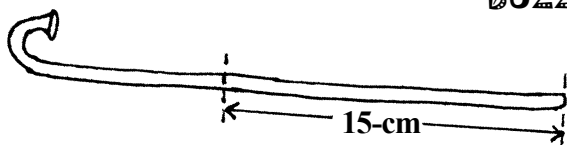

1. Cut a bicycle spoke so that it is 15-cm long.

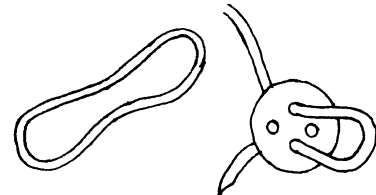

2. Cut a rubber band and weave it in a coat button.

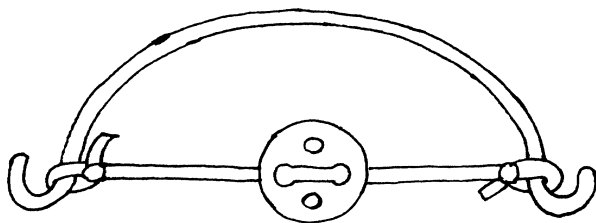

3. Using a nose pliers bend the ends of the spoke to make a bow. Tie the two ends of the rubber band to the spoke as shown. Now rotate the button so that you wind up the rubber band.

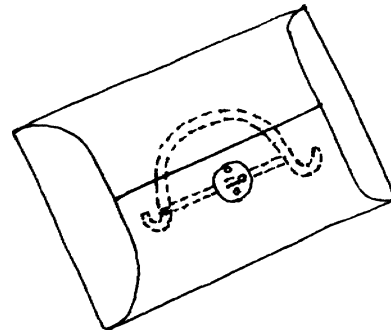

4. Now carefully put the bow inside an envelope. Make sure the rubber band does not unwind. Hand over the envelope to a friend. When your friend opens the envelope the button will start spinning against the sides of the envelope, sounding like a buzzing insect!

## CORRUGATED CREATIONS

Old computer or TV cartons are great to make lovely, usable furniture.

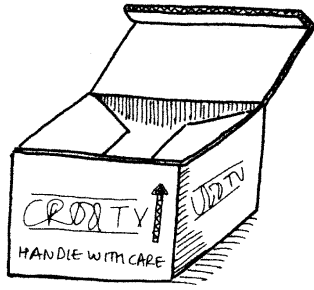

1. Corrugated sheets - a zigzag of paper sandwiched between two layers of paper makes lovely furniture. Ranjan De taught us these corrugated creations.

### BASE STRUCTURE

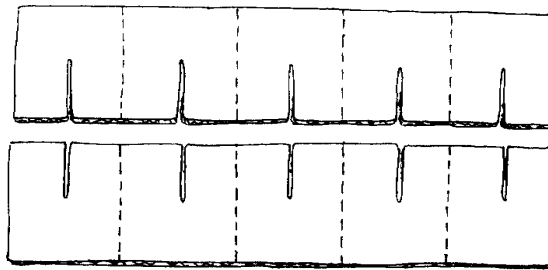

2. Flatten and open a corrugated box. Cut two rectangular flats 90-cm long and 25-cm wide. The dotted lines are 18-cm apart. Fold along the dotted lines. Cut five slits 18-cm apart as shown. The slits are 13-cm long.

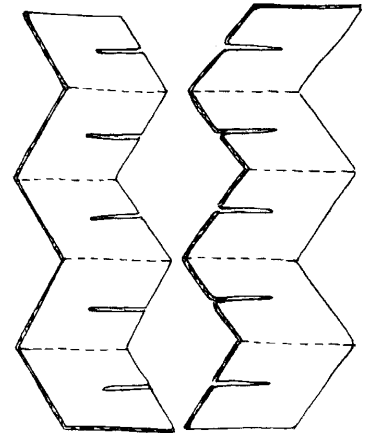

3. First score and then crease the two pieces along the dotted lines in a fan shape pattern.

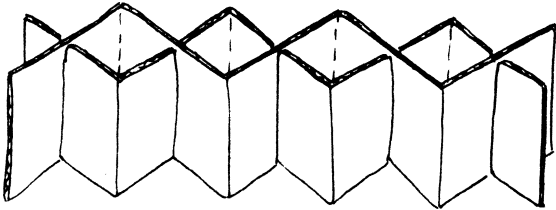

4. Then interlock the slits. The shape can stretch and contract like an accordion.

5. Cut slits at 45-degree angles on all the accordion pleats as shown. The slit must start about 7-cm from the top. Using a cutter first cut the slits. Then widen them by running a screw driver in the slits.

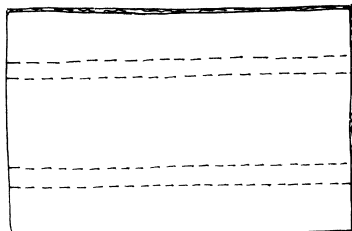
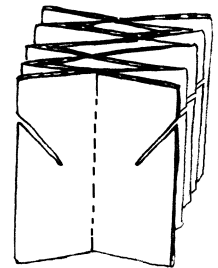

### SEAT

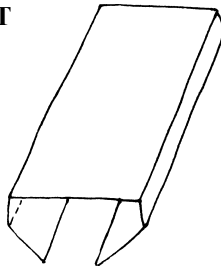

6. For the seat cut a rectangle 50-cm long and 45-cm wide. The big middle rectangle of the seat is 20-cm wide and the two sets of dotted lines are 2.5-cm wide. Score along all the four dotted lines and then fold to give the seat the shape.

### STOOL ASSEMBLY

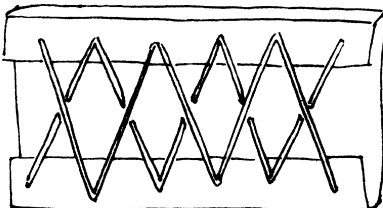
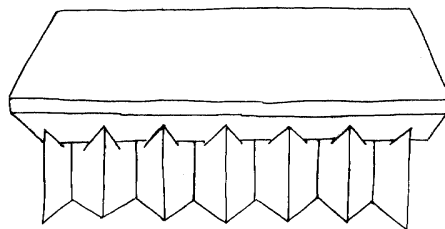
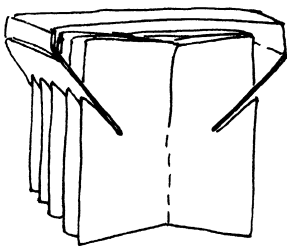

### STOOL FROM BELOW

7. Finally insert the flaps of the seat into the slits of the base structure to make a stool or a short bench. This is what the stool would look like from down below. The stool is all ready.

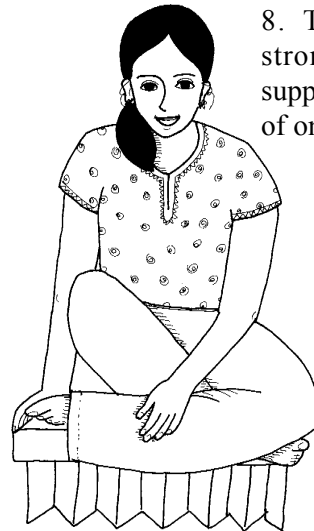

8. This stool is strong enough to support the weight of one person.

## BEAUTIFUL BRIDGE

To build this bridge you require patience, a steady hand and long (*Homelite*) matchsticks.

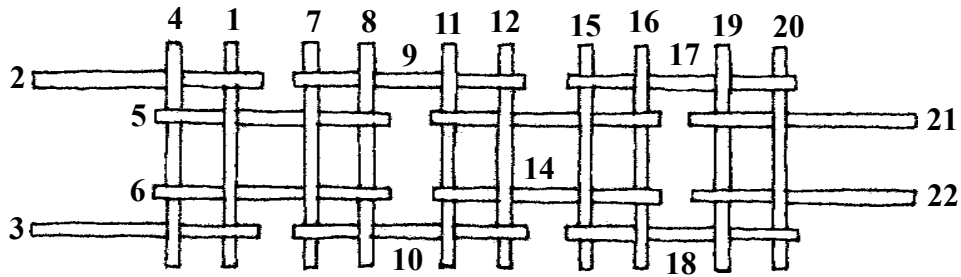

The matches have to be put together in the order shown in the illustration. Place match 1 on the table. On this, and at right angles to it, place match 2 and 3. Lay match 4 across the last two matches. So far you will find it quite easy, but now things will start getting a little tricky. With the thumbs and forefinger of one hand lift match 1. Slide matches 5 and 6 under 1 and over 4. Now place match 7 on top and match 8 underneath 5 and 6. Lift match 8 as you did earlier with match 1 and in matches 9 and 10 as shown. Continue in this manner until you run out of matches, or patience, or both.

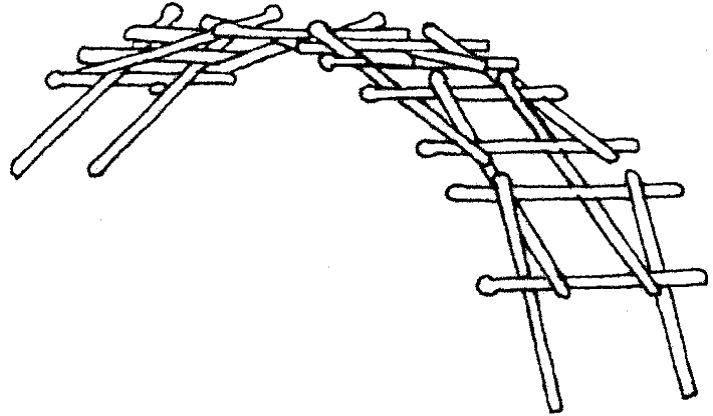

## DIGITAL DEXTERITY

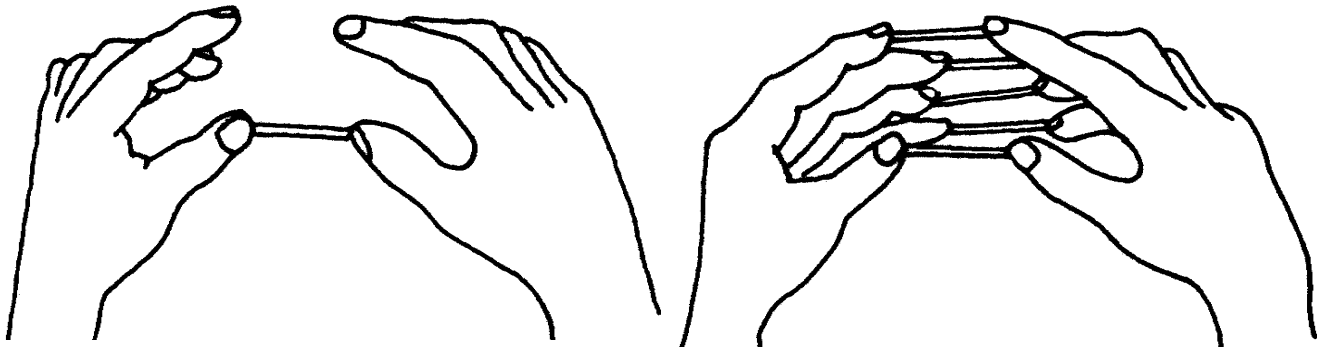

Place five matches on the table. Pick up the first match between your thumbs as shown. Pick up the second match between your first fingers taking care not to drop the first match as you do so. The third match is picked up between the second fingers, the fourth match between the third fingers, and the fifth between the little fingers.

When you have managed to do this successfully replace the matches, one at a time, on the table. Get a bunch of friends and see who can complete the whole sequence in the shortest possible time.

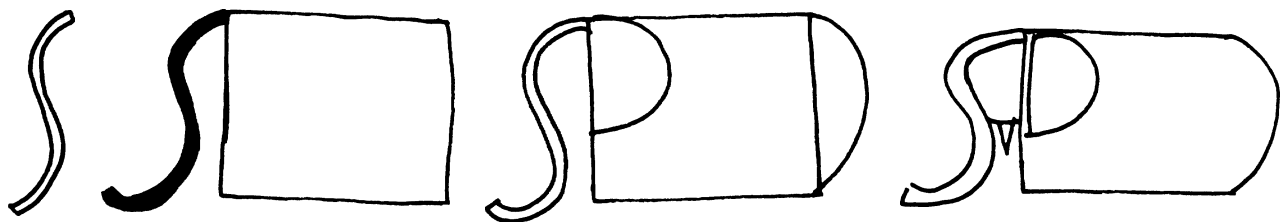

## FLYING KITE

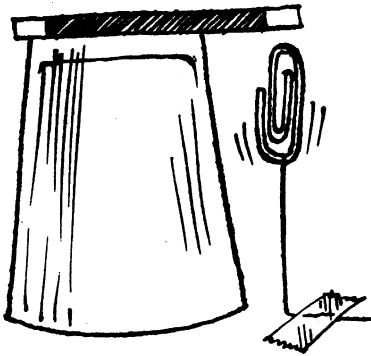

1. Turn a glass upside down and place it on a table. Tape a bar magnet on the top of the glass. The magnet should extend 3-cm over the edge of the glass. Take 20-cm of thread. Tie one end to a paper clip. Stick the clip to the magnet. Then lightly pull it down so that there is a gap between the clip and the magnet. Now tape the thread to the table so the clip keeps hanging and is still attracted to the magnet.

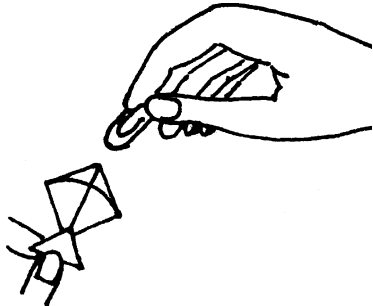

2. Alternately, make a small kite from card sheet. Insert a paper clip in the kite.



3. Attach a length of sewing thread to the kite-clip assembly.

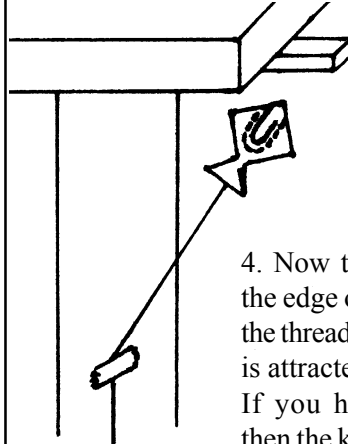

4. Now tape a magnet to the edge of the table. Tape the thread such that the kite is attracted to the magnet. If you hide the magnet then the kite will appear to be flying in the air.

## CAPILLARY CLOTH

Cloth is made of many thin fibres. They act as capillaries and draw up water.

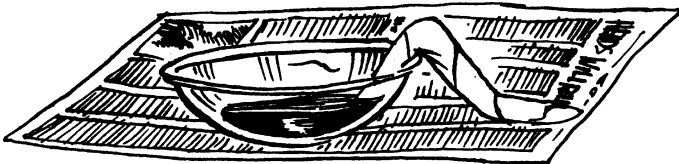

1. Spread an old newspaper on the floor.  
2. Fill a bowl halfway with water and place it on the newspaper. Put 2 tea spoons of ink in the water.

3. Roll an old cloth or handkerchief lightly into a tube. Place 5-cm of one end of the cloth tube in coloured water. Let the rest hang over the side of the bowl onto the newspaper.

4. After 10-minutes, remove the handkerchief and see how much it is wet. The coloured water will make it easier to see.

Cloth absorbs water through a process called capillary action. The tiny fibres of cloth have small spaces in between them. Water molecules move through the spaces by adhering to the fibres. As the water molecules move farther up the handkerchief, they attract and draw up other water molecules from below.

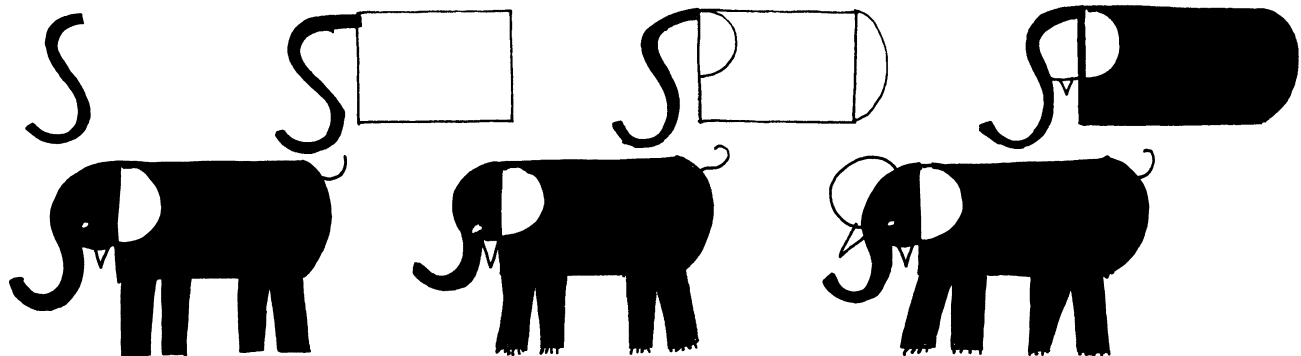

## BIRTHDAYS

There are more chances of finding someone with your birth date at a party, than you thought!



Probability problems are sometimes controversial because the mathematical answer, the true answer, is often contrary to what intuition might suggest. This failure of intuition is perhaps surprising.

One of the most counterintuitive probability problems concerns the likelihood of sharing birthdays. Imagine a football pitch with 23 people on it, the players and the referee. What is the probability that any two of those 23 people share the same birthday? With 23 people and 365 birthdays to choose from, it would seem highly unlikely that anybody would share the same birthday. If asked to put a figure on it most people would guess a probability of perhaps 10% at most. In fact, the actual answer is just over 50% - that is to say, on the balance of probability, it is more likely than not that two people on the pitch will share the same birthday.

The reason for this high probability is that what matters more than the number of people is the number of ways people can be paired. When we look for a shared birthday, we need to look at pairs of people not individuals. Whereas there are only 23 people on the pitch, there are 253 pairs of people. For example, the first person can be paired with any of the other 22 people giving 22 pairings to start with. Then, the second person can be paired with any of the remaining 21 people (we have already counted the second person paired with the first person so the number of possible pairings is reduced by one), giving an additional 21 pairings. Then, the third person can be paired with any of the remaining 20 people, giving an additional 20 pairings, and so on until we reach a total of 253 pairs.

The fact that the probability of a shared birthday within a group of 23 people is more than 50% seems intuitively wrong, and yet it is mathematically undeniable. Strange probabilities such as this are exactly what bookmakers and gamblers rely on in order to exploit the unwary. The next time you are at a party with more than 23 people you might want to make a wager that two people in the room will share a birthday. Please note that with a group of 23 people the probability is only slightly more than 50%, but the probability rapidly rises as the group increases in size. Hence, with a party of 30 people it is certainly worth betting that two of them will share the same birthday.

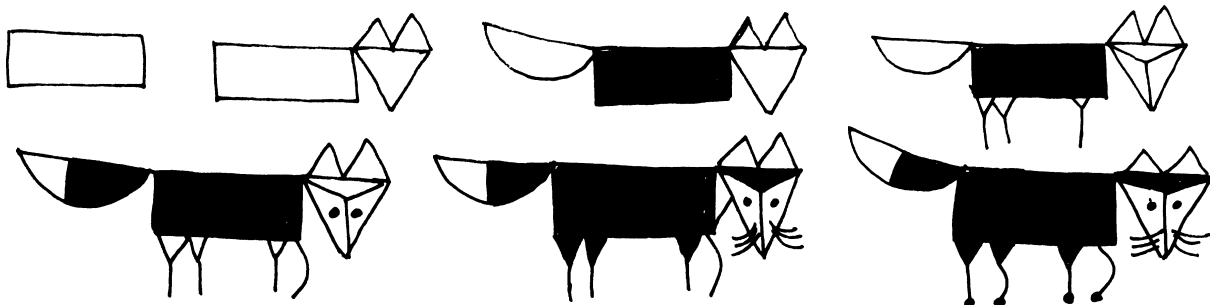



## HANKY RABBIT

A big handkerchief is all you would require to make this delightful rabbit.

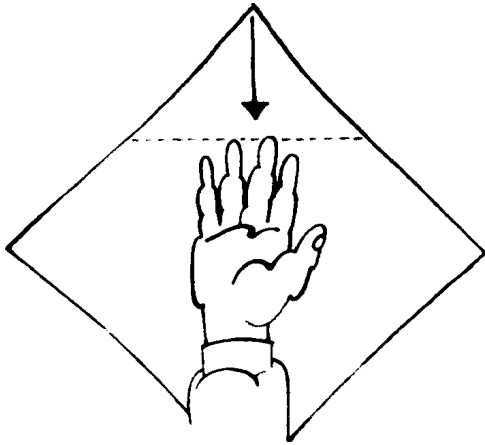

1. Lay the hanky out on the table with one corner pointing towards you. Lay the back of your right hand on the hanky, just above the centre.

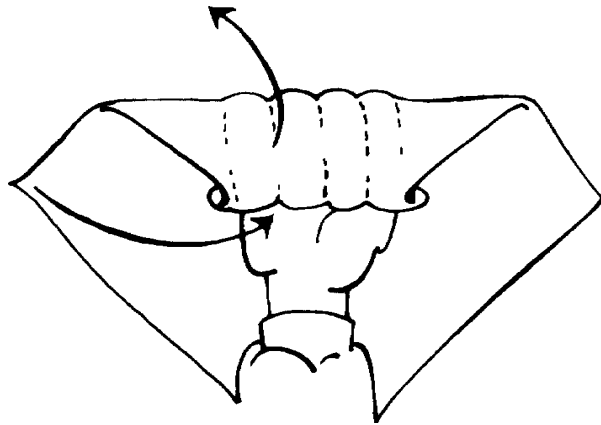

2. Fold the top corner down, covering your fingers and thumb. Curl all four fingers into a fist, tucking in the corner you just folded down.

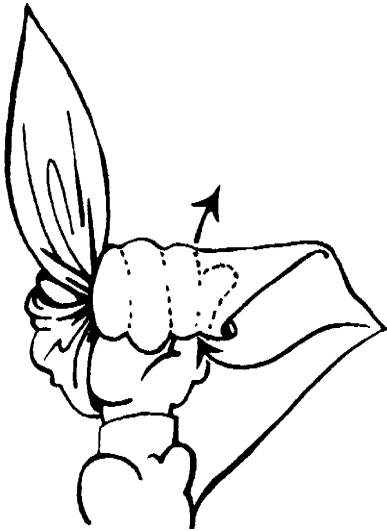

3. Take the left corner, bring it down around your little finger and then up between your little and ring finger. Pull it through as far as it will go and hold it between the base of those two fingers as shown in the figure.

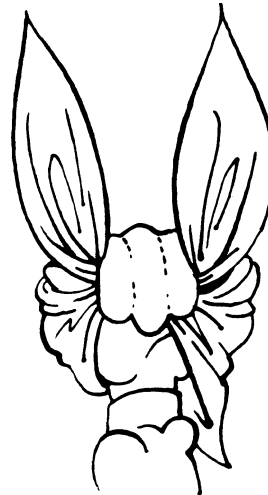

4. Repeat with the right corner, bringing it around the base of the thumb and up between your thumb and forefinger. Pull it through all the way and then tuck your thumb under your three middle fingers.

If the hanky is stiff enough, the ears will stand straight up. If you wiggle the tips of your middle three fingers you can make the nose do little tricks.

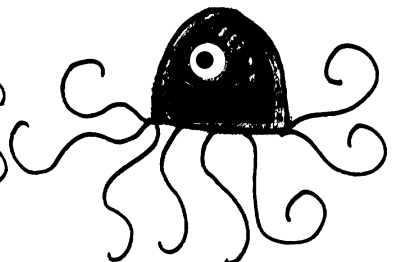
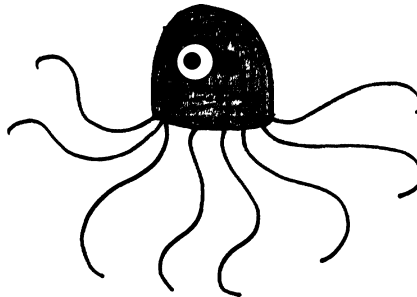
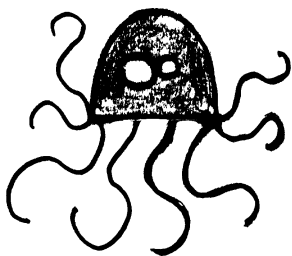

## DRIP MACHINE!

This amazing machine at first looks like a perpetual motion machine. So look carefully.  
Designed by Uday Patil this wonderful machine was the star attraction at the National Science Day Feb 28, 2006.

1. You will need an empty water bottle, saline tube along with the regulator, some wire, a few bicycle spokes, old rubber slipper, heavy metal nut, and ordinary hand tools.

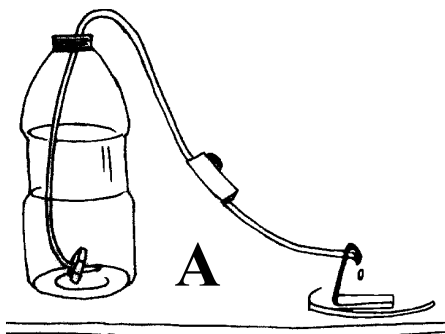
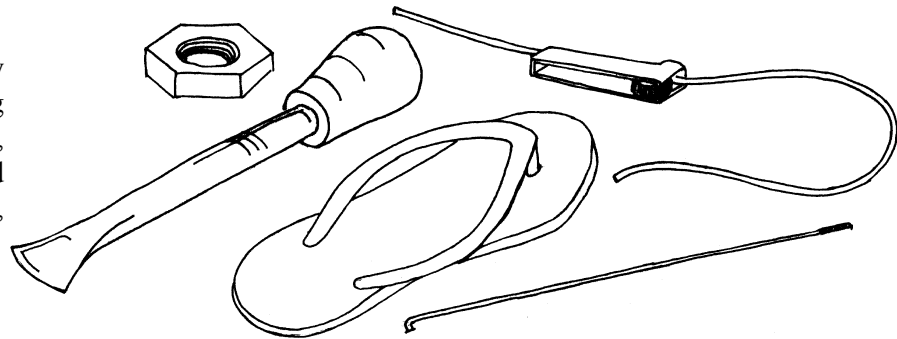

2. One end of the old saline tube is dipped in a bottle of water. This end of the tube is weighed down so that it doesn't float up. The regulator is adjusted so that water drops form and trickle down. This is shown in A.

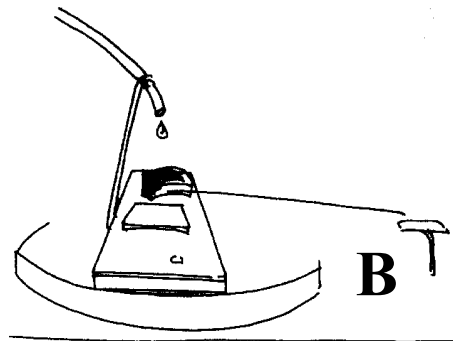

3. The other end of the drip tube is supported on a U shaped wire stand. The wire ends are inserted in a piece of rubber slipper. The water from the drip tube falls one drop each on a piece of sponge which is connected to an oscillating arm.

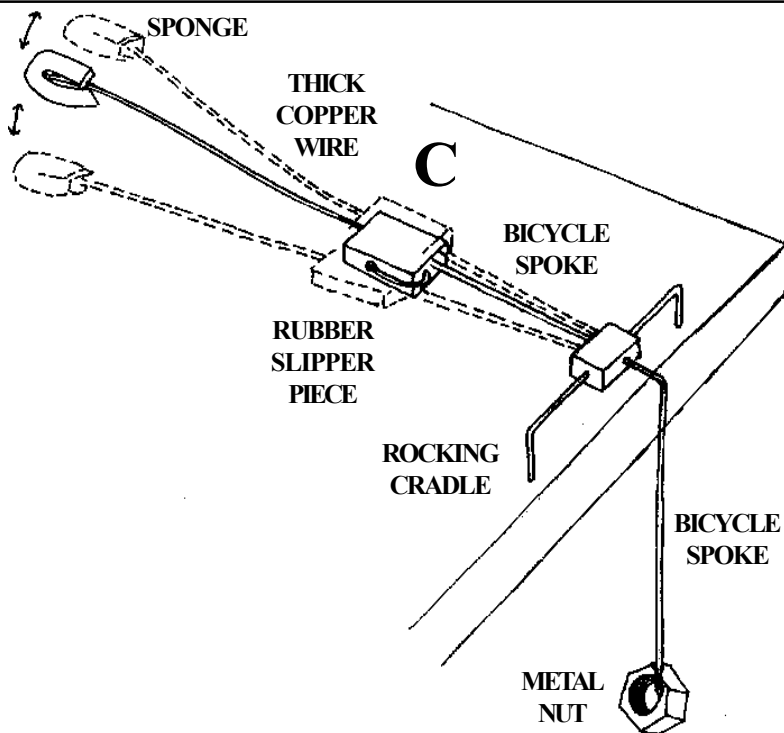

4. The oscillating arm C is the most critical. It consists of a rocking cradle which has an oscillating bob (metal nut) at the bottom and a horizontal wire arm moving the sponge up-and-down by 7-8 cm. The cradle is made from a piece of U stiff wire (8-cm long and 2-cm high), pierced through a rubber slipper. The U cradle rocks up-and-down like a see-saw. The rocking arm is made of a piece of thick copper wire one end of which is inserted in a piece of rubber slipper. The other end is bent to hold a piece of sponge. Both the rubber pieces are connected by a piece of stiff wire (bicycle spoke). The use of rubber pieces and wires enables one to adjust the length of the oscillating wire arm.

5. This is the final assembly. The working can be described as follows: A bottle filled with water is perched on a height. Water trickles down from the right end of the saline tube. The trickle of water - the speed at which the drops fall can be adjusted by the drip regulator. The water drop falls on a piece of sponge on the oscillating arm.

As the arm moves up-and-down the oscillating pendulum helps it maintain a steady beat. Given an initial push the pendulum will move the arm up-and-down until the frictional forces of air and the U shaped cradle bring it to a halt. After a small interval the mechanism will come stop. The 'falling drops' ( usually one per oscillation) on the sponge connected to the left end of the rocking arm - provide the 'impulse' or momentum for the mechanism to continue swinging. The trick is to adjust the speed of the drops such that the momentum of the falling drops just overcome the frictional forces of the swinging arm. The falling drops are an equivalent of the 'spring' in a grandfather clock, or the electric impulse in a quartz clock.

The beauty of this mechanism is its simplicity and transparency. In quartz clocks you can't see what is happening. In comparison, this almost perpetual motion machine is a treat. It can be made with the humblest materials anywhere. The one in our science centre ran for over 8-hours on a litre of water providing hours of fun!

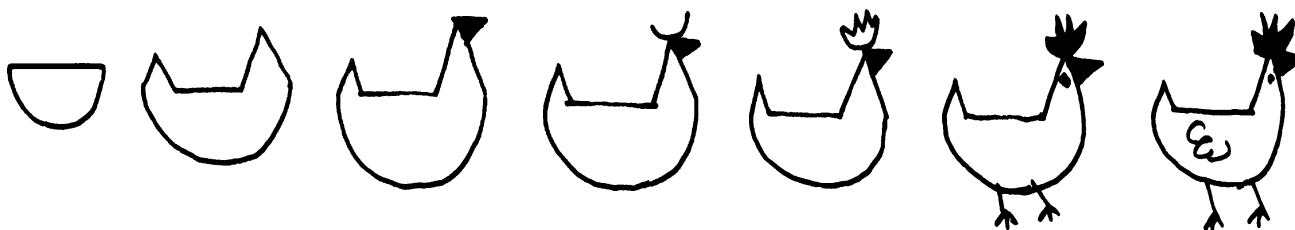
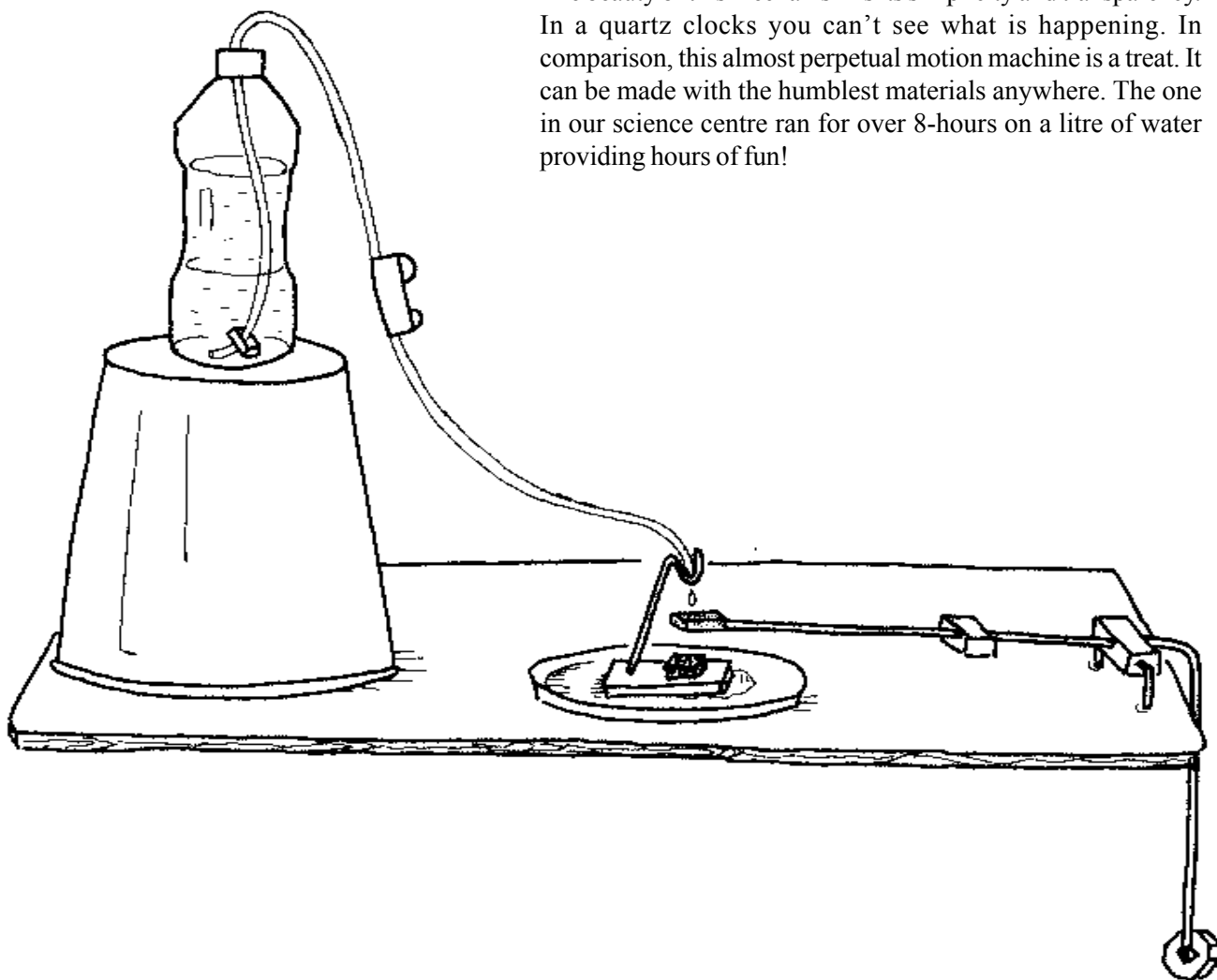

## BIRD PLANE

Fly a flock of peace birds.

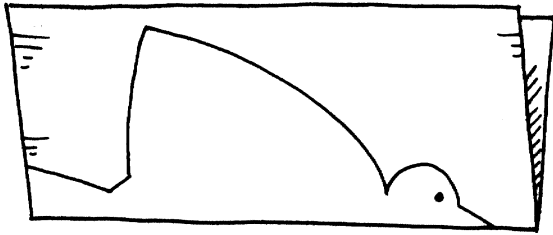

1. Fold an 20-cm x 27.5-cm piece of white paper into half.
2. Draw the side-view of a bird as shown.
3. Cut off the extra paper around the outline of the bird and its wing.
4. Fold each wing down to make an airplane shape.
5. You can write a message of peace on the wings of the birds.
6. Then let it peacefully glide.

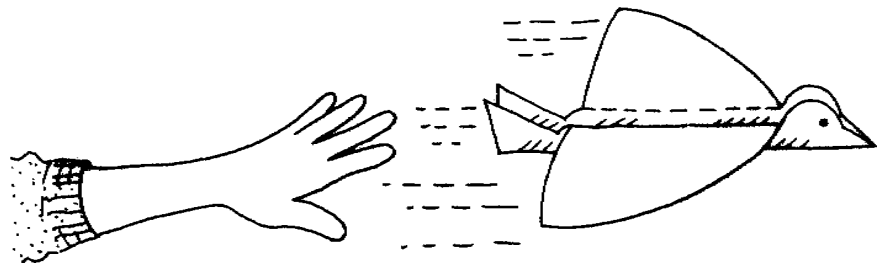
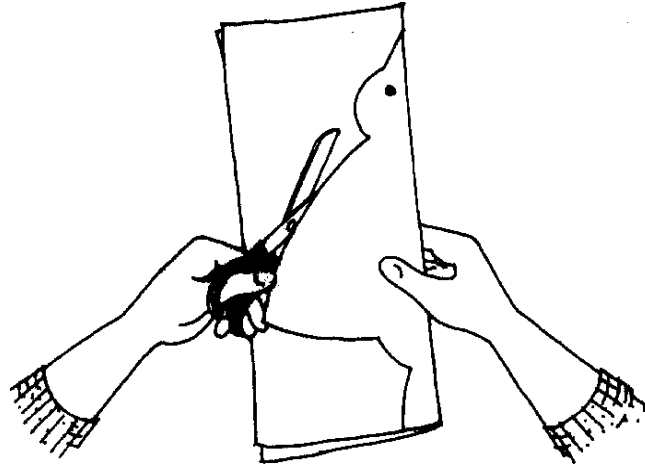

## PAPER BEADS

Make a necklace of colourful beads and gift it to a friend.

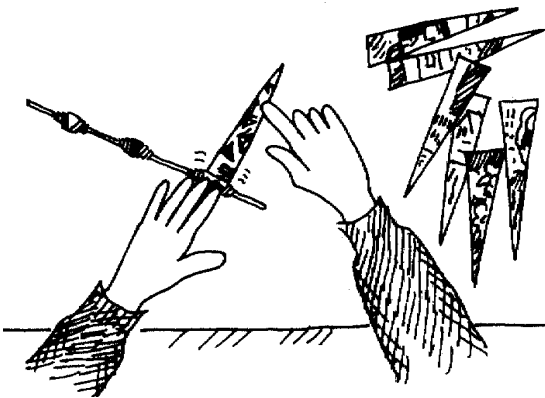

Make a cardboard template of a triangle that has two long sides that are 13-cm long and a shorter side that is 3-cm long. Use the template to trace and cut triangles from old magazines. Each triangle will be rolled up into a bead. To make a bead, take a triangle with the white side up and roll the wider end around a piece of string. Work carefully and continue to roll, making sure that the bead builds evenly. Keep rolling the paper tightly until the last 5-cm. Then apply glue and stick the narrow end. Let the bead dry on the string. When the glue is dry give the beads a coat of clear varnish. This protective layer will make the beads shine and they will look attractive.

# GLIDER

You can use a foam tray to make a super glider.

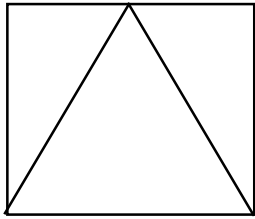

1. From the flat part of the tray, measure and draw a square that's 10 or 12-cm on each side. Cut out the square. Make a dot on the middle of one edge of this square. Draw lines from the dot to each of the opposite corners to make a triangle. Cut along the lines. You'll have one big triangle and two little ones.

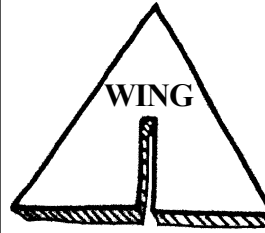

2. The big triangle will be the wing. Measure to the middle of the bottom of the wing and make a dot. Cut a slit from the dot to the centre of the wing and remove the little strip of foam. The slit should be the thickness of the foam.



3. One of the little triangles will make the rudder. Cut a slit in it just like the one you cut in the big triangle. Snip off the right corner so that it looks like the one in the picture. (The other triangle could be used as a step-knee rudder)

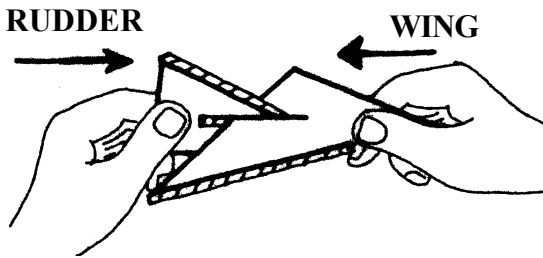

4. Push the rudder into the wing so that the two slits fit together. If it feels loose you can tape it to the wing. The rudder will stick out a little from the back of the wing.

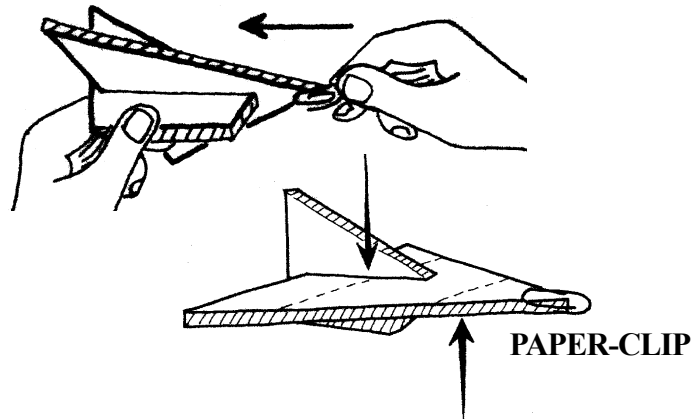

5. Now test-fly it. Hold the bottom part of the rudder and throw it forward. If the glider just wobbles and falls on the floor, then it needs more weight in its nose.

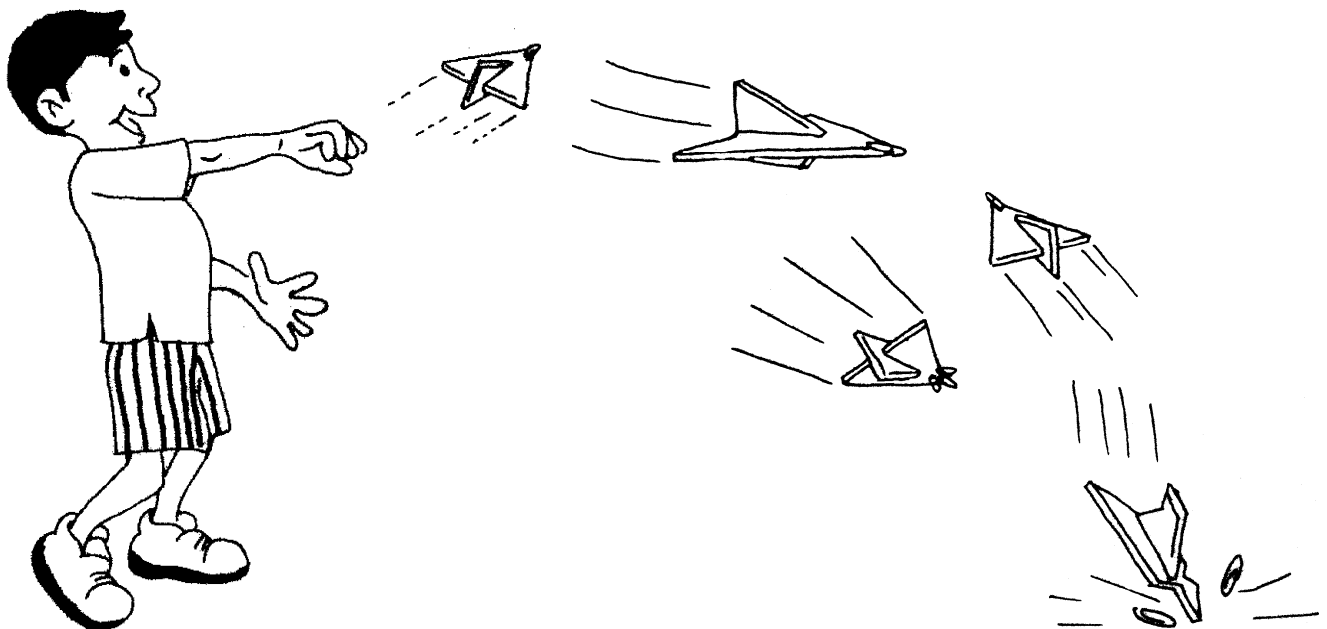

## ICE-CREAM STICK BOMB

You just require five used ice-cream sticks for making this gentle bomb.

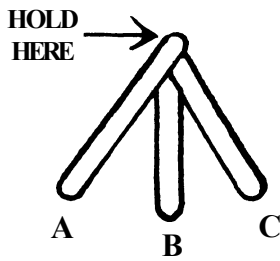

1. Hold three ice-cream sticks, A, B and C together at one end with B on the bottom, spread as shown in the diagram.

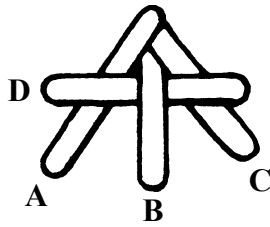

2. Insert a fourth stick D, over A, under B and over C as shown.

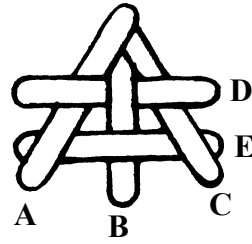

3. Insert the last stick, E under A, over B, and under C as shown.

The assembly of 5 ice-cream sticks will hold itself together. Try throwing it up in the air or against a wall. When it lands, it will “explode” and the sticks will fly in all directions.

## MAGNETIC HAND

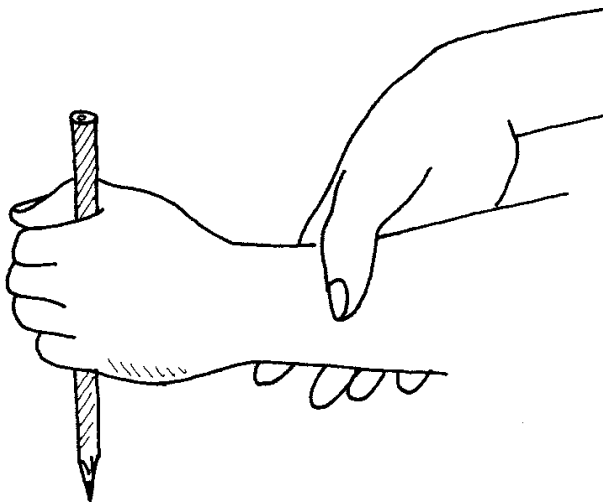

1. Hold a pencil in your left hand, the back of which should be towards the audience. Rub the inside of your left wrist with the other hand, explaining that this is to create “magnetic force”.

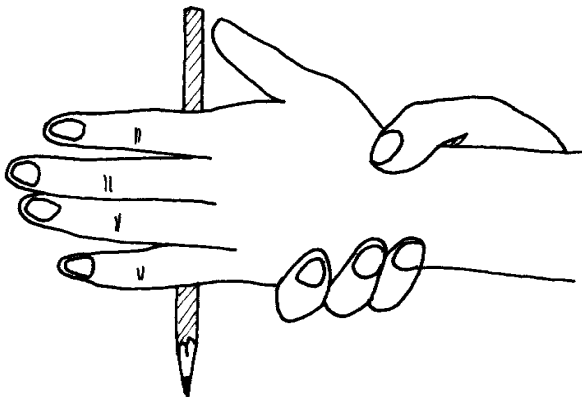

2. Suddenly open your fingers - and the pencil appears to be suspended without support.

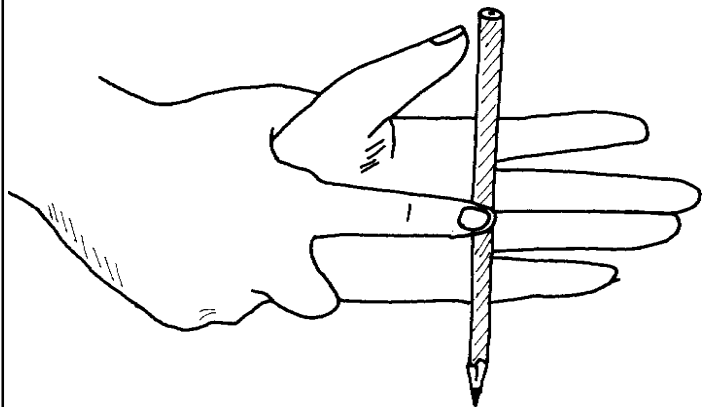

3. Actually you hold the pencil with the tip of your right forefinger, which your audience cannot see.

## RABBIT RACE

This rabbit race is easy and fun.

You will need 2 pieces of cardboard about 25-cm long, pencil, scissors, sketch pens and two 30-cm pieces of string.

Cut two rabbits from heavy cardboard, using the pattern shown in the picture. Colour the front and back of the rabbits using sketch pens. With a pencil make a hole through the middle of each rabbit just below the head. Make a neat hole with smooth edges. Tie a piece of string through the hole of each rabbit. Tie one end of each string to the leg of a table, just high enough so that the rabbit's legs touch the floor. Back up, taking the rabbits with you, to the end of the string. Make the rabbits stand up and lean a bit towards the table. When you jerk the string, the rabbits will walk towards the table. These rabbits walk best on a smooth floor. The first rabbit to reach the table wins!

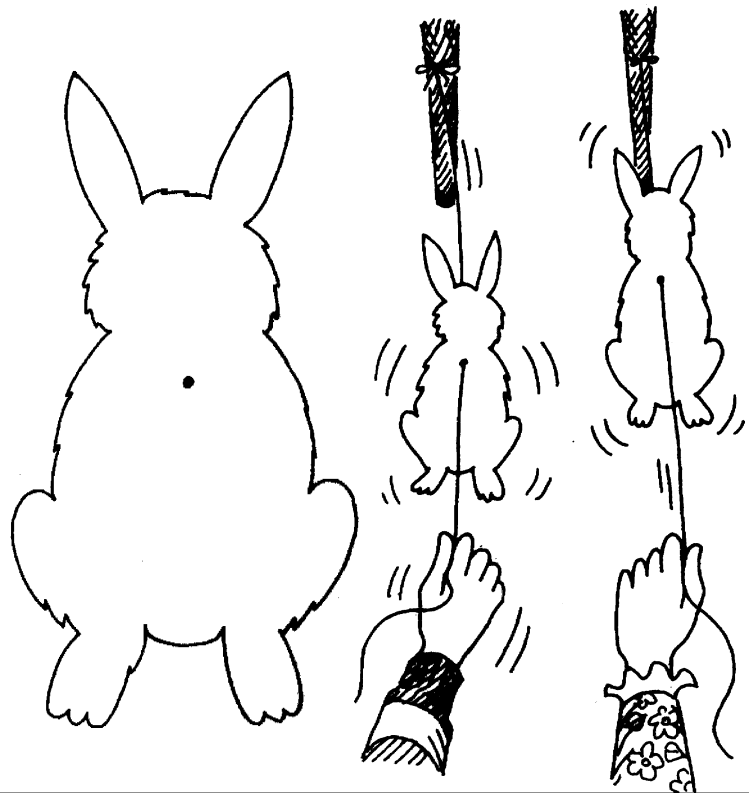

## SWINGING NUTS

What happens when two similar nuts swing? What happens if one is heavy and the other is light?

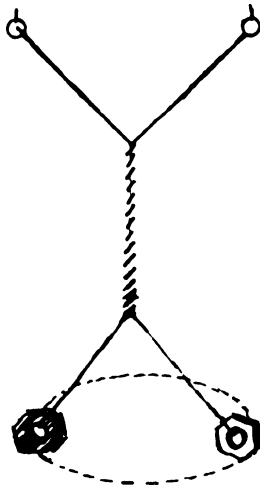

1. Hang two weights on strings and start them swinging around one another. How long will the weights keep winding up and unwinding?  
The two equal weights will continue moving for a long time, depending upon how heavy they are and the length of the strings.

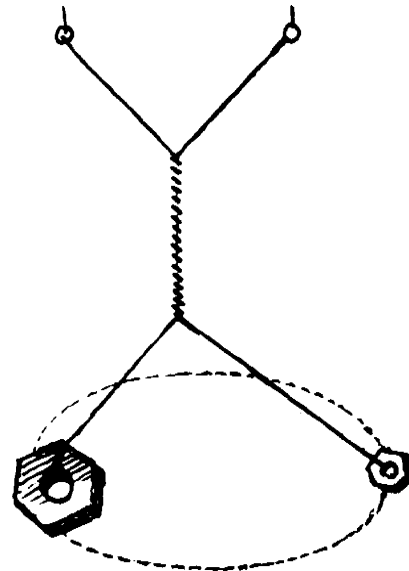

2. Next change one of the weights so it is heavier than the other one. Do the weights still wind and unwind the same way?  
The smaller weight swings in a circle around the string of the heavier weight while the heavier weight moves slowly back and forth like a pendulum.

## PAPER CUP RACE

You will need a large cardboard box, scissors, sketch pens, paper cups, table, tape and string.

Poke a hole in the bottom of two paper cups. Make colourful designs on them using sketch pens. Place a cardboard box (minus the lid) on the side of a table. Make sure the open end is several centimetres away from the edge of the table. Tape a length of string to the top of the left side of the box. The string should be long enough so that it reaches the table edge. Thread a paper cup onto the string, with the open part facing you. Tape the other end of the string to the table edge. Similarly, place another string and cup on the right side. Now the race can start! The cups should be resting on the table edge with the openings facing you. At the count of 3 blow into the cups, and see who can make their cup reach the top of the box first.

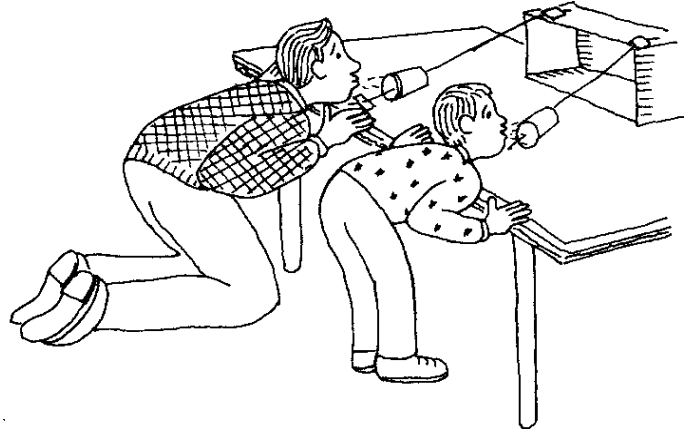

## CARD CUPBOARDS

Fold a rectangular card sheet in half. Make cuts in the margin and insert shelves. Later trim the corners of the shelves and make the cupboards stand.

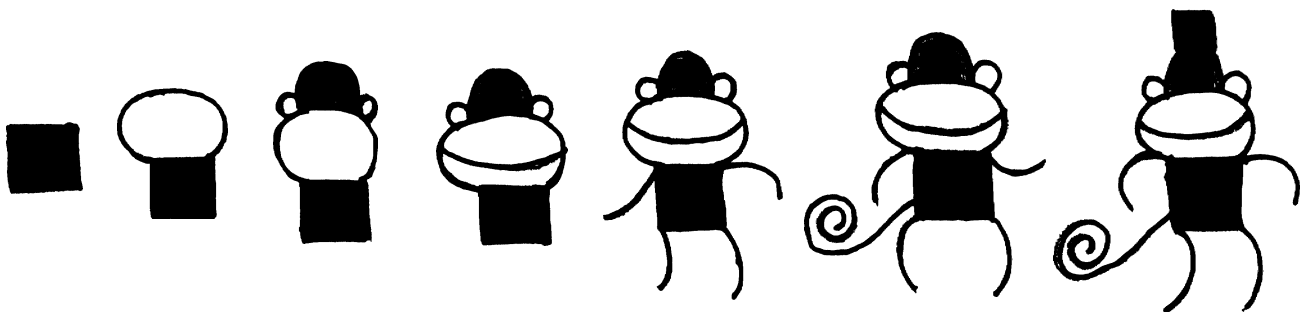
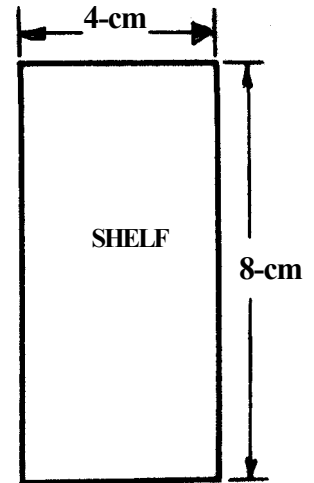
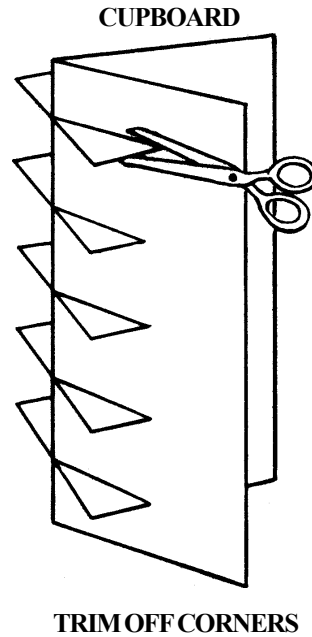
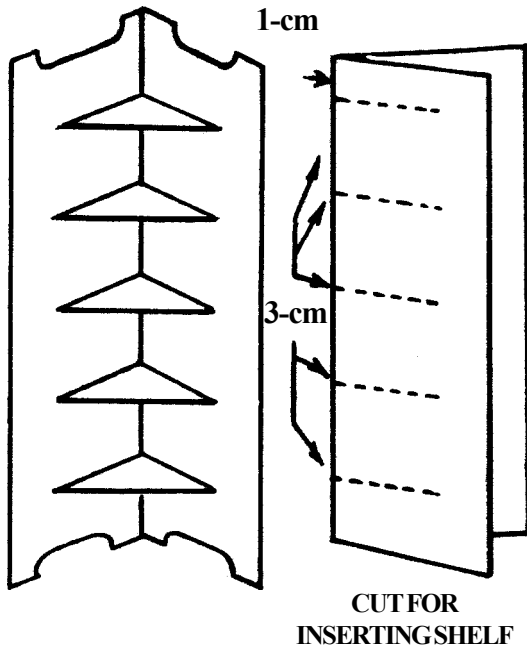



# STAND-UP ANIMALS

The stand-up animals on these pages can be made using lightweight stiff cardboard.  
Trace the pattern given on these pages. Cut carefully and then fit the parts together.  
Each animal will stand alone. Later you can colour the animals

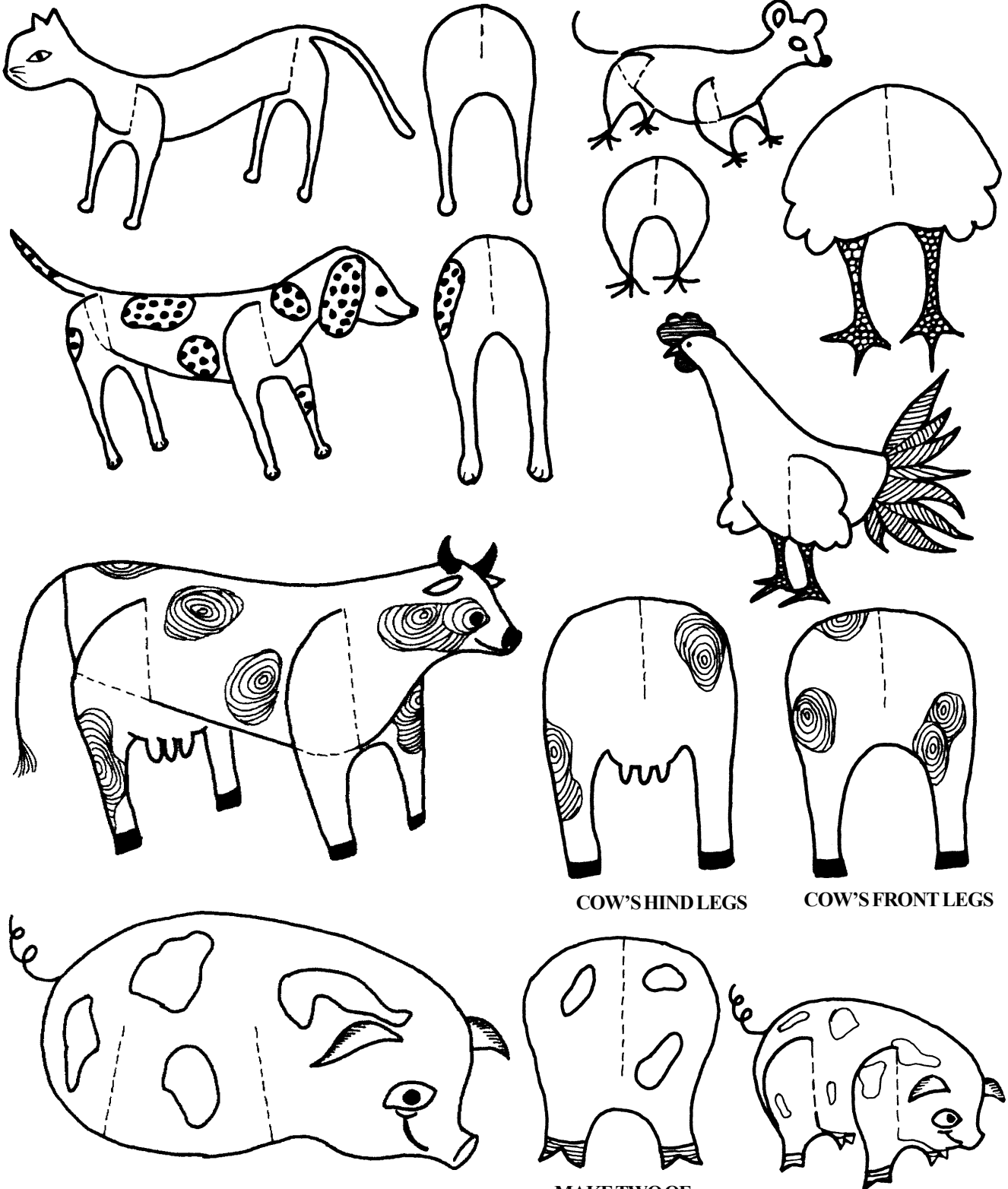

COW'S HIND LEGS

COW'S FRONT LEGS

CUT ALONG DOTTED LINES

MAKE TWO OF THIS PATTERN

## THE LADY WHO LOVED HER LIBRARY

Alia saved the 1000 year old precious library of Basra, Iraq.

Basra is the second biggest city of Iraq. Alia is the chief librarian of the Basra Central library. Alia inculcated a love for books as a child. She learnt a great deal about her own country and the big wide world from books. As a librarian, she shared her love for books with all the people of Basra. The library had a rich collection of over 40,000 books. Some of the books were very old and priceless. Alia's library was the meeting place of all those who loved books. Students, intellectuals and political activists thronged the library. They held meetings and discussions in the library.

In 2003, the combined forces of U.S.A. and U.K invaded Iraq - ostensibly to rescue it from the dictatorship of Saddam Hussein. The invasion of Iraq reached Basra on April 6, 2003. The news of war spread like wild fire. Alia could hear war planes roaring up in the sky. She was worried about the safety of her library - with all the precious books. She approached the office of the Mayor of Basra. She pleaded with them to remove the books to a safe destination. But the officials showed total disinterest and turned her away.

What could Alia do? In the face of official apathy Alia tried to do something on her own. Everyday she would stay back after work and pile books in her car boot and on the backseat and cover them with a carpet. She would bring the books home. Her husband would help in unloading the books. Soon their house was full of books.

The government stationed many soldiers and officials in the library. But as clouds of war began to gather and anti-aircraft guns began to boom the government servants ran away and abandoned the library. There was no one left to take care of the library.

There was general chaos in the city. People started looting shops. There was no one to guard the library. When Alia reached the library she was shocked to see most of the furniture and carpets gone! But fortunately not a single book was stolen.

Alia rung her old friend Anis Muhammad who ran the best restaurant in Basra, and asked for urgent help. Anis was a very sensitive man and he understood the value of the precious library. He immediately sent all his staff with empty sacks, cartons, table cloth covers etc. to pack the books. The team worked overtime all through out the night to shift the books and hid them in Anis's restaurant.

Nine days later the Basra Central library caught fire and burnt to ashes. A few days later - on a calm day Alia hired a truck and moved all the books from Anis's restaurant to the houses of her many friends and neighbours. She was happy that with her tireless struggle and the help of many friends she was able to save more than 30,000 precious books.

Soon after the library was destroyed Alia suffered a stroke and had heart surgery. She is slowly recovering and dreaming to rebuilt the library of Basra.



## BOYLE'S BALLOON

In the mid 1600's, Robert Boyle observed that in an ideal gas the product of the pressure and volume are nearly constant ( $pV = \text{constant}$ ).

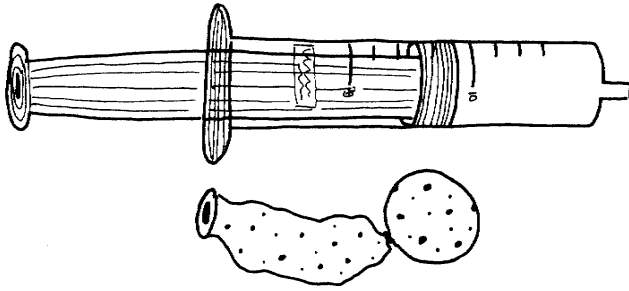

1. Take a large (30-40 ml) disposable plastic syringe. Remove its plunger. Blow a small 1-cm diameter baby balloon.

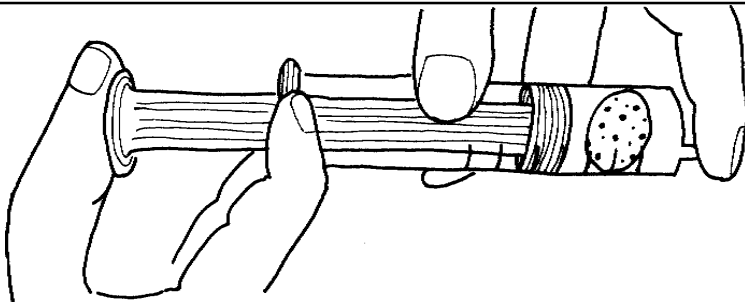

2. Put the baby balloon in the syringe tube. Insert the plunger. Close the nozzle of the tube tightly with your left finger and push the plunger slowly with the right thumb. The baby balloon will slowly shrink in size. This shows that as the pressure increases inside the balloon its volume decreases.

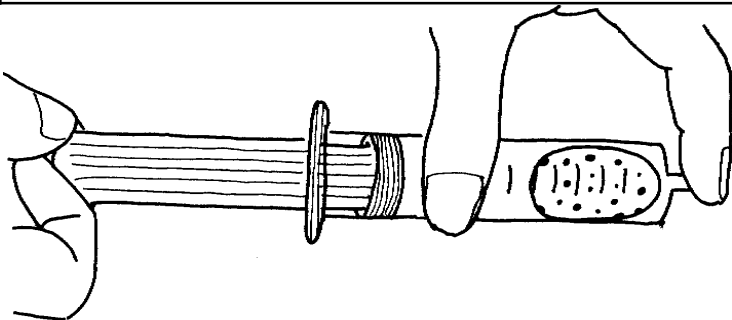

3. Now keep the nozzle closed and slowly retract the plunger. The baby balloon will slowly expand. This shows that as the pressure in the balloon decreases, its volume increases.

## MANY SIGNS, ONE SUN

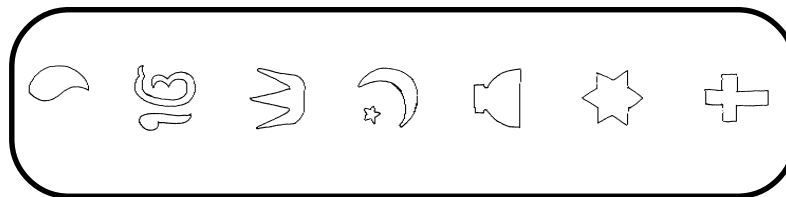

Take a card sheet and carefully cut out the symbols marked on it with a sharp knife. Go outside in sunlight and hold the card close to the ground. Examine the shadow cast by the card. You will see the various signs on the card projected on the ground. Now slowly raise the card towards the sun as high as possible. The different signs all become the same. They all become circles of light, circles of our broader understanding. As you go higher, the circles touch each other, an expression of unity, of coming together, of our essential oneness as human beings and earth citizens.

Why does this happen? This is not a miracle. It is based on the science of optics. The circles of light that you see are all the images of the sun. Therefore, "Many signs, One sun". They are round because the sun is round. This effect can also be seen in a the pinhole camera.

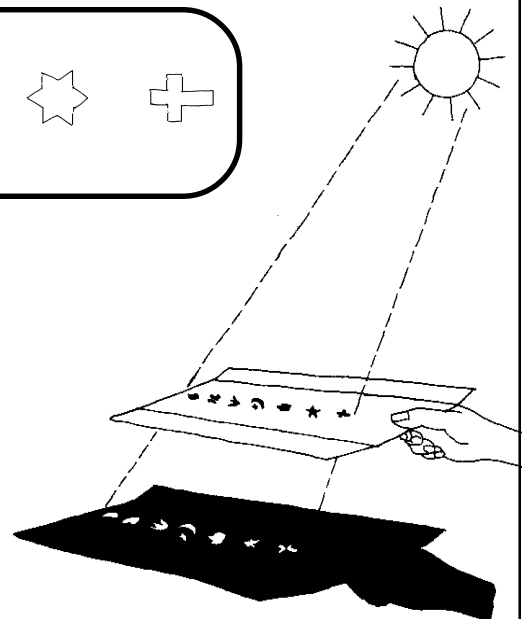

Courtesy - Dr. Vivek Monterio

## CONTINENTAL JIGSAW

If the continents were pieces of a jigsaw puzzle...this is how they would fit together.  
Most scientists think that 200 million years ago all the continents were originally one huge landmass.  
Slowly they broke up and drifted apart.

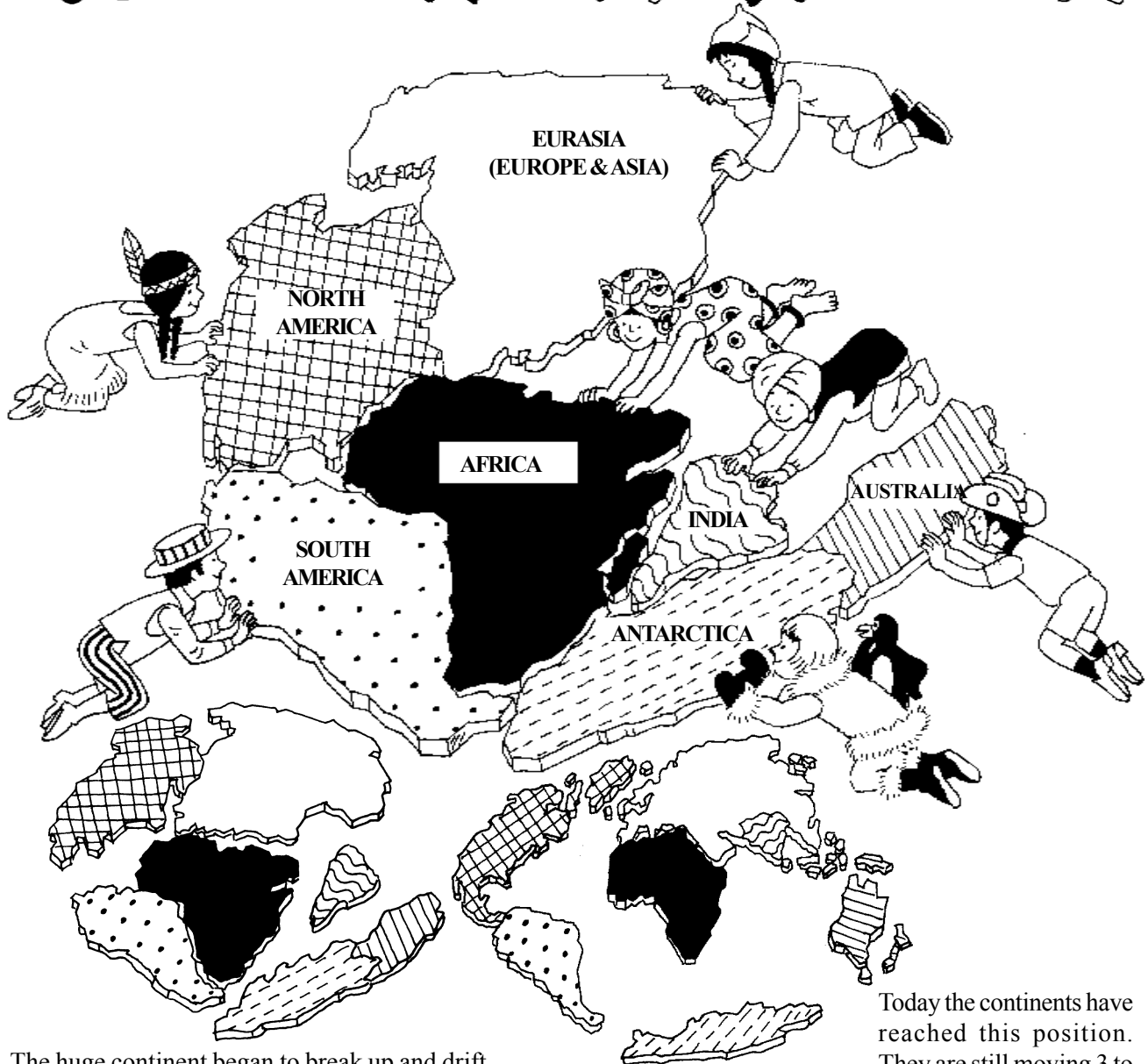
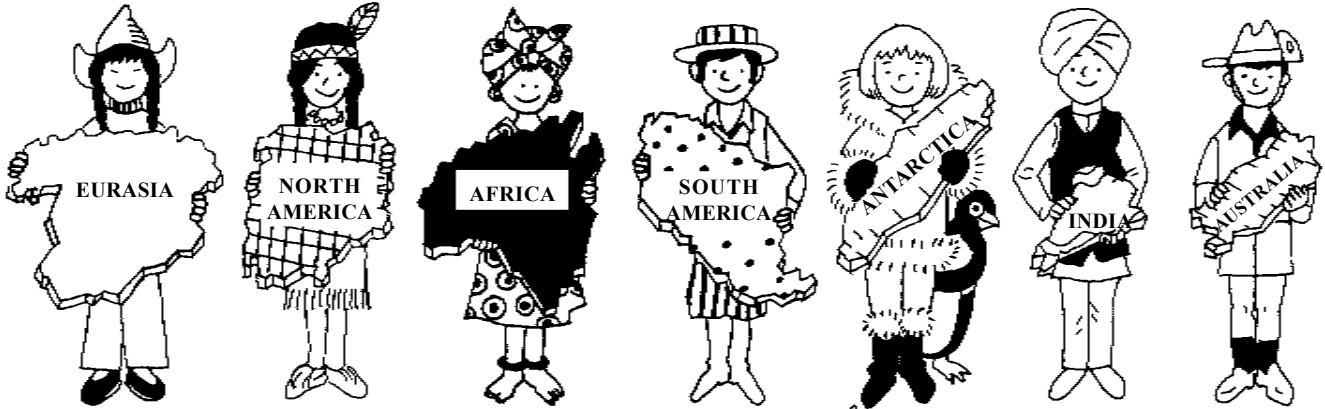

The huge continent began to break up and drift apart. This is the earth 135 million years ago.

Today the continents have reached this position. They are still moving 3 to 16-cm per year.

## FINGER STRETCHING

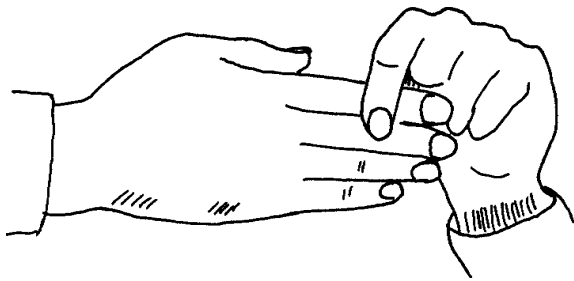

1. The trick: take hold of your right forefinger with your left hand and ...

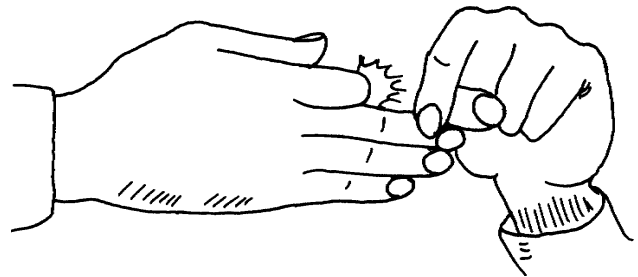

2. ....break off the end!

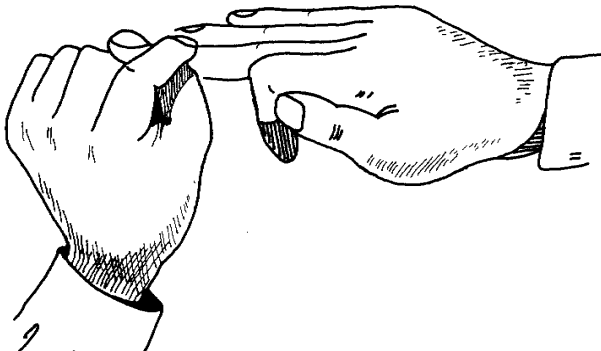

3. The facts: in step 1, your right forefinger is hidden and your left thumb, tucked behind one finger, is what your audience sees as your right forefinger.

Rest your left forefinger against the fingers of your right hand and, in Step 2, slide your left hand just 2 or 3-cm to the left. Slide it back again to “mend” your finger.

## RUNAWAY THUMB

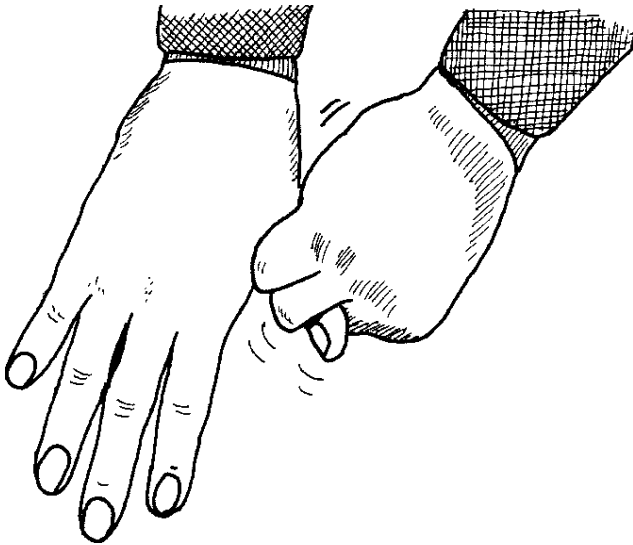

1. The trick: your left hand grasps the thumb of your right hand. You bend it back and forth and with a great deal of effort.....

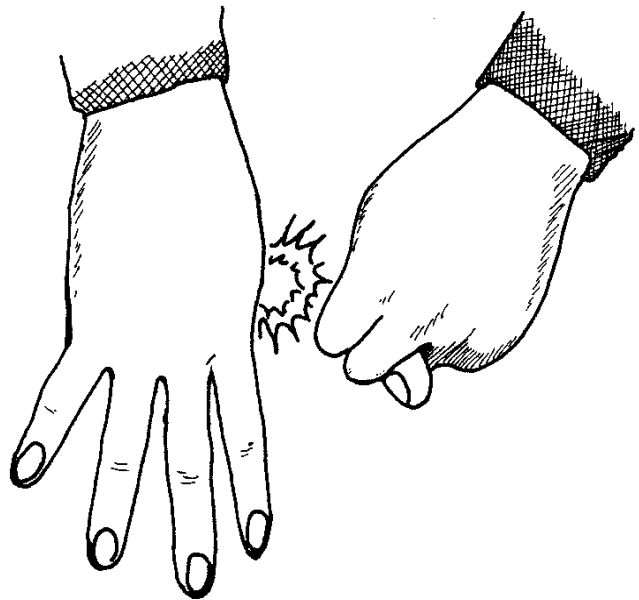

2. ....you pull your thumb right off!

The fact: in step 1, the thumb of your right hand is hidden in your right palm; and the thumb on view is the thumb of your left hand.

In step 2, do not bring your hands much more than 1 or 2-cm apart. Then return your thumb to “mend” your hand.

## SEVEN SECRETS OF SUCCESS

The answers were right there in my room!



1. Roof said:  
**AIM HIGH**

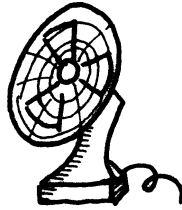

2. Fan said:  
**BE COOL**

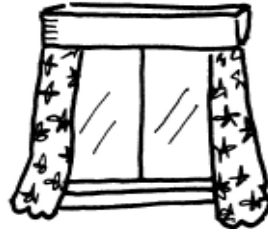

3. Window said:  
**SEE THE WORLD**

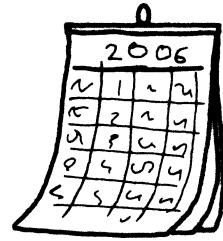

4. Calendar said:  
**BE UP TO DATE**

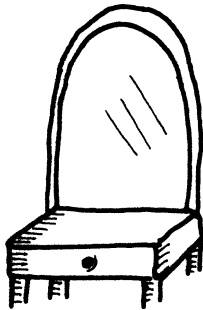

5. Mirror said:  
**REFLECT BEFORE  
YOU ACT**



6. Clock said:  
**EVERY MINUTE IS  
PRECIOUS**

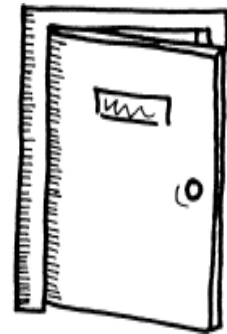

7. Door said:  
**PUSH HARDER TO  
ACHIEVE YOUR GOAL**

## WHEEL OF MEASURE



1. You will need measuring tape, pencil, a stiff paper plate, ruler with a hole on one end, and a split pin type of paper fastener.

2. Use the tape to mark off the centimetres around the paper plate. Attach the middle of the paper plate to the ruler with a paper fastener. Run your measuring wheel along any surface to see how long the surface is in centimetres. Count how many times the wheel goes from one end of the surface to the other, and multiply it by the number of centimetres you marked on the wheel. For example, did you mark off 25-cm on the wheel? If a 25-cm wheel goes around 5 times from one end of the table to the other, then the table is 125-cm long. Find out how long or wide things are - like the width of the door, the length of the room etc.

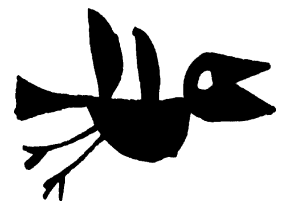
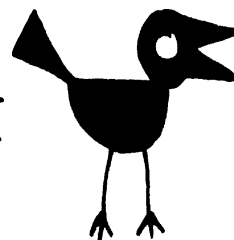

## ONLY TEACHING

A young man said that he wished to do some good work for society.

“Tell me,” I said, “what kind of work do you feel you could do well?”

“Only teaching, I think,” replied the young man. “I can’t do anything else, I can only teach, but I am interested in it and I feel sure that I shall be able to do it well.”

“Yes, yes, I do not doubt that, but what are you going to teach Spinning? Carding? Weaving? Could you teach any of these?”

“No, I can’t teach those.”

“Then tailoring, or dyeing, or carpentry?”

“No, I know nothing about them.”

“Perhaps you could teach cooking, grinding, and other household skills?”

“No, I have never done any work like that. I can only teach...”

“My dear friend, you answer ‘No’ to every question, and yet you keep saying you can only teach. What do you mean? Can you teach gardening?”

The would-be teacher said, rather angrily, “Why do you ask all this? I told you at the beginning, I can do nothing else. I can teach literature.”

“Good! Good! I am beginning to understand now. You mean you can teach people to write books like Tagore and Shakespeare?”

This made the young man so angry that he began to splutter.

“Take it easy,” I laughed. “Can you teach patience?”

That was too much.

“I know what you mean,” I said. “You can teach reading, writing, history, and geography. Well, they are not entirely useless, there are times in life when they are needed. But they are not basic to life. Would you be willing to learn weaving?”

“I don’t want to learn anything new now. Besides I couldn’t learn to weave, I have never before done any kind of handwork.”

“In that case it might, of course, take you longer to learn, but why should you be unable to learn it?”

“I don’t think I could ever learn it. But even supposing I could, it would mean a lot of hard work and a great deal of trouble. So please understand that I could not undertake it.”

This conversation is quite enough to enable us to understand the psychology and characteristics of far too many of our “teachers.” To be “only a teacher” means to be: completely ignorant of any kind of practical skill which might be useful in real life; incapable of learning anything new and indifferent towards any kind of craftsmanship; conceited; and buried in books. “Only teaching” means being a corpse cut off from life.



## ACROBAT

A very simple and dynamic model. When the toy is spun the arms and legs of the acrobat fly in the air - demonstrating centrifugal force.

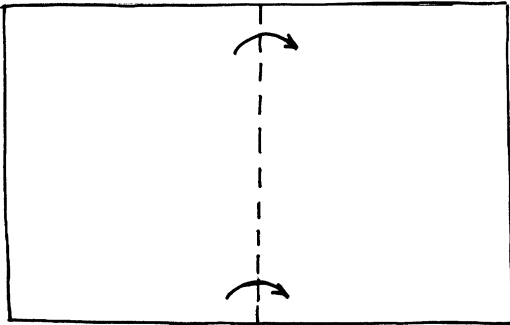

1. Take a thick card sheet 30-cm x 15 cm. Fold it in half.

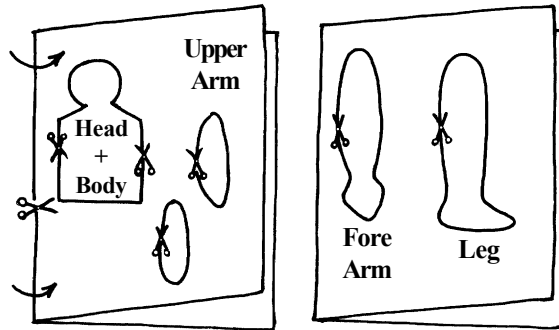

2. Draw a head and body, two forearms, one arm and leg as shown.

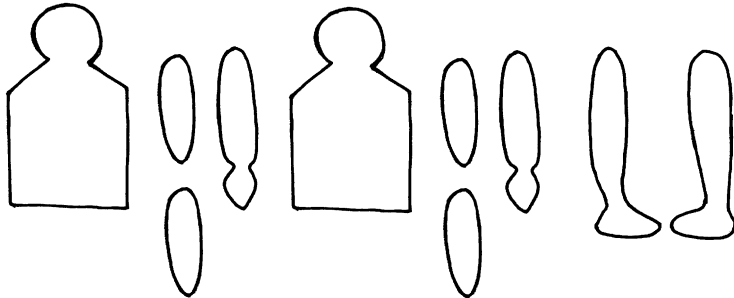

3. After cutting these there will be 10 pieces as shown in the picture.

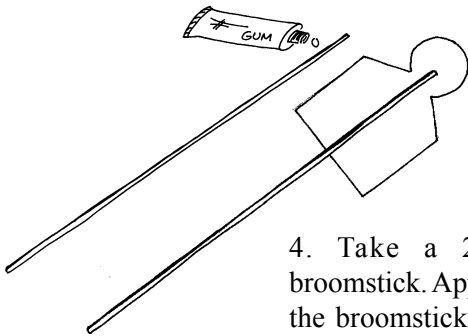

4. Take a 25-cm strong broomstick. Apply glue only on the broomstick. Stick it in the middle of one head and body.

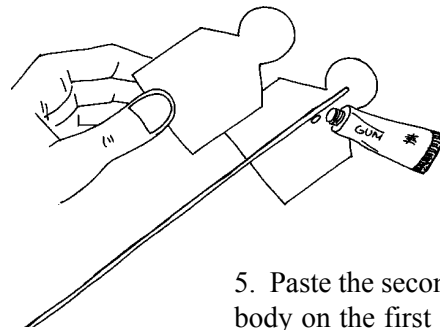

5. Paste the second head and body on the first (apply glue only to the broomstick).

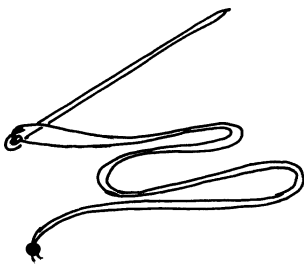

6. Weave a doubled thread through a long needle and tie a knot.

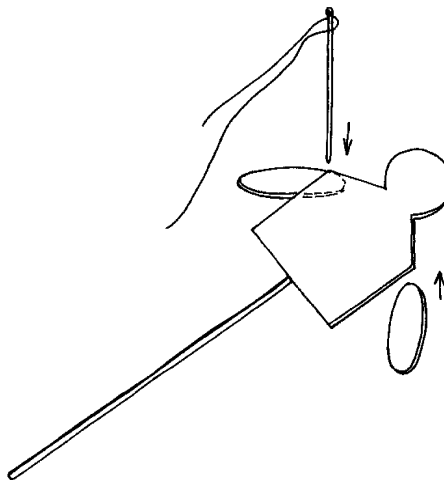

7. Take two upper arms and place them in between the left shoulder and sew. Do the same for the right shoulder.



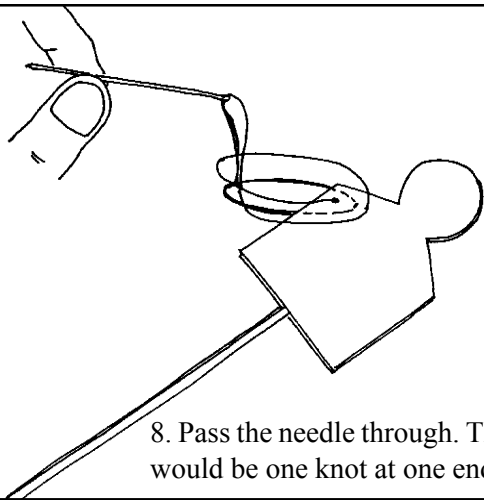

8. Pass the needle through. There would be one knot at one end.

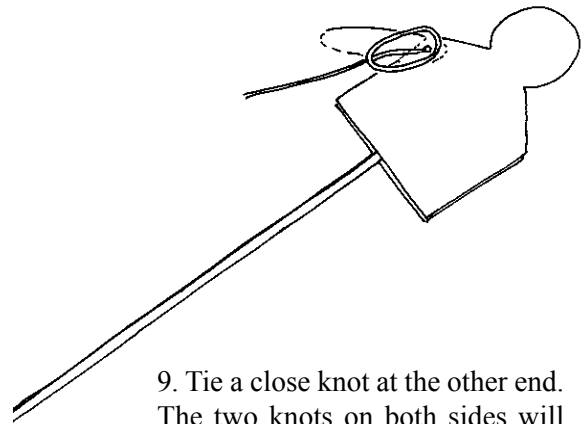

9. Tie a close knot at the other end. The two knots on both sides will make a nice movable hinge.

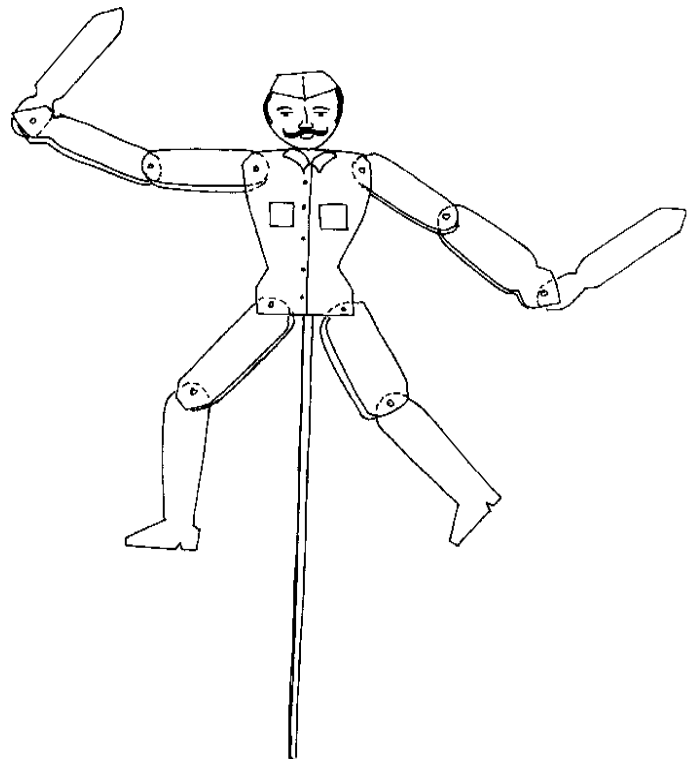
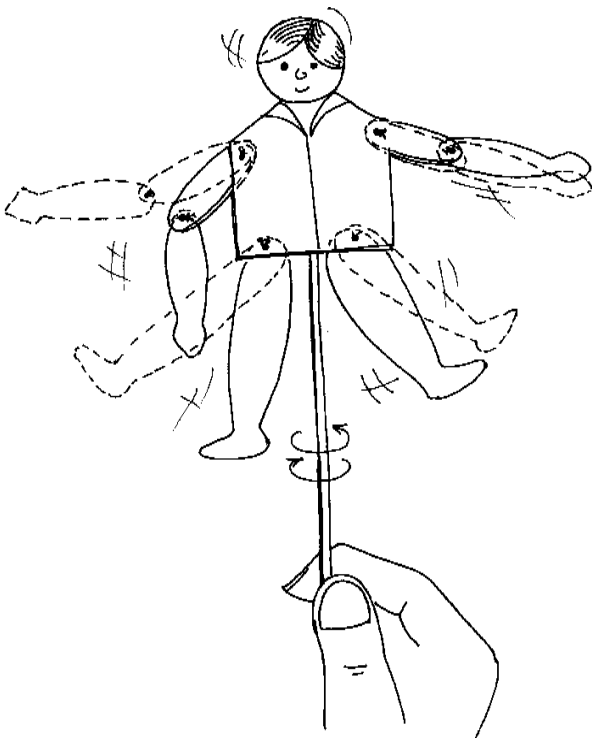

10. Similarly, attach the forearms and legs (one piece each), with thread hinges. The acrobat will now be ready to perform. Hold the broomstick between the thumb and index finger. Twirl the broomstick. The acrobat will wildly swing its arms and legs. Make creative variation in this dynamic puppet.

### WHIP-CRACK

Here are two simple ways of making a whip-crack using soda straws.

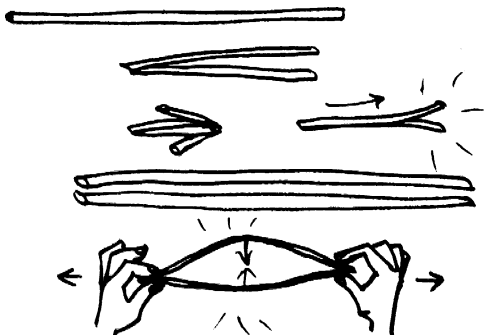

1. Flatten the straw and bend back the ends. Holding the straw, run a finger and thumb sharply along it in the direction of the arrow, so that the ends crack together.

2. Flatten two straws, holding the ends, bow the centres apart, and pull them smartly together to make a cracking sound.

## MIRROR IMAGES

A line of symmetry divides a figure into two halves. They fit exactly on each other if folded along the line. Here a few simple experiments which you can do with a simple mirror.

1. Which of these two diagrams show mirror symmetry?  
Will the two halves match if the picture is folded along the dotted line?

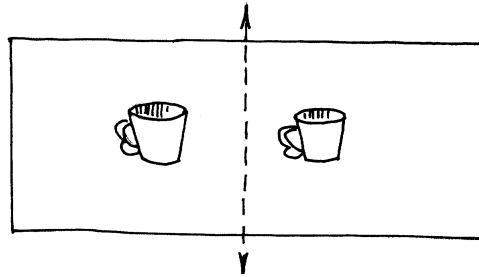
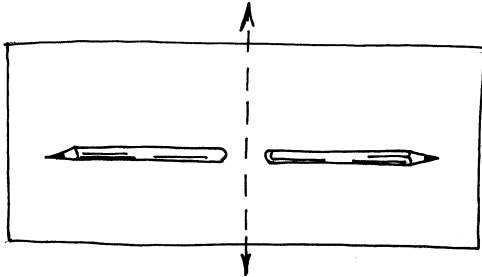

2. Which of these two diagrams show mirror symmetry? Why?

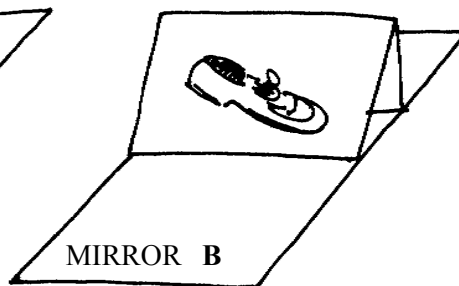
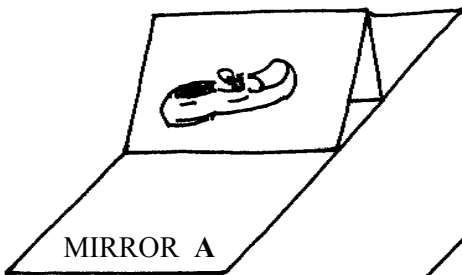
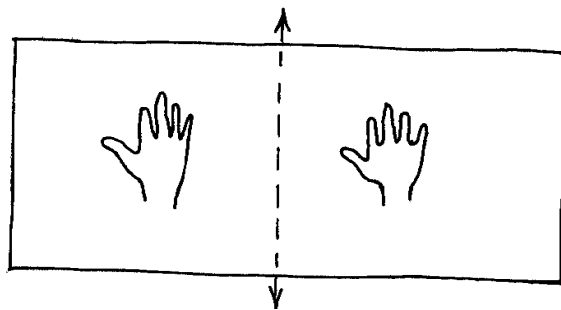
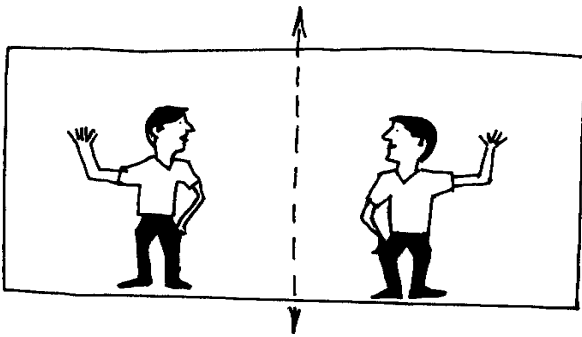

3. A and B are mirrors. Draw the images of the shoes on the mirrors.

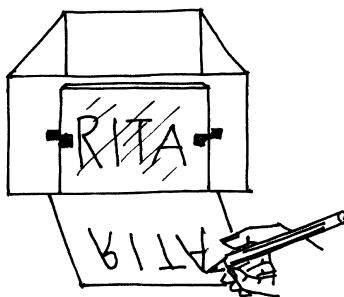

4. Write your name on the paper so that the image in the mirror looks correct.

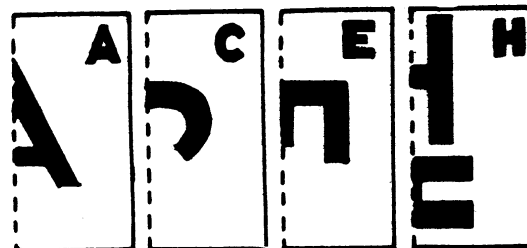

5. Here are a few patterns for cutting out letters. These patterns also depict the axis of symmetry.

## REFERENCES

1. **The Third Book of Experiments**, Leonard De Vries, Carousel Books
2. **More Brain Boosters**, David Webster
3. **Bet You Can't!**, Vicki Cobb, Lothrop, Lee & Shepard Books, New York
4. **Fermat's Last Theorem**, Simon Singh, Fourth Estate, London
5. **Origami for Beginners**, Robert Harbin, Hodder and Stoughton
6. **Turning the World Inside-Out**, Robert Ehrlich, Princeton University Press, New Jersey
7. **Science Works**, Ontario Science Centre, Ontario
8. **Anno's Magic Games**, Matsumasa Anno, Philomel Books, New York
9. **Toying Around with Science**, Bob Friedhoffer, Franklin Watts, New York
10. **The Historian's Toybook**, E. P. Provenzo, A.B. Provenzo, P. Zorn, Prentice-Hall
11. **The Science Explorer**, P. Murphy, E. Klages, L. Shore, An Owl Book
12. **Finges, Knuckles and Thumbs**, Eric Kenneway, Beaver Books
13. **What Every Uncle (or Aunt) Should Know**, Avon Books, New York
14. **Tricks and Games with Paper**, Paul Jackson, Angus & Robertson.
15. **1,001 Uses of the Hundred Squares**, Leah Mildred Beardslay, Parker Publishing Co
16. **Match Play**, Peter Eldin, Granada, New York
17. **Making Things**, Ann Wiseman, Little Brown & Co, Boston
18. **Paper Shapes**, Eric Kenneway, Beaver Books
19. **Big Book About Earth and Space**, Joe Kaufman, A Golden Book, New York
20. **Pop - Ups**, Paul Jackson
21. **Obedience to Authority**, Stanley Milgram
22. **The Paper Aeroplane Book**, Seymour Simon
23. **Learning from Gandhi**, Anu Bandopadhyaya, Other India Bookstore, Mapusa, Goa 403507
24. **Tricks, Games & Puzzles**, Maxey Brooke, Dover Publications, New York
25. **King of Children**, Betty Jean Liffon
26. **700 Science Experiments for Everyone**, Compiled by UNESCO, Doubleday
27. **100 Amazing Science Fair Projects**, Glen Vecchione, Goodwill Publishing House, New Delhi
28. **ABC Zoo**, Detlef Kersten
29. **The Maths Pack**, Ron van der Meer & Bob Gardner, Johnathan Cape Random House, London
30. **Make your own Toys & Games**, Hal Danby, Armada, London
31. **365 Simple Science Experiments with Everyday Materials**, Richard Churchill, Sterling Publishers
32. **The Book of Experiments**, Leonard De Vries, Carousel
33. **The Rubber Band Book**, Eric Kenneway, Beaver Books, London
34. **Joy of Learning** (Standards 3 to 5) Center for Environmental Education, Ahmedabad, India
35. **Experiments for you**, John Tollyfield, Evans Brothers, London
36. **How to Turn Water Upside-Down**, Ralph Levinson, Beaver Books, London
37. **Experiments with Everyday Objects**, Kevin Goldstein-Jackson, Granada Publishing, New York
38. **Math Teasers**, Robert Muller, Sterling Publishing Inc. New York
39. **Broca's Brain**, Carl Sagan, Ballantine Books, New York
40. **Eye Teasers - Optical Illusion Puzzles**, Charles H. Paraquin, Granada
41. **Simple Science Experiments**, Batstord, Hans Jurgen Press
42. **Let's Discover Science**, David Horsburgh, Oxford University Press
43. **365 Holiday Crafts & Activities**, Lisa Lerner, Kersten Hamilton, Publication International Ltd

## SUGGESTED BOOKS ON EDUCATION, SCIENCE & MATHS

1. **Divasvapna**, Gijubhai Badheka (English, Hindi & other Indian languages) National Book Trust, New Delhi 110016
2. **Totto-chan**, Tetsuko Kuroyangi (Hindi & other Indian languages) National Book Trust, New Delhi 110016
3. **Chai Ki Pyali Mein Paheli**, Partho Ghosh & Dipankar Home (Hindi) National Book Trust, New Delhi 110016
4. **The Child's Language & the Teacher**, Krishna Kumar (Eng / Hin) National Book Trust, New Delhi 110016
5. **Raj, Samaj Aur Shiksha**, Krishna Kumar (Hindi) Rajkamal Prakashan, Daryaganj, New Delhi 110002
6. **The Blackboard Book**, Eleanor Watts (Eng /Hin) Orient Longman, 3-5- 820, Hyderguda, Hyderabad 500029
7. **Romping in Numberland**, P. K. Srinivasan, National Book Trust, New Delhi 110016
8. **Guess Where am I?** *Accu* Book, National Book Trust, New Delhi 110016, nbtindia@ndb.vsnl.net.in
9. **UNESCO Sourcebook for Science in the Primary School**, Harlen & Elstgeest, National Book Trust, New Delhi 110016
10. **Soap Bubbles**, C.V. Boys, (E / H) Vigyan Prasar, C-24, Qutub Institutional Area, New Delhi 110016
11. **The Chemical History of a Candle**, Michael Faraday (Eng/Hin) Vigyan Prasar, New Delhi, info@vigyanprasar.gov.in
12. **My Friend Mr. Leakey**, J.B.S.Haldane, Vigyan Prasar, New Delhi , info@vigyanprasar.gov.in
13. **Everything has a History**, J.B.S.Haldane, Vigyan Prasar, New Delhi, info@vigyanprasar.gov.in
14. **Science in Everyday Life**, J.B.S.Haldane, Vigyan Prasar, New Delhi, info@vigyanprasar.gov.in
15. **Khulte Akshar, Khilte Ank**, Vishnu Chinchalkar (Hindi) National Book Trust, A 5, Green Park, New Delhi 110016
16. **How Children Fail**, John Holt (Hindi) Eklavya, E7- 453, Arera Colony, Bhopal, 462016, books@eklavya.in
17. **Instead of Education**, John Holt (English) Other India Bookstore, Mapusa, Goa 404507, oib@goatelecom.com
18. **The Underachieving School**, John Holt (Hindi) Eklavya, Bhopal, books@eklavya.in
19. **Escape from Childhood**, John Holt (Hindi) Eklavya, Bhopal, books@eklavya.in
20. **VSO Science Teacher's Handbook**, Andy Byers, Ann Childs, Chris Lane (Hindi) Eklavya, Bhopal, 462016
21. **VSO Maths Teacher's Handbook** , Jane Portman, Jeremy Richardson (Hindi) Eklavya, Bhopal, 462016
22. **Summerhill**, A.S. Neill (Hindi) Eklavya, E7- 453, Arera Colony, Bhopal, 462016,books@eklavya.in
23. **Duishen**, Chingez Aitmatov (Eng /Hin) National Book Trust, New Delhi 110016, nbtindia@ndb.vsnl.net.in
24. **Lives of Children**, George Dennison (Hindi) Granth Shilpi, G-82, Vijay Chowk, Laxmi Road, New Delhi 110092
25. **Learning from Gandhi**, Anu Bandopadhyaya, Other India Bookstore, Mapusa, Goa 404507, oib@goatelecom.com
26. **Teacher**, Sylvia Ashton Warner, available from Arvind Gupta email: arvindguptatoys@gmail.com
27. **Thumbprints**, Arvind Gupta, Vigyan Prasar, New Delhi, info@vigyanprasar.gov.in
28. **Environment & Self-Reliance**, Yona Friedman, Eda Schaur (Eng/Hin) Vigyan Prasar, New Delhi
29. **Energy & Self-Reliance**, Yona Friedman (Eng/Hin) Vigyan Prasar, New Delhi, info@vigyanprasar.gov.in
30. **The Story of Physics**, T. Padmanabhan (Eng/Hin) Vigyan Prasar, New Delhi, info@vigyanprasar.gov.in
31. **On the Various Forces of Nature**, Michael Faraday, Vigyan Prasar, New Delhi, info@vigyanprasar.gov.in
32. **The Insect World of J. Henri Fabre**, Vigyan Prasar, New Delhi, info@vigyanprasar.gov.in
33. **The Autobiography of Charles Darwin**, Vigyan Prasar, New Delhi, info@vigyanprasar.gov.in
34. **Number Fun with a Calendar**, P. K. Srinivasan, Alarsri, Plot 5, Street 25, T. G. Nagar, Chennai - 600061
35. **Mahagiri**, Pulak Biswas (Eng / Hin) Children's Book Trust, Bahadur Shah Zafar Marg, New Delhi 110002
36. **Gayneck**, Dhan Gopal Mukerjee, National Book Trust, New Delhi 110016, nbtindia@ndb.vsnl.net.in
37. **From Bone to Stone**, Karen Haydock, National Book Trust, New Delhi 110016, nbtindia@ndb.vsnl.net.in
38. **The Joy of Making Indian Toys**, Sudarshan Khanna (Eng / Hin) National Book Trust, New Delhi 110016
39. **Samajh Ke Liye Taiyari**, Keith Warren (Hindi) National Book Trust, New Delhi 110016, nbtindia@ndb.vsnl.net.in
40. **The Bicycle Story**, Vijay Gupta, Vigyan Prasar, New Delhi, info@vigyanprasar.gov.in
41. **Aakash Darshan Atlas**, Gopal Ramchandra Paranjpe, NCERT, Sri Aurobindo Marg, New Delhi 110016
42. **Manual for Mathematics Teaching Aids for Primary Schools**, P.K. Srinivasan, C.I.E.T. NCERT, New Delhi 110016
43. **Resource Material for Mathematics Club**, P.K. Srinivasan, C.I.E.T. NCERT, New Delhi 110016
44. **Democratic Schools** - Ed. Michael W. Apple & James Beane, Eklavya, books@eklavya.in