

JOY OF MAKING INDIAN TOYS

SUDARSHAN KHANNA

This is a simple activity book meant for children as well as adults. Children make and play while adults help and guide. The 101- hand-made toys documented inside are the playthings made even today in various corners of India and at practically no cost at all. Besides providing hours of fun, this activity book helps to instill confidence by enabling children to create their own toys with their own skill and ingenuity. It is not surprising that such small, ordinary playthings have something to do with design, science and technology too?

Sudarshan Khanna is a Professor at the National Institute of Design, Ahmedabad, India. His other books, **Dynamic Folk Toys** and **Toys and Tales** have been acclaimed by educationists and designers as pace setters. He is recipient of the NCSTC -DST's National Award for Science Popularisation among Children. He is on the board of the International Toy Research Association (ITRA) and has conducted several workshops and exhibitions on various aspects of Indian toys and toy-makers.

Sudarshand Khanna can be contacted at khanna@nid.edu or toycentre@nid.edu

THE JOY OF MAKING INDIAN TOYS (Rs 40/- equivalent to US\$ 0.85 only) can be purchased from the National Book Trust, A-5, Green Park, New Delhi 110016, India.

The Hindi version of the above book - **SUNDAR SALONE, BHARTIYA KHILONE** can also be purchased from the above address at just Rs 35/-

This is a landmark book. Much before all the violent and sexist toys - Barbies, He Man and Skullman made their debut, Indian children made their own toys - largely from scrap and throw away materials. These toys would today be classified as 'ecofriendly' toys. Sudarshan Khanna is rightly called the Indian toyman. His single handed research - for over 30 years has put Indian toys on the world map. This book is above all a salute to the genius of Indian children - past and present - how an ancient civilisation learnt to do so much with so little. These are fun toys which even the poorest child on earth could afford. And unless all the world's children play with toys, there will be no peace on earth.

PREFACE

This simple, straightforward resource book has been prepared for two basic reasons: one reason stems from my belief that every society has a great deal of practical and useful knowledge which is often expressed most creatively and effectively through the tales and toys of that society; the other reason is based on my own experience with self-made simple toys. This gave birth to my interest and fascination for design, science and technology. Today we find children and their parents are obsessed with glossy, high-priced, factory-made toys, perhaps not realising what a child can gain from simple self-made playthings.

A few words on how this book was developed. It began with documentation of what I remembered about playthings I had made and played with during my childhood. Next I started a regular interaction with neighbourhood children. I often invited them to my house and made them play with new toys. The children in turn showed me things that they and their friends made and played with. The other source of information I drew upon was my students and faculty colleagues at the National institute of Design (NID). Being a national institute its students and faculty staff are drawn from all over the country. They were able to provide information on artisans, who came for training programmes at NID, provided the impetus to ideas on the playthings that were popular in their areas.

This process of interaction with children, with my students, faculty colleagues and craftsmen, went on for about four years and a good resource was built up during these years. The information collected covered the toys children made and played with throughout the country, not only t~ day but even a generation ago. I also had interesting discussions with designers, scientists and educationists. Their views, often divergent, helped me in shaping and processing the material collected for the book.

This is a revised and redesigned edition of the earlier book titled **Joy of Making Indian Toys**, first published in 1992.

ACKNOWLEDGMENTS

I am grateful to the following institutions and individuals:

The National Council of Science & Technology Communication (NCSTC), Department of Science and Technology, Government of India, for financial support towards the pre-publication testing of the book and to the United National Children's Fund (UNICEF) for providing financial assistance for development of the manuscript

Education and science consultants who reviewed the manuscript include Shri Arvind Gupta, engineer and people's science movement activist; Shri Arun Gohil, scientist; Dr Anwar Jafri, scientist and educator; Dr Anita Ramphal Raina, educationist and science researcher; Dr Krishna Kumar, educationist.

Shri Tarun Deep Girdher, student of communication design at NID, redesigned the book and page layouts under the guidance of Shri S.M. Shah, also of NID. The illustrations were redrawn by Shri Ranjit Balmuchu and Shri Tarun Deep Girdher. The text was re-edited by Ms Poomima Burte and Ms Urmila Mohan, also of NID.

Ms Jayshree Mehta, Ms Anjana Bhagwati and Shri K.P. Janardan, scientists of VASCSC, conducted a comprehensive evaluation study on the pre-testing of this publication. The NID provided all necessary help and support. consistent support, encouragement and keen interest in the development of this book.

The National Book Trust (NBT) deserves special credit for quality production of this book at an economical price, reflecting its genuine concern for the readers, and for publishing this work in almost all the major Indian languages.

I am thankful to the many children and others who contributed to this work in their own special way and yet remain unnamed.

INTRODUCTION

The best thing a child can do with a toy is to break it; the next best he can do is to make it. This book is on toys which children can make and break freely. The low- cost or rather no-cost toys are the everyday playthings used by millions of children today as also in the past.

The fact that these-toys cost nothing and are made of the simplest materials, often that is recycled, does not mean that they are inferior to the high-priced, factory made, easily available off-the-shelf toys. In all possibility these hand made toys have an edge over the commercially produced playthings. You may ask how it is so? Let us read further to find out this.

Learning by 'experimentation' and 'creative activity'

One of the unique features of these toys is that they introduce children to a scientific method of working. In the process of making and playing with these toys, their faults and shortcomings can be realised easily. This is so because, unless the toys are made according to certain specifications, they will either not work at all or work improperly. Children on their own can make changes and remove the shortcomings, if any. For instance, when a paper whistle is made and no sound emanates, children become curious and wonder: is the construction the children are introduced to the basic ideas of 'experimentation' and 'creativity' in a subtle yet effective manner.

Learning from each other

The toys shown in this book are made by the children themselves. They may have learnt these either from their peers, or from older children or from adults. In the process they tend to share and learn. At times, guidance may be sought from elders on how to make and play with the toys.

Seedlings of science and technology

It would be fair to say that no other type of toys can introduce children to the basics of science and technology so effectively as these handmade ones. A child effortlessly gets exposed to the principles of science, particularly those of physics.

It may be argued that the fundamentals of science can be explained by means of scientific equipment and appliances and also through examples from our own environment. So what is special about knowing science through these toys? Well, these toys, being simple to make and easy to play with, provide a clearer concept of science. Learning becomes a part and parcel of the play and a joyful experience at that.

You will come across the helicopter under Section 3. This is made of a wooden ruler tied at one end with a piece of string. It does not look like a helicopter. But wait. Hold the free end of the string and swing the ruler in the air. Something unexpected happens: a strange growling sound emanates as that of a helicopter approaching. A child is bound to be curious about how a simple ruler can generate such an unusual sound.

These toys introduce the child to the fundamentals of technology besides showing how to plan and construct step by step; work with common basic tools such as a knife, pair of scissors, hammer, etc.; use a variety of materials and thus get familiar with their properties; understand the basic concepts of measurements and the need for accuracy; appreciate the 'part and assembly' concept, i.e. how an object having more than one part is made by assembling parts which have been made separately; and evaluate the work done and judge the scope for improvement.

Introduction to 'design'

Take the case of the windmill toy under Section 3. The aim is to make a playing device which can rotate by wind energy. This toy is developed by selecting the right materials and through appropriate structural construction. Let us suppose that the paper used for this windmill is too thin or too thick or the paper blades are not in balance or do not have the correct type of folds. Will this toy work? Likewise, how does a new user know that this toy would rotate against the wind current? Does the form indicate this? Very often children paint colourful rings on the blades to perhaps indicate rotary action and to enhance the visual appeal.

There are also toys which tell us something about 'design and nature'. For example, the ant and the fan machine in Section 2. As part of its design construction, a stick is inserted in a hollowed rubber-plant seed. On studying this seed-shell, no cut or breakage is visibly apparent. How is it within the seed without any cut on its shell? Well, what follows may seem like a fairy-tale. A child gets hold of a rubber-plant seed, and leaves the seed at an ant-hill for a day or two. Ants eat up the pulp within the seed and create a hollow. The child then collects the hollowed shell. This is something commonly done by children in Kerala state, where the toy is very popular. Is it not fascinating that 'common' people find out the most 'uncommon' and imaginative design solutions!

There are some other toys which familiarise a child to the innovative aspects of design science. One such example is described under Section 4. It is called the 'sewing machine'. This toy is extremely popular in the south where coconuts grow in abundance. The toy makes a slight 'tik-tik' sound, much like a real sewing

machine in operation. But there is another ingenious feature added which makes it still more interesting. A green leaf is placed in between the sticks and the toy is rotated. The 'tik-tik' sound is heard as expected. A new phenomenon is the displacement of the leaf and its falling down. On examining this leaf, small holes are seen. These holes look exactly like stitches, as if the leaf had been placed under the pressure foot of an actual sewing machine.

Some questions commonly asked are explained in detail in the following paragraphs.

Are these toys safe?

These toys are relatively safe considering the Indian home environment. Children usually make these from discarded materials by using tools such as knives, scissors, needles, etc. At what age should the child be allowed to handle these tools? Are these tools risky? On the contrary, the making of these toys provides an opportunity to handle materials and tools by taking adequate precautions when working. This is an important aspect of growing up. However, in the making of certain toys there is always an element of risk. For example, there are toys which involve the use of a razor blade or bows and arrows. Here teachers and guardians need to warn the child against accidents, yet encourage him/her to handle tools with proper care.

Are these toys specifically Indian?

The answer is 'yes' and 'no'. 'Yes', because these toys are indigenously made, and 'no' because many similar concepts on these toys exist in other countries too. For example, a 'wind wheel' is made and played with by children all over the world. But, the 'mango seed fan' or the 'sewing machine' is typically Indian. It is a fact that no other country apart from India has a wide range of such toys. These toys are a part and parcel of their culture. This holds good not only for toys but also for other utility items like baskets, earthen pots, textiles, etc., which are all made by hand. The other special feature is the use of recycled and discarded material which is quite common to Indian culture. The rich, diverse environment provides a wide scope for development of new concepts and ideas.

Developments ahead

These toys support the view that creativity, innovation and technical knowledge can be part of even those people who do not have any formal education or training.

Lifestyles have undergone a change, giving birth to new social themes and technologies. Used battery cells, electric wires, film rolls, reels and bobbins, tape spools, sheets and bags are discarded everyday. These can be reused to generate new ideas and new toys. Who can develop these no cost ingenious toys? And what will be the role of trained scientists, designers and educators?

After all is said and done, the most important aspect of these toys is the experience of joy and the element of creativity. These handmade toys are in reality the forerunners of would-be scientists, engineers and designers. We hope that the simple, ingenious toys documented here will help to inspire many.

This book indeed is a tribute to the genius of those 'ordinary' people who thought of and gave shape to 'extraordinary' playthings that can be prepared at no cost and with no special effort

In case any difficulty is encountered while making or playing with a toy, remember not to give up or get discouraged but, try, try again!

SECTION 1

SOUND AND MUSIC

Every moment we hear some sound. It could be the sound of our voices or those of our family and friends. Or else it could be the chirping of birds, the sound of insects, the knock-on the door, the cry of the child, the gentle patter of rain or the frightening clap of the thunder. How exhilarating it is to hear the rhythmic beats of a drum, the soft notes of the violin, the varied sounds of musical instruments all playing in harmony! The toys described in the next few pages give a glimpse of the variety of sounds produced so fascinatingly around us.

1. PAPER FLUTE

You need

A piece of paper 8 cm x 6 cm in size.

How to make it

Roll the paper as shown in the illustration. Stick the end of the paper with glue. Press the narrow end of the pipe gently. Place this end of the pipe in between your lips and blow. Your whistle is ready!

Try out

Use paper of different sizes and thicknesses and note your observations. Do not give up if the toy does not make sound. Try again.

Find out

Why is the sound produced?

What is the difference between a paper flute and a bamboo flute?

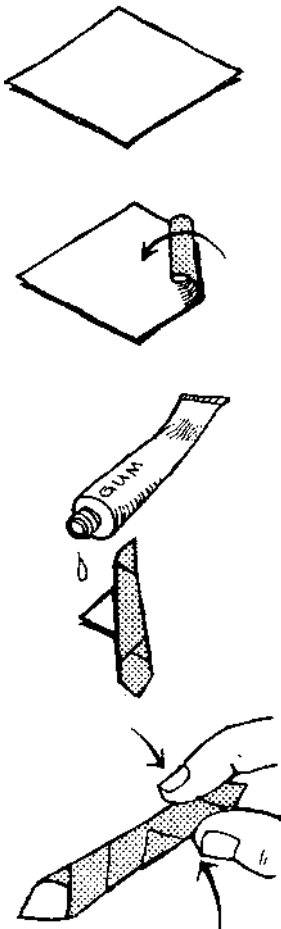

2. LEAF FLUTE

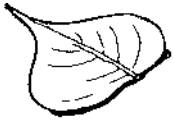

You need
A peepal leaf.



How to make it
The process is similar to that of the paper flute. The tip of the leaf should be snipped off as shown in the figure.

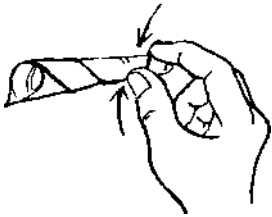

Try out
Make a short flute and a long flute.

Find out
Why is there no sound if the end is not flattened?



3. PAPER WHISTLE

You need
A paper about 12 cm x 6 cm.

How to make it
Fold the paper and make a cut as shown. Hold the paper and blow into it. You will hear a whistling sound. With practice you will be able to produce a variety of sounds by changing the intensity of blowing.

Try out
Make this toy by using thick and thin papers.

Find out
Why is sound produced?

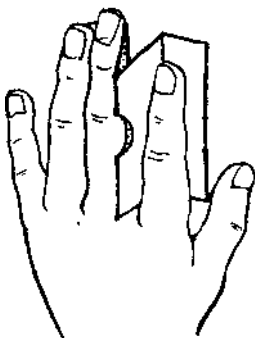
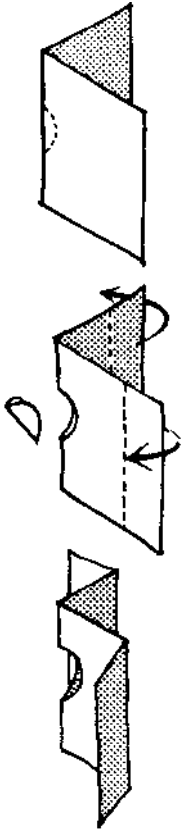

4. SIREN



You need
A rubber balloon.

How to make it
Blow air into the balloon. Hold the opening at the top with both hands as shown so that the air cannot escape. Stretch the balloon outwards and allow a little air to pass out. This will produce a fascinating sound. A little practice enables you to produce a variety of sounds.

Try out
Try using balloons of different sizes.

Find out
Is the working of this toy similar to that of the paper whistle? Why is there no sound when the opening is big and the air rushes out?



5. PUPPETEER'S WHISTLE

You need
Two thin bamboo strips
6 cm x 1 cm and a strip of balloon
5 cm x 3 mm.

How to make it
Wind a little thread on both ends of a bamboo strip. Stretch the strip of balloon over the bamboo piece and tie both the ends. Place the other bamboo strip on the first so that the stretched balloon strip is in the middle and then tie the bamboo strips together on both ends. Blow hard to hear the whistle. This is a fascinating toy used by puppeteers to provide music for their shows.

Find out
Why is there no sound if the balloon strip is tied loosely and not stretched sufficiently?

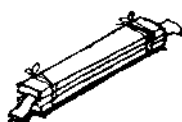
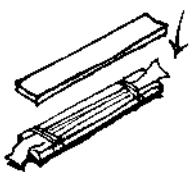
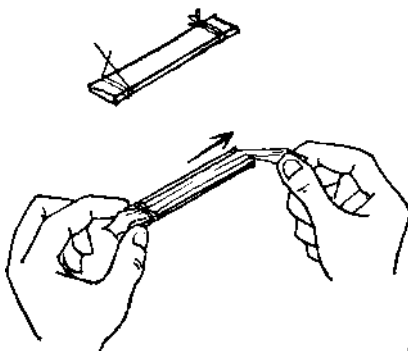
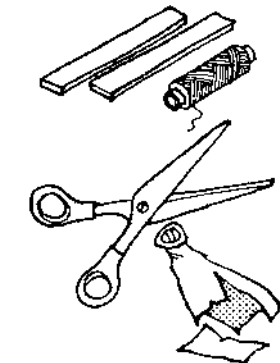



6. LEAF WHISTLE

You need

Two pieces of earthen pot, about 5 cm x 5 cm in size and a fresh leaf.

How to make it

Rub the edges of the two pieces to make them slightly rounded. Put a flat fresh leaf between these two pieces. Blow in to hear the whistle.

Try out

Can you figure out the similarities between this toy and the puppeteer's whistle. You can try using different types of leaves or pieces of paper.

Find out

Can you figure out what vibrates here?



7. TINY DRUM WHISTLE

You need

Cap of a cold drink bottle and a balloon piece.

How to make it

Stretch the balloon piece tightly over the cap. Blow air forcefully as shown. With a little practice you will be able to identify the correct angle for blowing.

Try out

Make this toy using a bigger bottle cap.

Find out

Why is there no sound if the balloon piece is not stretched tightly?

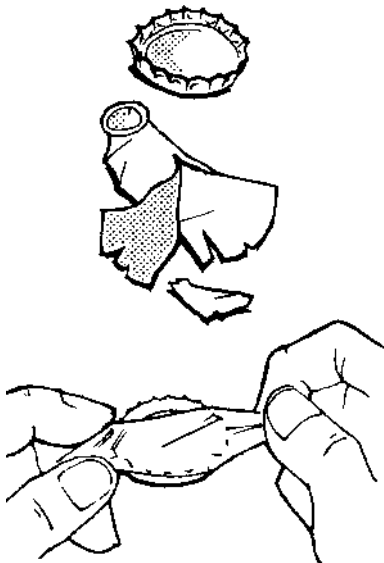

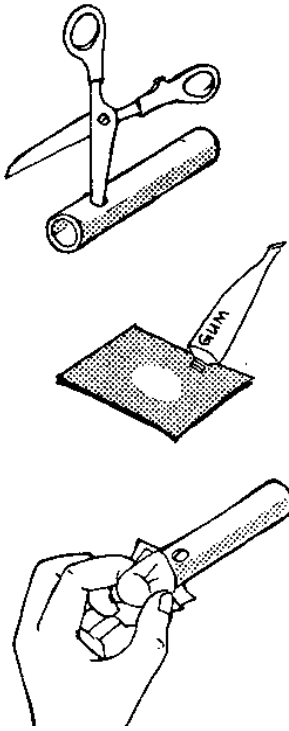
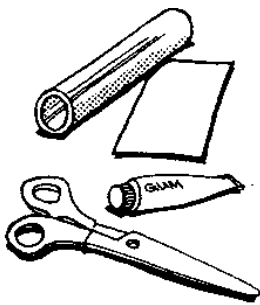

8. VOICE AMPLIFIER

You need

A card paper tube, kite paper, glue and scissors.

How to make it

Make a hole of about 1 cm diameter near one end of the tube. Stick a piece of kite paper near this end such that no creases are formed on it. The toy is ready. It works like a sound box which amplifies your voice when you bring your lips near the hole to speak.

Try out

Try using different kinds of paper.

Find out

Why does your voice get amplified?

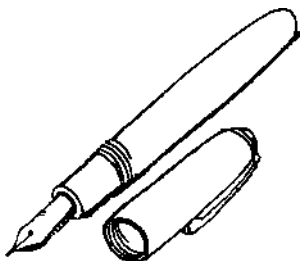

9. CAP WHISTLE

You need

A pen cap.

How to make it

This toy does not need any construction. Hold the cap of your pen and blow into it. You can hear a whistling sound.

Try out Try using various caps, bottles and Notes. Note the differences in sound.

Find out

Will, there be any sound if the cap is open at both ends?



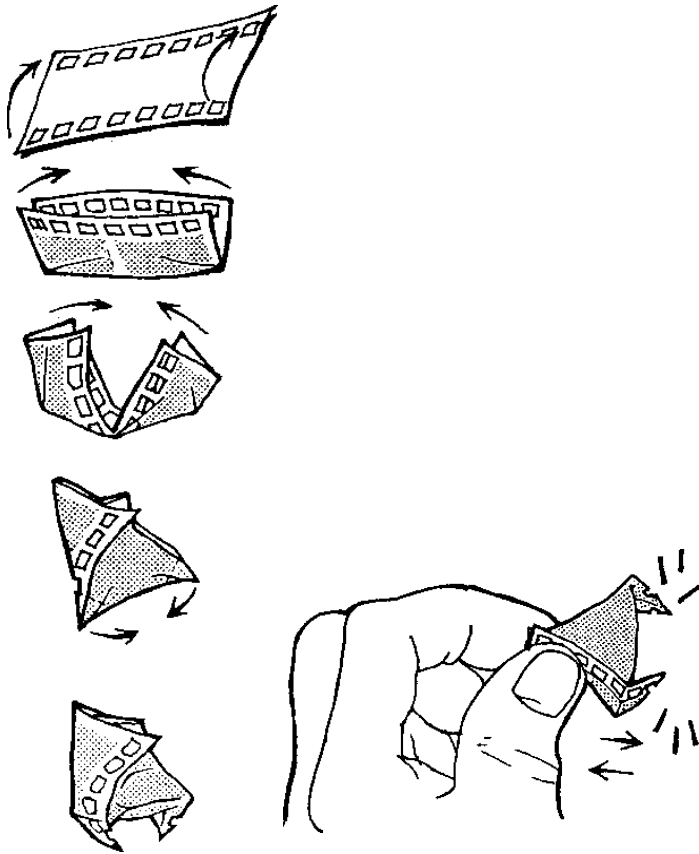

10. TIK-TIK

You need

A discarded photographic film of 6 cm length.

How to make it

Make folds and construct the form as shown in the illustrations. Strike it repeatedly on the floor to hear clicking sounds.

Find out

What makes this tik-tik sound? Can this toy if made with paper produce a similar sound?

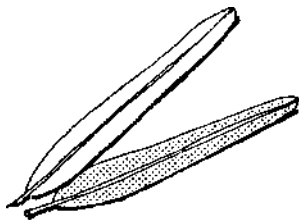

11. LEAF CLAPPER

You need

Two long and strong leaves, or two thin but stiff pieces of paper.

How to make it

Hold the two leaves in your hands and move them to and fro in quick jerks. This action produces dapping sounds.

Try out

Try with different types of leaves or with plastic or leather strips. Oleander leaves make nice clappers.

Find out

Why is there little or no sound if the leaves are struck slowly? Where does the sound come from? Is it similar to the clapping of hands? Why is there no sound if strips of cloth are used?

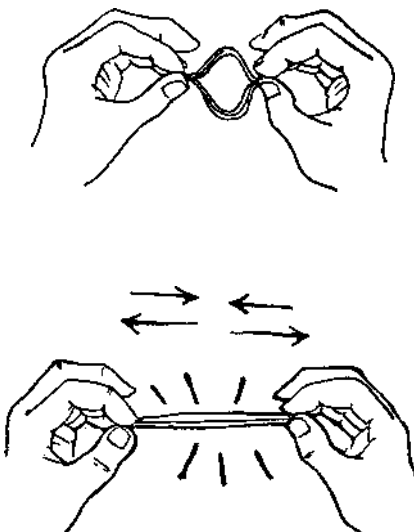

12. CIGARETTE BOX CRACKER

You need

An empty cigarette pack.

How to make it

Cut a strip all along the four sides of the pack. Roll it into a ring. Place it on your knee. With full force bring your palm down on the ring. You can hear the sound of a cracker bursting.

Try out

Cut out small and large rings from the cigarette box and observe the differences in sound.

Find out

Why is there no sound if the ring is not hit with force? Why is the sound softer when the ring is placed on the floor instead of on the knee?

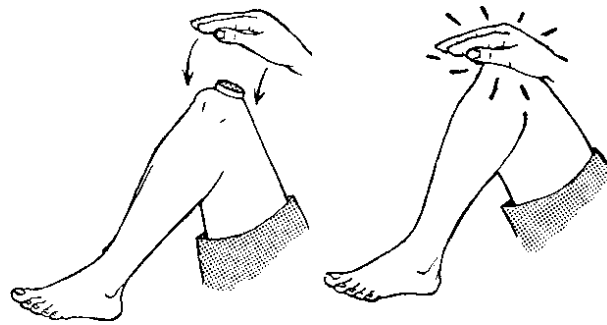
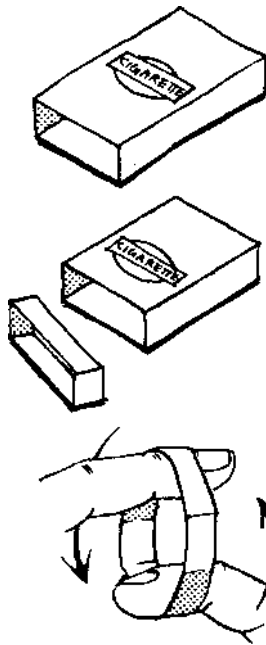

13. LEAF CRACKER

You need

A leaf.

How to make it

Place a leaf on your loosely clenched fist. Hit the leaf with full force with the other hand. You will hear the sound of a bursting balloon.

Find out

Why is there no sound when you poke your finger through the leaf instead of smashing it as shown?

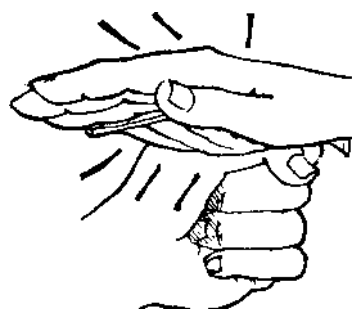
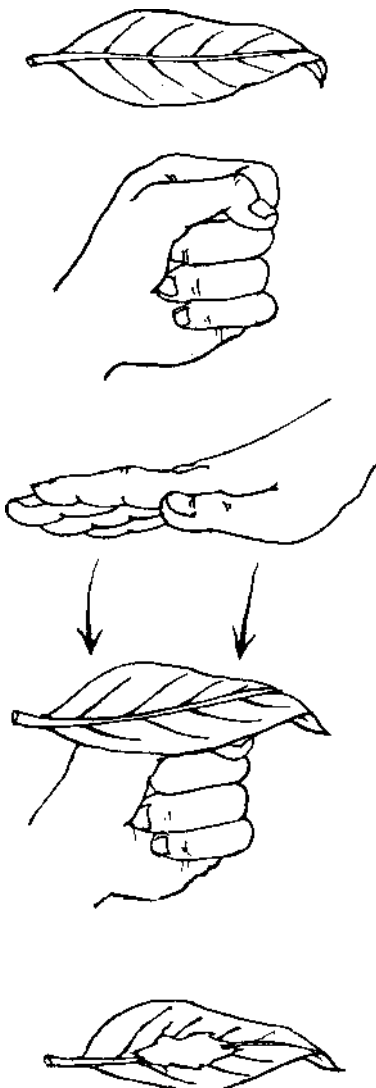

14. PAPER BAG CRACKER

You need
A paper bag.



How to make it
Blow air into the bag as shown. When the bag is completely inflated, close the mouth of the bag tightly. Smash the bag on a table. A loud bang is produced.

Try out
Try using a thin polythene bag.

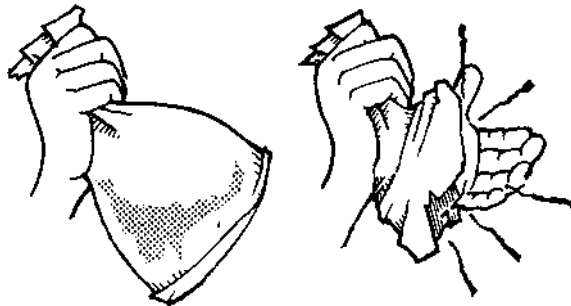

15. PAPER CLAPPER

You need
A piece of paper 20 cm x 20 cm.

How to make it
Mark lines for folding the paper at a distance of every 2.5 cm. Make a cut half way through the paper as shown. Fold both the sides. Bend the flaps on both the sides as indicated. Hold the toy as shown and quickly slide your fingers upwards to produce a clapping sound.

Try Out
You can try making the toy in different sizes, with different types of paper or with a stiff plastic sheet.

Find out
Why is there no sound when the fingers are moved upwards slowly? Why is the sound less when the thin paper is used?

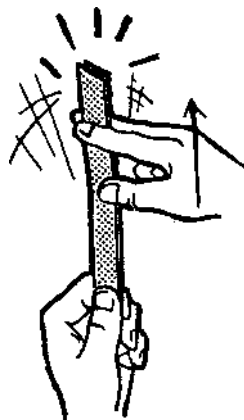
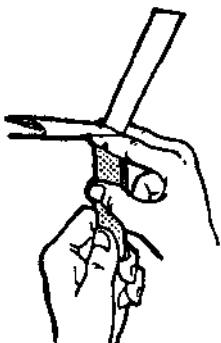
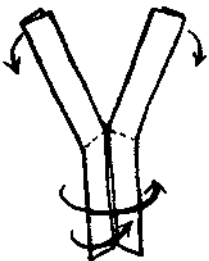
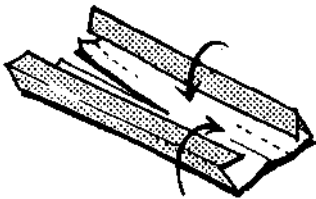
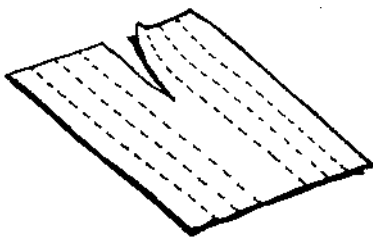

16. BANANA LEAF CLAPPER

You need

A banana leaf stem.

How to make it

Cut flaps on two sides of the stem of the banana leaf as shown. Hold the stem and shake the toy so that the flaps hit the stem alternately.

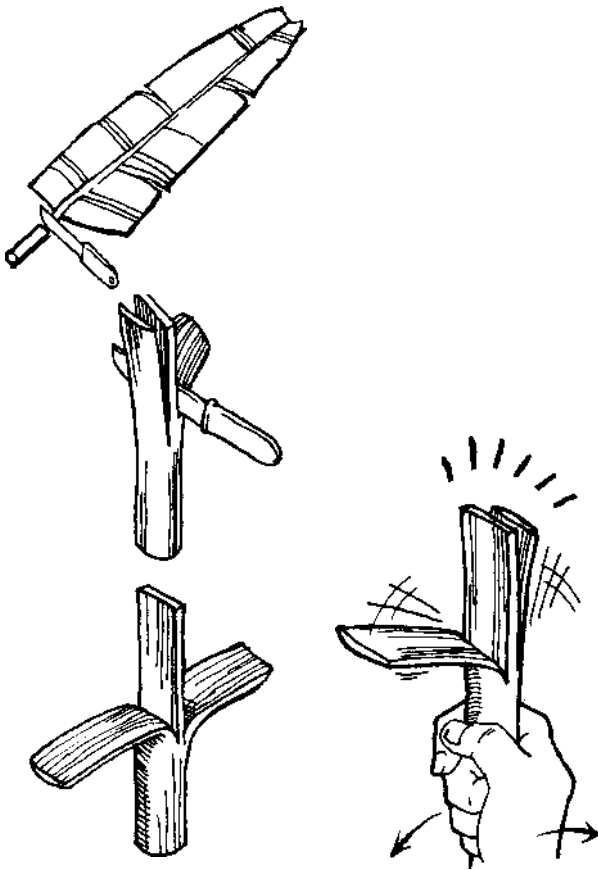

17. MATCHBOX DRUM

You need

An empty matchbox, a bamboo stick, a piece of string, a small stone.

How to make it

Make a hole on each of the two ends of the matchbox. Fix a stick vertically as shown. Tie one end of the thread around the box to fix the sticks. Tie a stone at the other end. Adjust the string length so that the stone strikes the broad surface of the matchbox. Hold the matchbox in your hand and shake to produce rhythmic sounds.

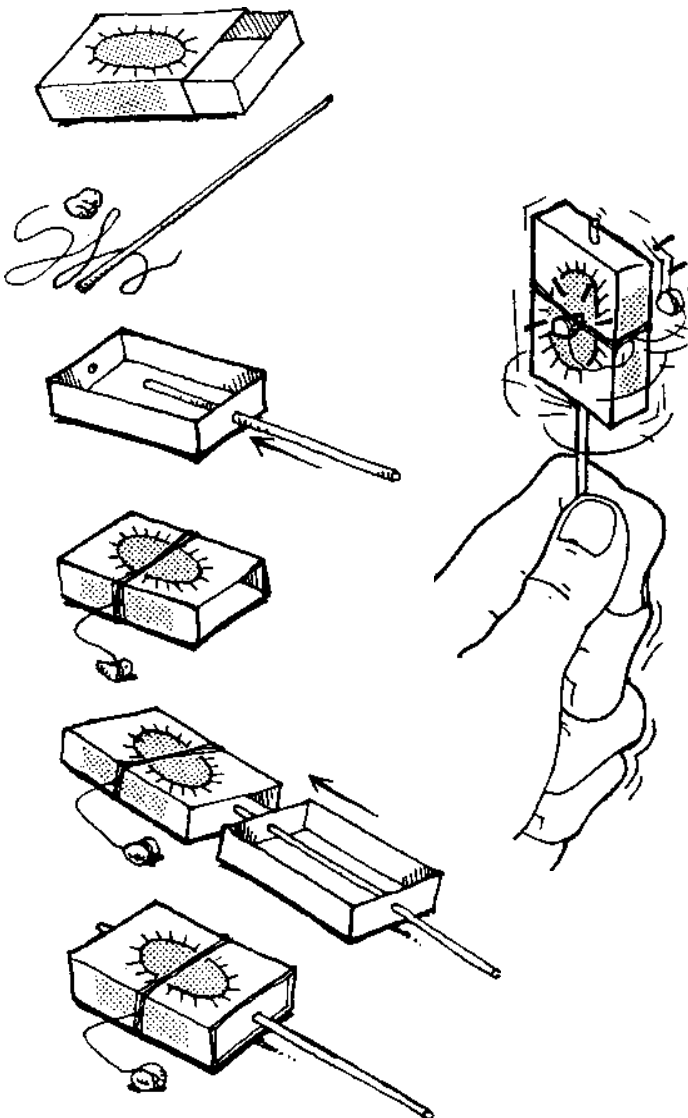

18. SEED RATTLE

You need

Seeds of *kaner* (oleander) plant and a string.

How to make it

Pass the string through the seeds and tie them together as shown. Hold the string in your fingers and strike the seeds together to produce a sound.

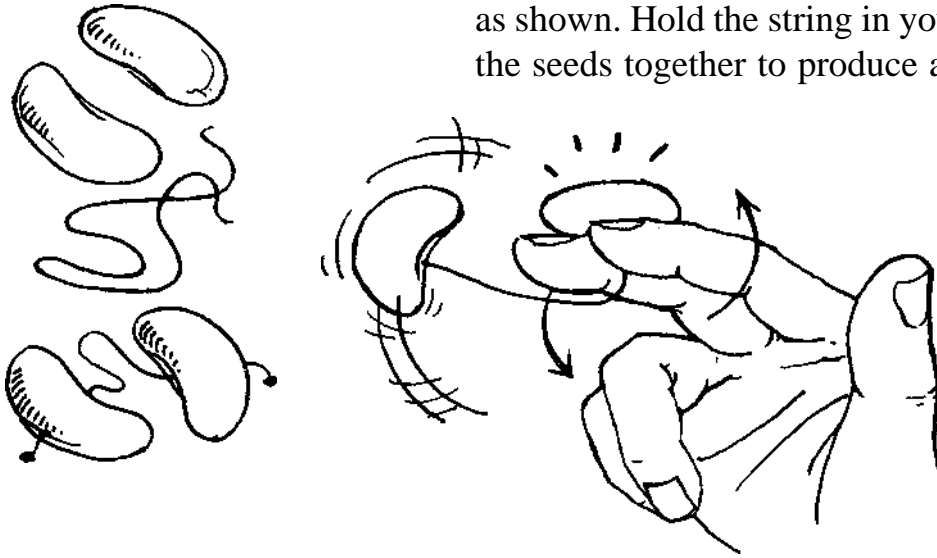

19. BALLOON RATTLE

You need

A balloon, a few grains, a bamboo stick and a piece of thread.

How to make it

Put the grains inside the balloon, fill it with air and tie it with a string to the bamboo stick. On shaking the toy a rattling sound is produced.

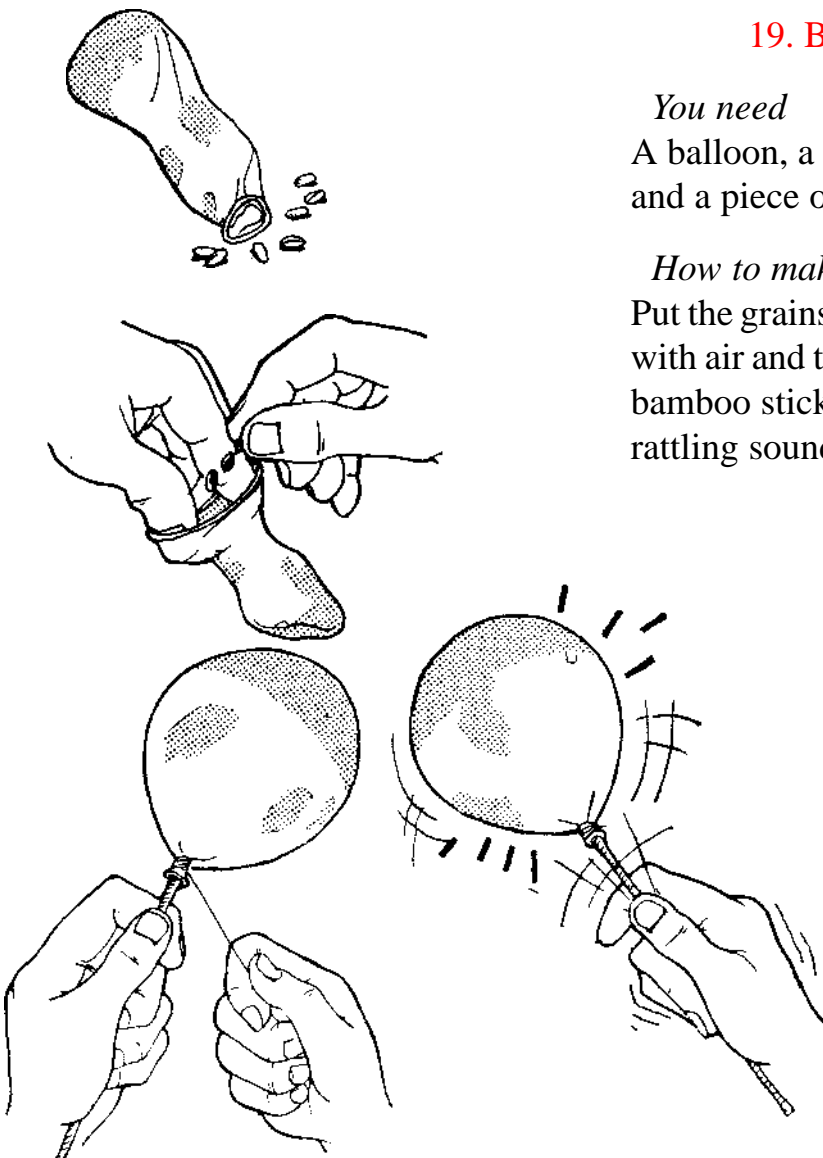

20. MATCHBOX RATTLE

You need

A thin bamboo stick, two matchboxes, a pen-knife and a few pebbles.

How to make it

Split the thin bamboo stick into two with the help of a pen-knife. Insert the two split ends into the recesses of the two matchboxes. Place a few tiny pebbles inside the matchboxes. Shake the toy and you hear a rattling sound.

Try out

Try using boxes of metal or plastic.

Find out

Why is there less sound if instead of holding the toy by the stick, you hold the matchbox? Why does the sound change when pebbles of different sizes are placed inside?

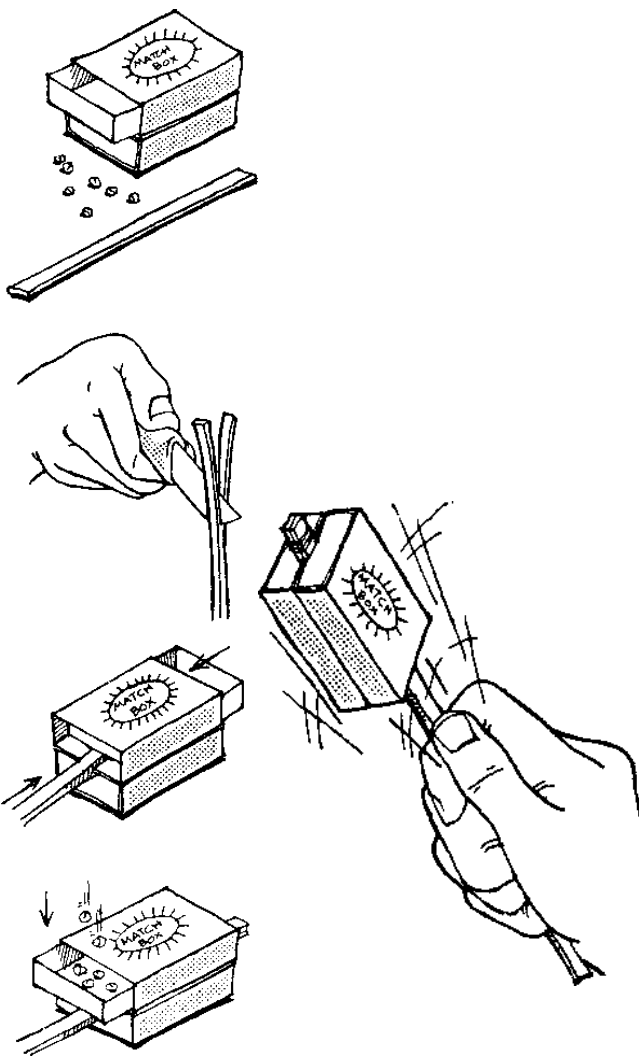

21. TICKING MATCHSTICK

You need

A matchstick, a matchbox and two rubber bands.

How to make it

Stretch the two rubber bands around the matchbox. Place a matchstick in between the rubber bands and wind it several times. On tapping one end of the matchstick, a ticking sound is produced.

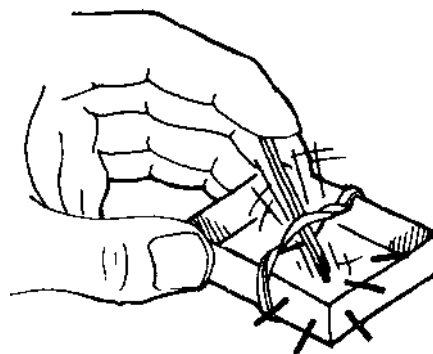
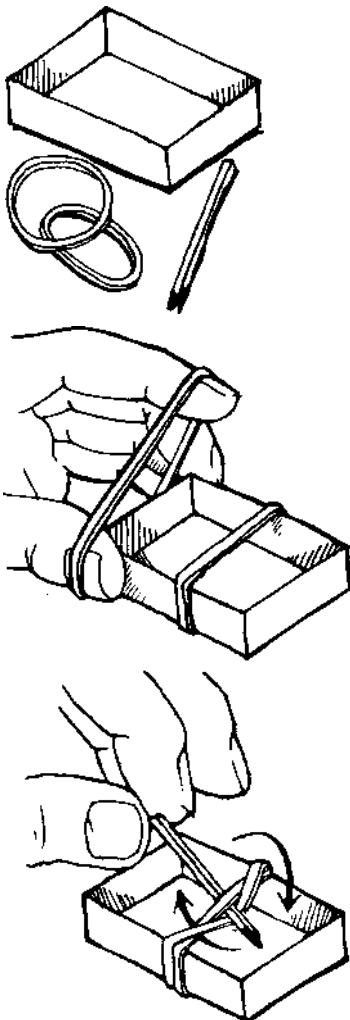

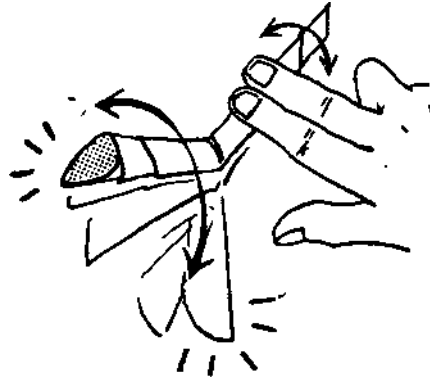
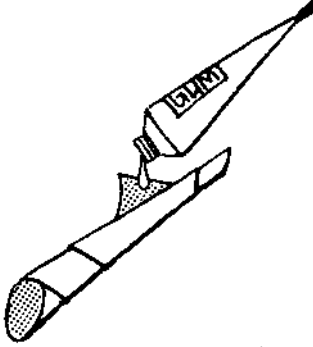
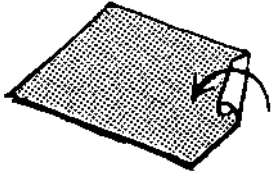
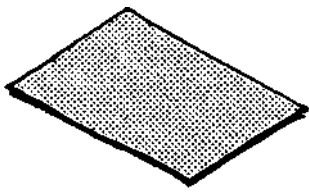

22. PAPER PIPE RATTLE

You need

Thick paper 25 cm x 20 cm (cover of any old magazine) and gum.

How to make it

Roll the paper to make a tapering pipe and stick the end of the paper with glue. Bend the pipe roughly in the middle. Roll the pipe very sharply on the floor with your two fingers. A *phut-phut* sound is produced when the end strikes the floor.

Try out

Make rattles of different lengths. Instead of paper you can use a plastic sheet.

Find out

Why is there no sound when the rolling action is slow?

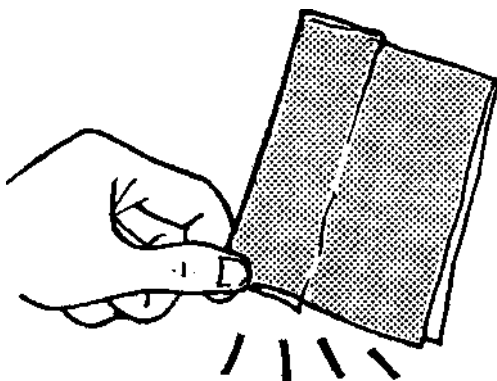
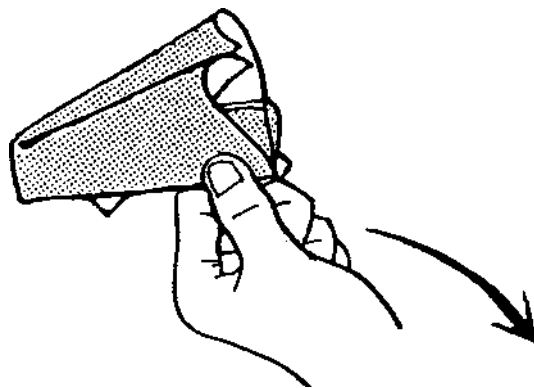
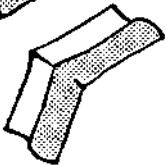
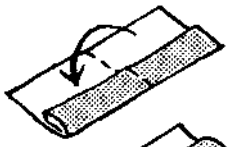
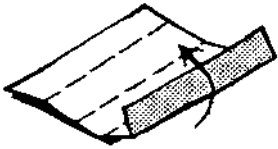
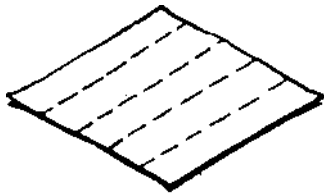

23. SOUND CRACKER

You need

A paper 20 cm x 20 cm.

How to make it

Fold the paper so as to make eight divisions. Fold one division over the other, leaving the last division as shown. Then fold the rolled paper horizontally into half. Push the thinner edges inside as shown. Hold the paper and strike it down with a jerk to produce a loud bang.

Try out

Use different types and sizes of paper.

Find out

Suppose the paper gets torn, will the toy make any sound?

Why is the sound produced?

24. TELEPHONE RING

You need

Cap of a shoe-polish box, pencil, string, hammer, knife and nail.

How to make it

Cut a groove on one side of the pencil as shown. Make a loop with the thread around the groove of the pencil. This loop should be neither too tight nor too loose. Hammer the nail through the metal cap and let the loose end of the thread pass through the hole. Tie a piece of matchstick to this end. Keeping the thread in a state of tension, rotate the pencil slowly with your thumb. A *ting-ting* sound is produced.

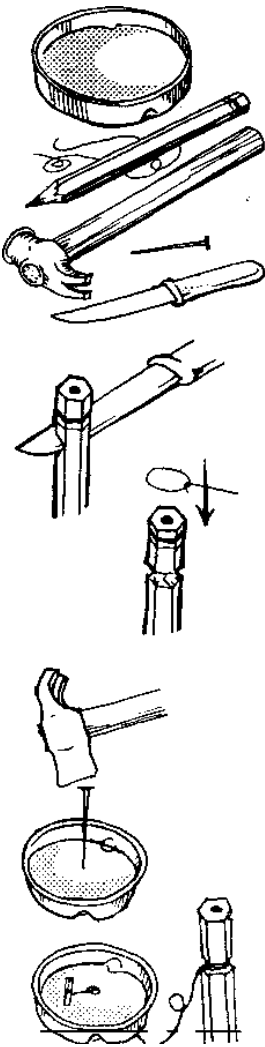

25. MATCHBOX TELEPHONE

You need

Two empty matchboxes, thread, and two matchsticks.

How to make it

Make a hole in the centre of each of the inner matchboxes. Pass the two ends of the thread through these holes and tie a matchstick at each end to ensure that the thread does not come out of the holes. Ask your friend to hold one matchbox case near his or her ear. Hold the other case near your mouth and talk. Make sure that the thread is stretched tightly. Your friend will hear your voice very clearly through the other matchbox placed on his or her ear.

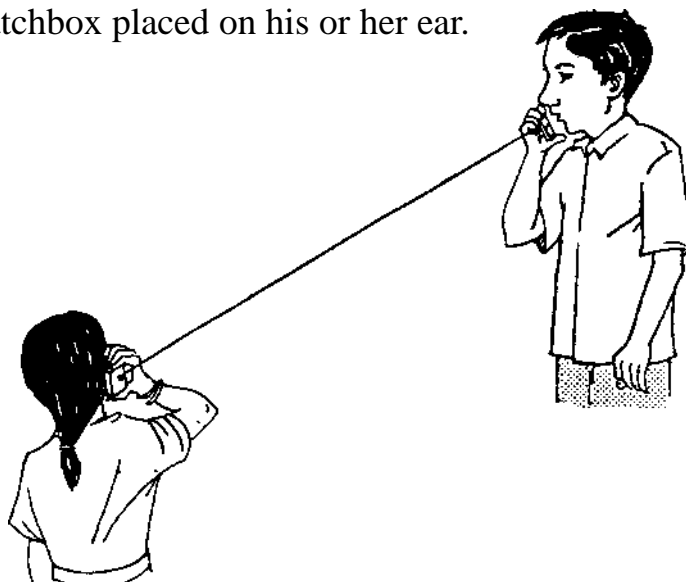
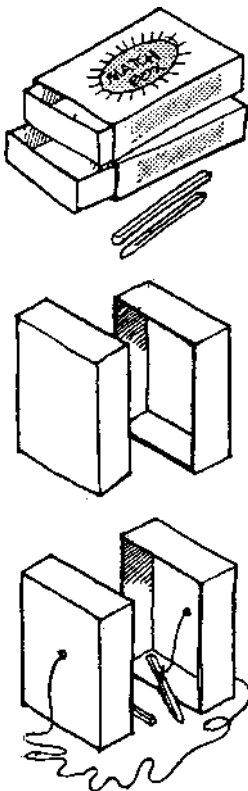

26. CAP-TAP

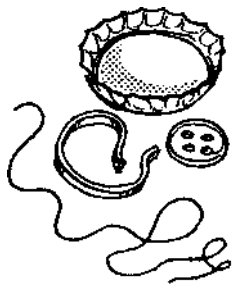

You need

Cap of a cold-drink bottle, rubber band, button, and thread.

How to make it

Cut the rubber band and pass one end through the hole in the button. Tie the two ends of the rubber band. The rubber band should neither be too tight nor too loose. Pass the rubber band over the bottle cap as shown. Take the string and pass one end through the other hole of the button and tie it up. Make knots about 5-cm apart. When you hold the bottle cap in one hand and run your fingers over the knots, the button produces a strange sound when hitting against the bottle cap.



Try out

Use different caps, like the lid of a shoe-polish tin.

Find out

Why is there little or no sound when you move your fingers slowly over the string?

In case you make the knots too far apart or too close to each other, what will happen?

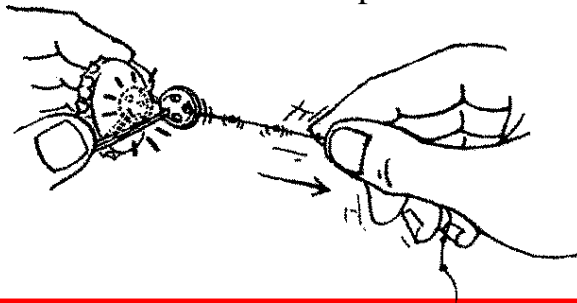

27. SPACECRAFT

You need

A piece of thin but strong paper, strong string, gum and a small stone.

How to make it

Tie the stone firmly to the string. Fix a thin paper to the string as shown. The toy is ready. Swing it round. It will make an unusual *fur-fur* sound.

Try out

Use different sizes and types of paper and note the differences in sound. Stick some coloured patterns on to the paper to obtain interesting visual effects in motion.

Find out

If a cardboard sheet is used, will you hear any sound? Why doesn't the toy work if you remove the stone?

Caution

Be sure to tie the stone firmly, otherwise it may fly off and hit someone.

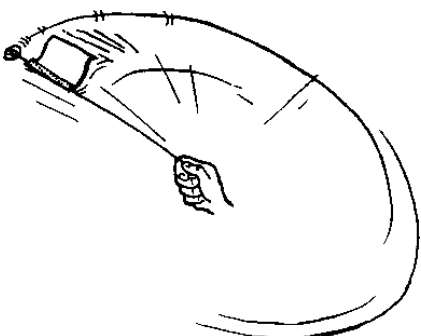
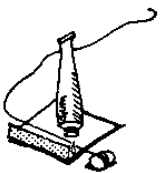

28. HUMMING BEETLE

You need

A strip of coconut leaf 30 cm long and two coconut veins of 20 cm and 50 cm.

How to make it

Cut the ends of one leaf as shown and tie them up to make a flat loop. Place the shorter vein in between the loop so that the leaf is in a state of tension. Take the longer vein and tie it as shown. The toy is ready for play. Swing it in circles. You will hear a hum like that of a beetle when the leaf flutters in motion.

Try out

Stiff paper can be used instead of a coconut leaf or else use dry broomsticks or fine bamboo sticks instead of the coconut leaf vein.

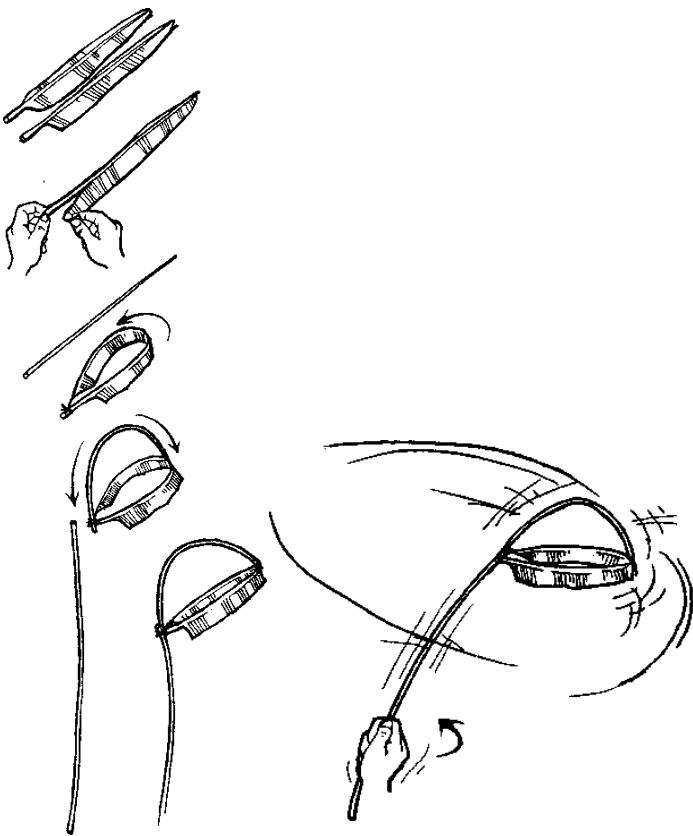

29. DIESEL ENGINE

You need

Two tubular, inflated balloons.

How to make it

All you need to do is to hold the balloons well stretched at the ends and then run. You will notice the tubular balloons fluttering and making a rhythmic sound, similar to that of a small diesel engine.

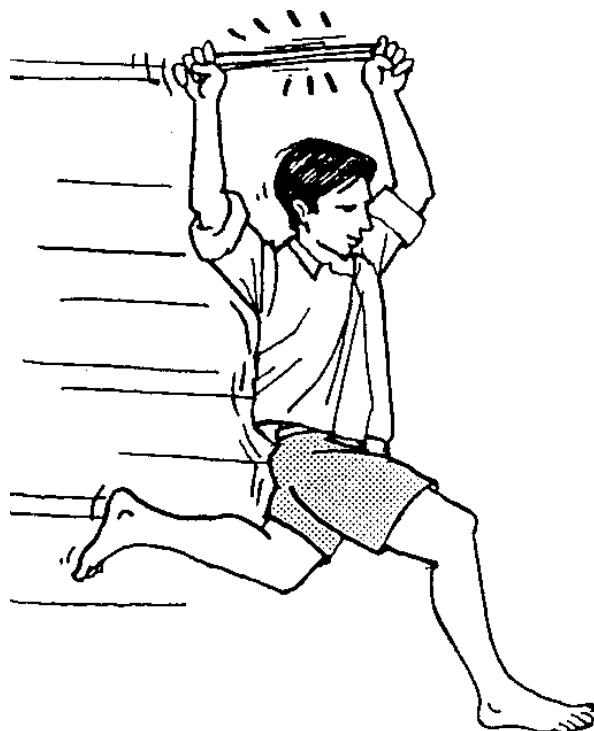
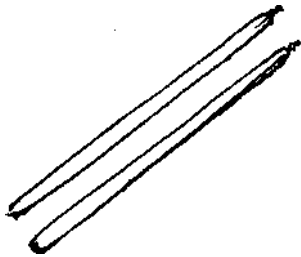

SECTION 2

TIMELESS DEVICES

'Science, technology and design' came into existence with the creation of tools first made in stone and wood. Our Stone Age ancestors began by making a hammer, a knife and a spear. The ability to make fire brought a revolutionary change in man's life-style and culture. The tip of a stick made to rotate fast on another piece of wood became the basis for inventing a drill. In the Agriculture Age that followed the Stone Age, many new tools and devices came to be developed. This became the starting phase of the development of modern science and technology. For instance, the bow and arrow is one of the oldest devices to store and use mechanical energy. Archers in the distant past knew by instinct the role of wind, the pull of gravity on the arrow in motion and the speed of moving targets—a sprinting animal. Mechanics, as also the science of rocketry to some extent, owe their existence to the basic knowledge acquired when using the simple bow and arrow.

The toys described in the following pages are based on the earliest tools and devices used by our ancestors.

30. BOW AND ARROW

You need

A bamboo strip approximately 50 cm long, 10 mm wide and 3 mm thick, and a piece of strong string.

How to make it

Smoothen the edges of the bamboo strip as shown. Tie the string to the two ends of the bamboo so that it curves. Now make an arrow by cutting a bamboo strip about 30 cm long. Round off the edges. Place the arrow on the string, pull towards yourself and release it. The arrow shoots off.

Caution

The arrow should not be aimed at any living being.

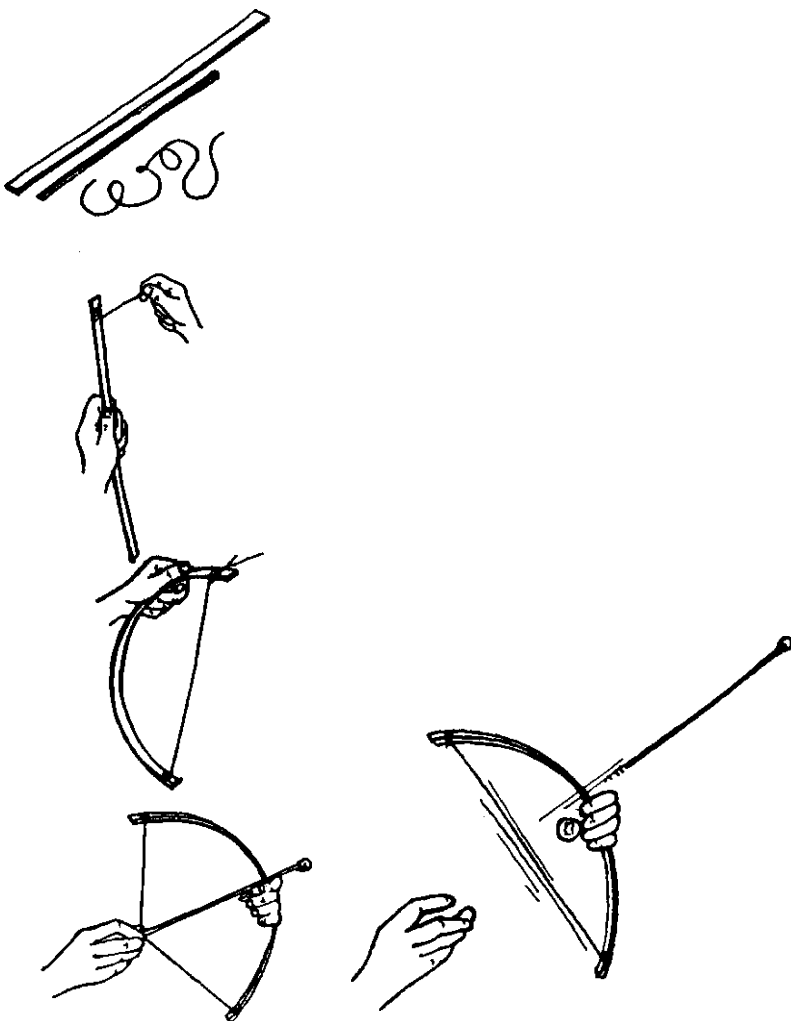

31. BULLET SHOOTER

You need

A strip of bamboo about 30 cm long and 5 mm thick, and a pebble.

How to make it

Hold the pebble on one end of the stick. Pull the stick backwards and release it.

Caution

Never aim the pebble on living beings.

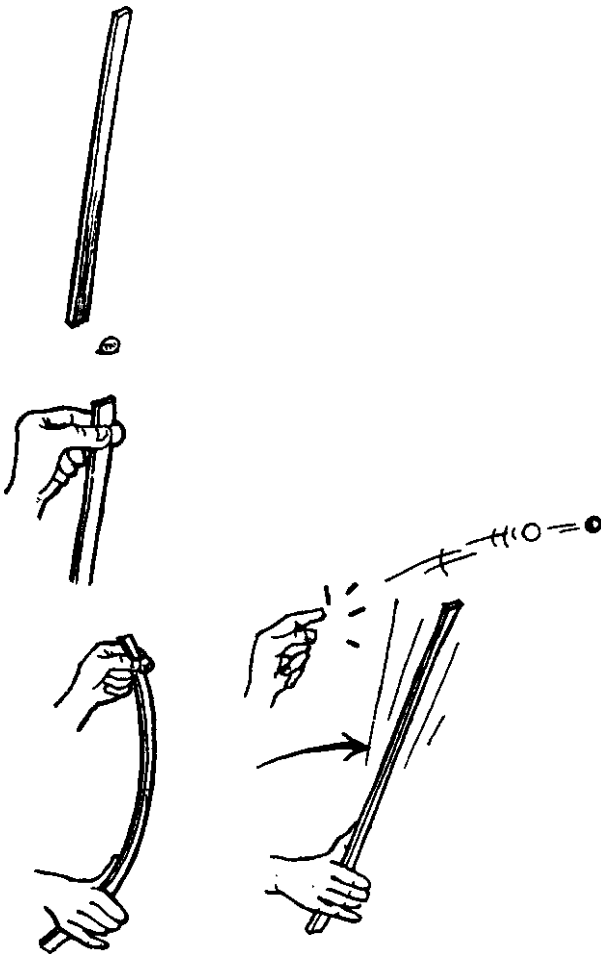

32. CATAPULT

You need

A 'Y'-shaped twig of a tree, strips of discarded cycle tubes and a string.

How to make it

Cut a cycle tube (10-cm x 3-cm) so as to make a centre piece. Punch slits as shown; Cut two rubber strips of 20 cm x 2 cm out of the cycle tubes. Fix these to the twig and at the base as shown. Hold a small stone in the rubber base. Pull the strips back and release to propel the stone.

You can aim the stone at a target of your choice. Place an old tin at a distance for target practice.

Caution

Do not aim the stone at a living being.

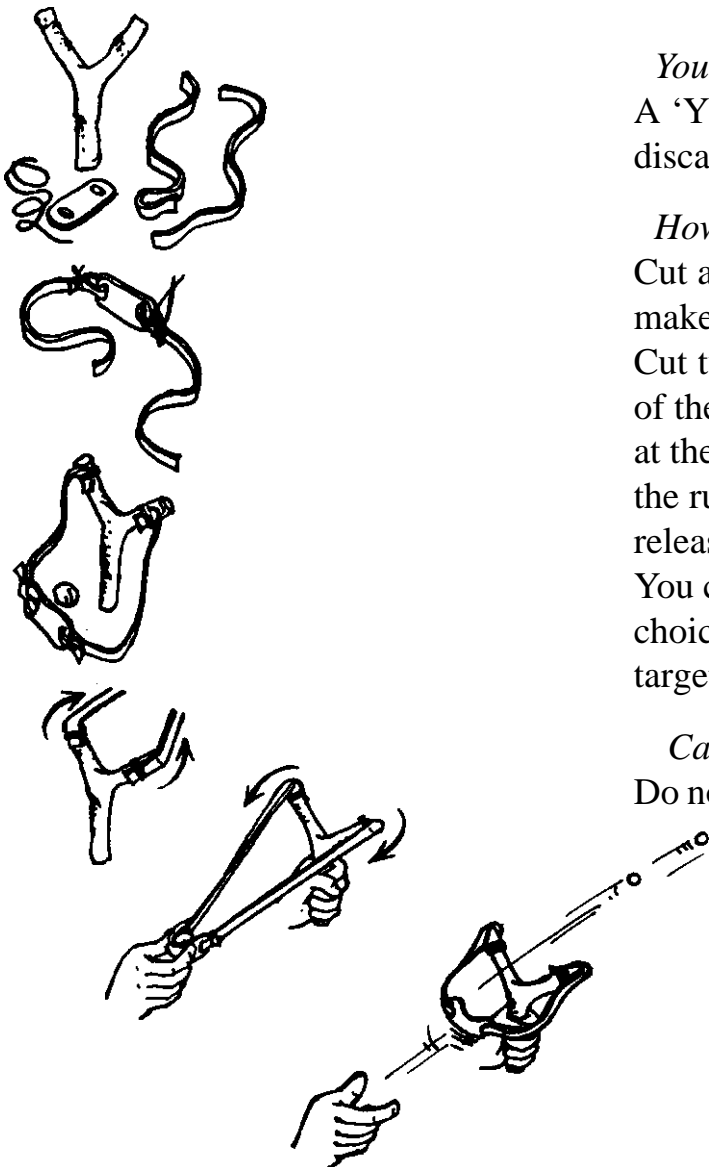

33. PAPER BULLET

You need

A rubber band and a piece of paper.

How to make it

Hold a rubber band in the two fingers as shown. The piece of paper is rolled and folded into a 'V' and held over the stretched rubber band. It shoots off when you release it.

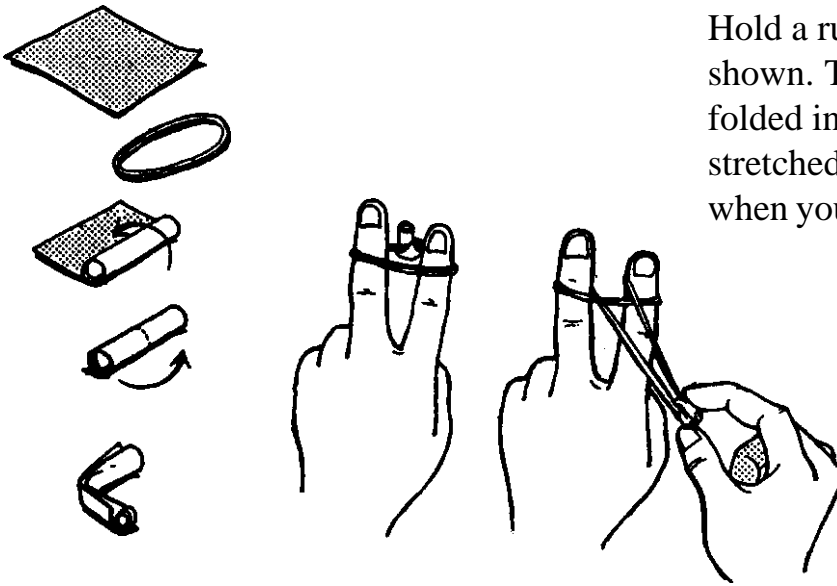

34. TINY ARROW

You need

An empty thread reel or a hollow reed, a rubber band, a string and a stick.

How to make it

Tie the rubber band with a piece of string to the thread reel. Pull the stick over the rubber band and release. It will shoot off.

Caution

Do not aim the stone at a living being.

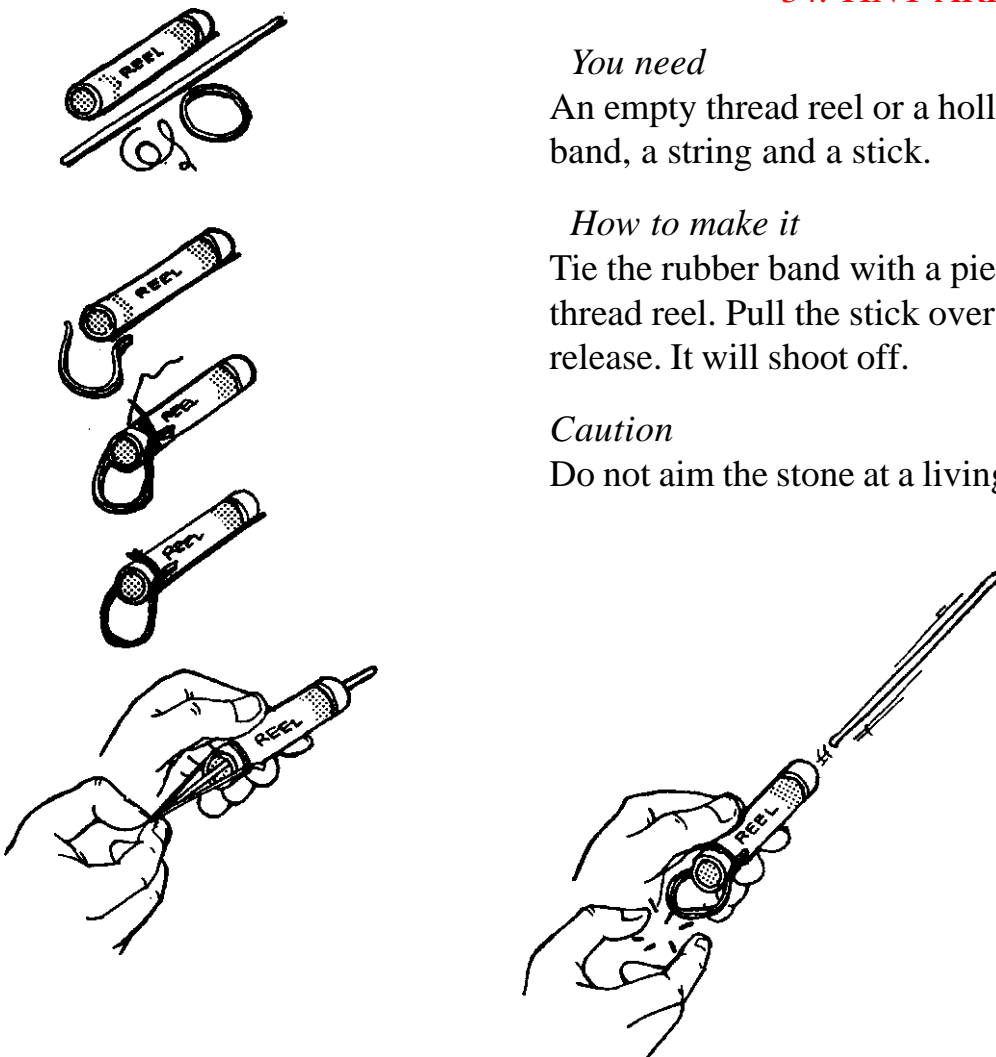

35. MATCHBOX PISTOL

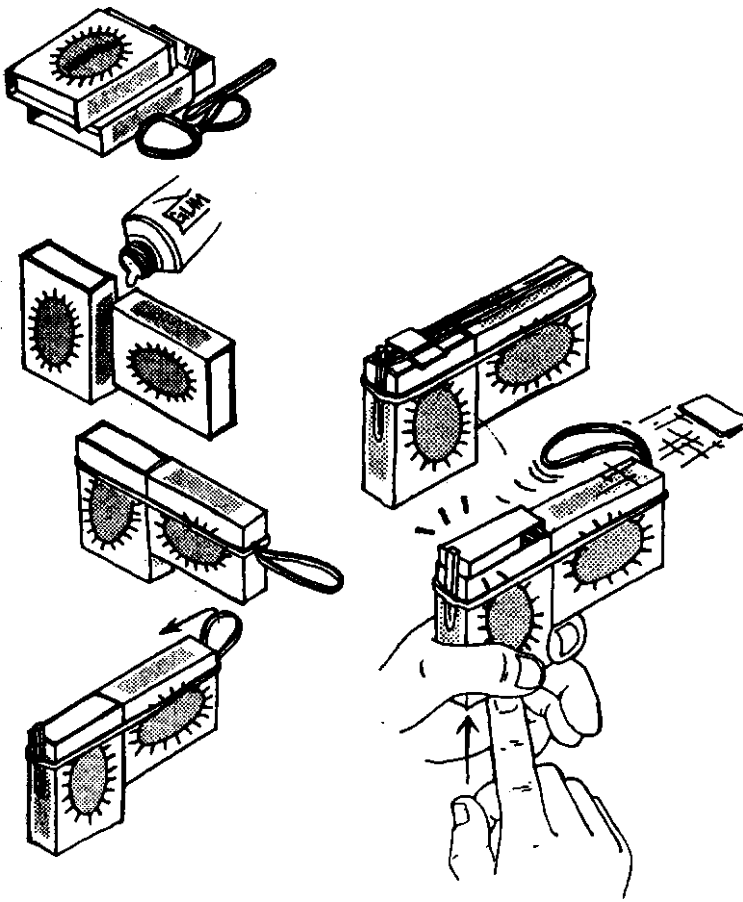

You need

Two empty matchboxes, two rubber bands, a used matchstick, a piece of cardboard and glue.

How to make it

Fix two matchboxes with the rubber band as shown. Pull the free rubber band backwards over the matchboxes and fix the loose end on the tip of the matchstick. Place a tiny rolled piece of card paper near matchstick. Hold the toy with one hand and push up the case of the matchbox. With the other hand. On releasing the rubber band the bullet flies off.

36. CLIP PISTOL

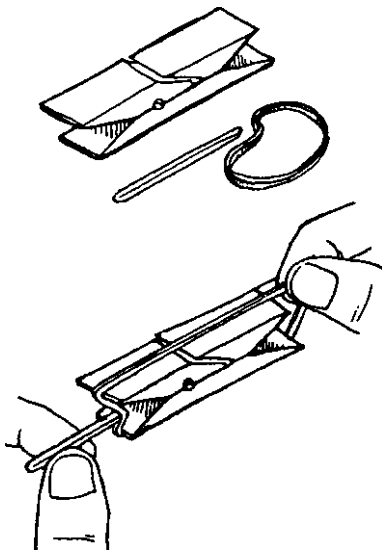

You need

A wooden clothesline clip, a matchstick and a rubber band.

How to make it

Place the rubber band and the matchstick as shown. When you press the ends of the clip, the matchstick shoots off. The toy works better with a wooden clip than with a plastic one.

Try out

Use sticks of different thicknesses.

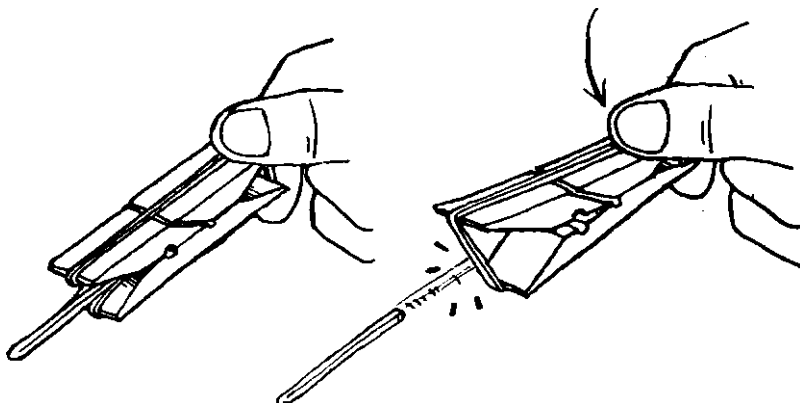

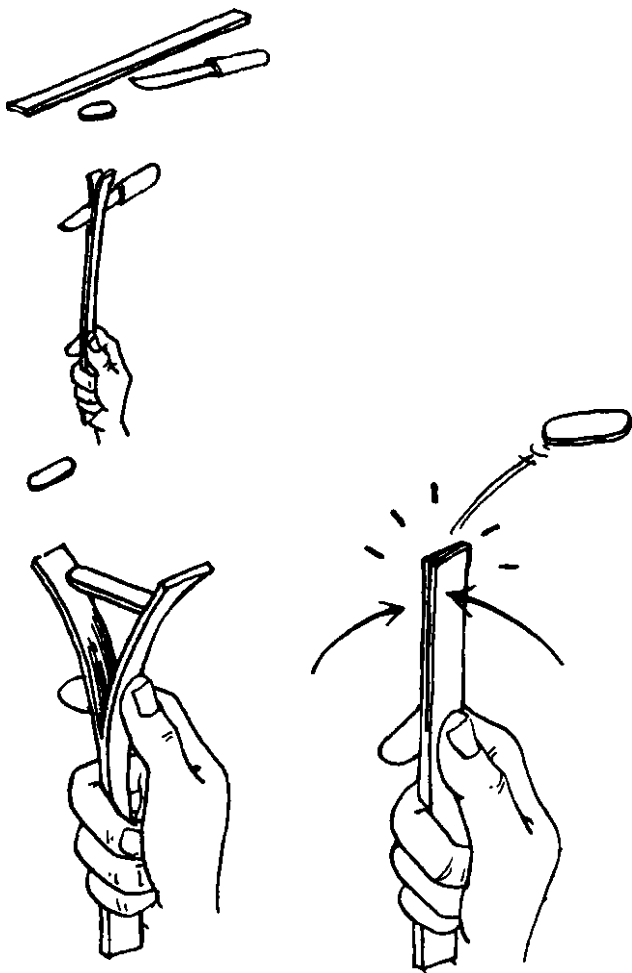

37. FLYING BULLET

You need

A bamboo stick 20 cm long, 10 mm wide and 5 mm thick.

How to make it

Make a vertical slit in the middle of the stick and running up till half its length. Make a bamboo bullet 3 cm long and 1 cm wide, or use a piece of earthen pot. Place the bullet between the slit ends of the bamboo. Hold and press the two ends as shown. The 'bullet' flies off.



38. SLING

You need

A piece of leather or canvas 8 cm x 5 cm and two strong pieces of string, about 50 cm each.

How to make it

Cut an oval piece of leather and make holes at the two ends as shown. Tie the two pieces of strings at each of the two holes. Make a knot at each of the loose ends. Place the stone in the leather piece. Hold the strings firmly and swing them around before releasing one of them suddenly. The stone flies off.

Note

The sling is especially popular in villages and is used by farmers to drive away birds from the fields. You may need to learn from someone who knows how to play with the sling. It needs skill to swing the sling without dropping the stone and releasing one of the strings at the right moment.

39. SHOT PUT

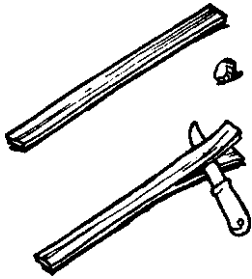

You need
A bamboo stick 30 cm long, 10 mm wide and 5 mm thick.

How to make it
Make a long slit on the stick with a pen-knife. Hold a stone in the slit. Make a throw as shown.

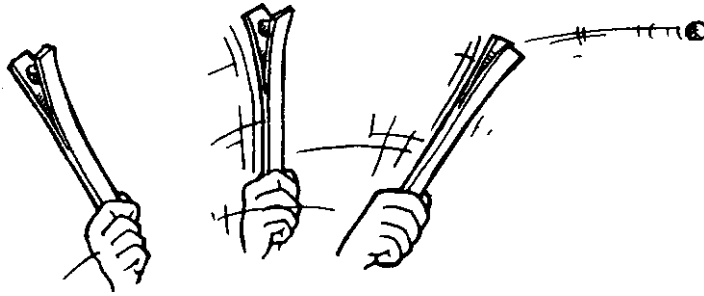

40. SPINNING DISC

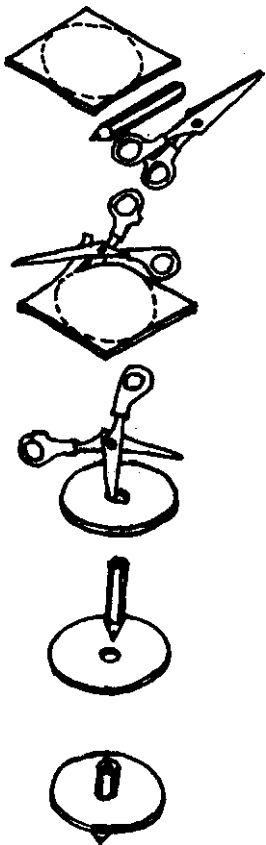

You need
A thick cardboard 8 cm x 8 cm, a small used pencil about 5 cm long and a pair of scissors.

How to make it
Cut a circular disc about 8 cm in diameter on the cardboard. Make a hole of the same diameter as the pencil pieced in its centre. Fix the pencil tightly into this hole. Spin the pencil like a top.

Try out
Make discs of different sizes and shapes and note which spins longer. Try making this toy with a bottle cap or even a rubber cap.

Find out
Will the toy rotate if the pencil is not fixed in the centre?
Why does the toy rotate better if you use bigger and heavier discs?
Why does the disc move better if it is kept closer to the ground?

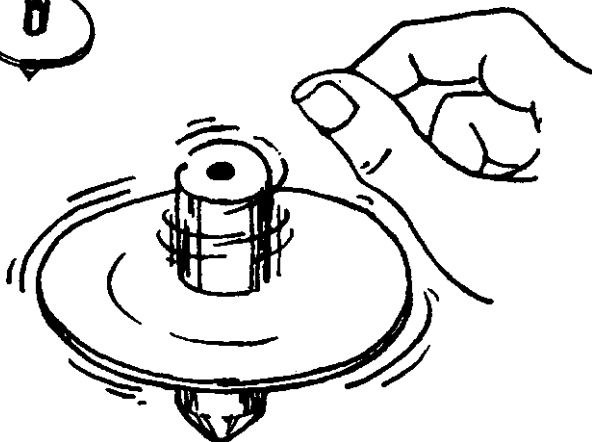

41. SPINNING WHEEL

You need

A flattened bottle cap or cardboard disc, thread, and a piece of strong string.

How to make it

Pierce two holes in the disc or cap. Pass the string through the two holes and tie the ends into a knot. To play with this toy you wind the thread by holding the two ends of the thread in your hand and giving it a few twists. Quickly pull the thread by moving your hands apart and then bringing them closer to release the tension. Continue this back and forth motion.

Try out

Try using different sizes of buttons, caps or discs. Divide the discs into three parts and paint them yellow, red and blue respectively.

Find out

If you make holes off the centre, will the toy rotate? Why do larger and heavier discs rotate better?

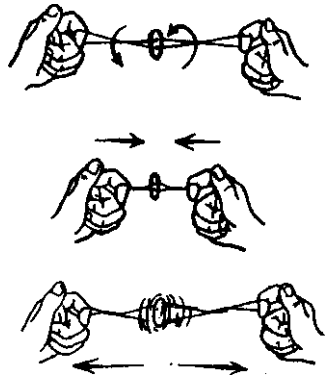
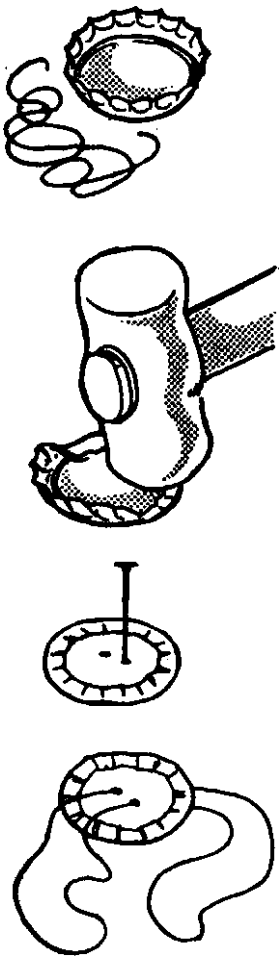

42. SPINDLE

You need

Two strings, each 80 cm long and a wooden or bamboo stick 6 cm long.

How to make it

Tie the two strings at their ends. Make 'V' cuts on both ends of the stick to hold the thread as shown. Hold the two ends of the string on two toes of your feet. Now turn the stick so as to wind the thread a number of times. Then, holding the stick place the other loop as shown. Make the stick unwind a little so that it transfers a few windings to the other loop as well. The ends of the second loop should remain free. Now hold the two ends of the second loop and pull them gently. The stick rotates. The pulling and releasing action results in continuous motion.

Find out

What is a traditional lathe machine used for? Does it work on a similar principle as this toy?

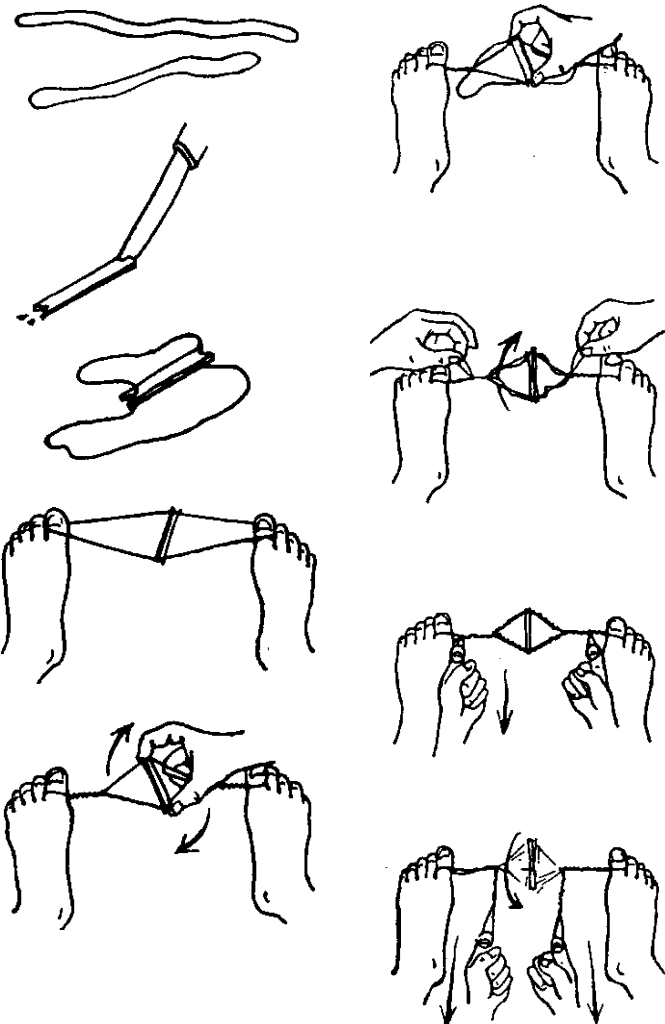

43. FAN MACHINE

You need

Three bamboo pieces, one hollow, round piece closed at one end and about 10 cm long and 2 cm in diameter, one stick 15 cm long and 5 mm in diameter, another 10 cm long, 2 cm wide and 5 mm thick and a piece of string.

How to make it

Make a hole at a point about one-third along the length of the hollow, round piece of bamboo. Tie the two sticks into a cross as shown. Tie a string to the long stick at a point corresponding to the position of the hole. Draw the free end of the string out of the hole with the help of a wire. Turn the horizontal stick so that the thread winds around the vertical stick inside the bamboo. Pull the string with a jerk and release it. Continue this action to make the stick rotate.

Try out

Use a pen cap instead of bamboo.

Find out

Do you know that the wooden butter-milk churner works on this principle? Why doesn't the toy move continuously when the thread is pulled slowly?

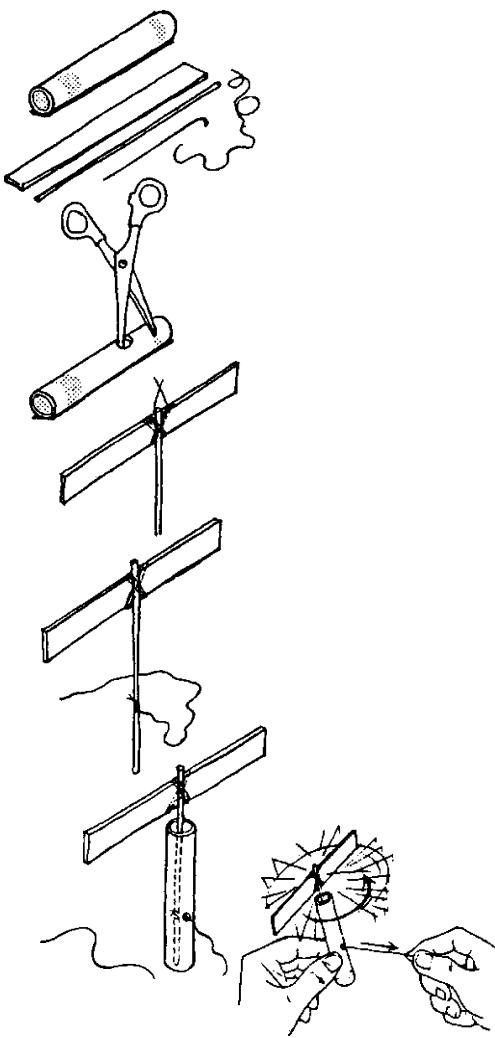

44. MANGO-SEED FAN MACHINE

You need

Two mango seeds, a pointed bamboo stick, a piece of thread, a pen-knife and a piece of wire.

How to make it

Hollow out one of the mango seeds by cutting one end and scooping out the pulp with the help of a knife. Make a hole in the centre of the seed. Now, take the other seed and force the pointed stick through its hard shell. Tie the thread to the stick as shown. Now place this stick along with the thread in the hollowed-out shell. Draw the thread out from the hole with the help of a wire hook. Then play with this toy, first of all wind the thread by rotating the second seed. Now pull the thread with a jerk. You will notice the spinning action.

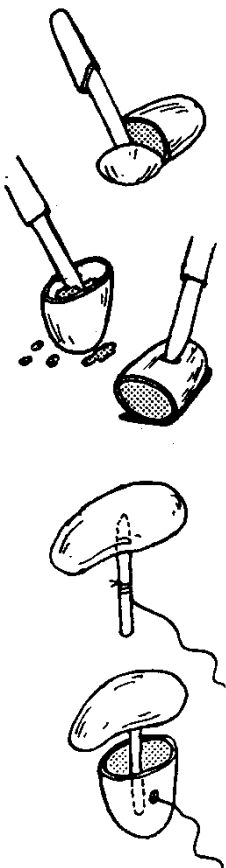

45. ANT AND THE FAN MACHINE

You need

A rubber plant seed, two small pieces of palm leaf, a pointed bamboo stick and a piece of string.

How to make it

Fix two pieces of the palm leaf on to the stick as shown. Pierce two small holes for the stick and the string. Hollow out the rubber plant seed by placing it near an ant hill (the ants eat the pulp inside the seed in a day or two). Tie the end of the string to the stick and place the stick inside the hollowed-out shell.

Draw out the loose end of the string.

Now turn the blades of the palm leaf to wind the string on the stick. Pull the string in jerks. With practice you can learn to keep the fan in continuous motion.

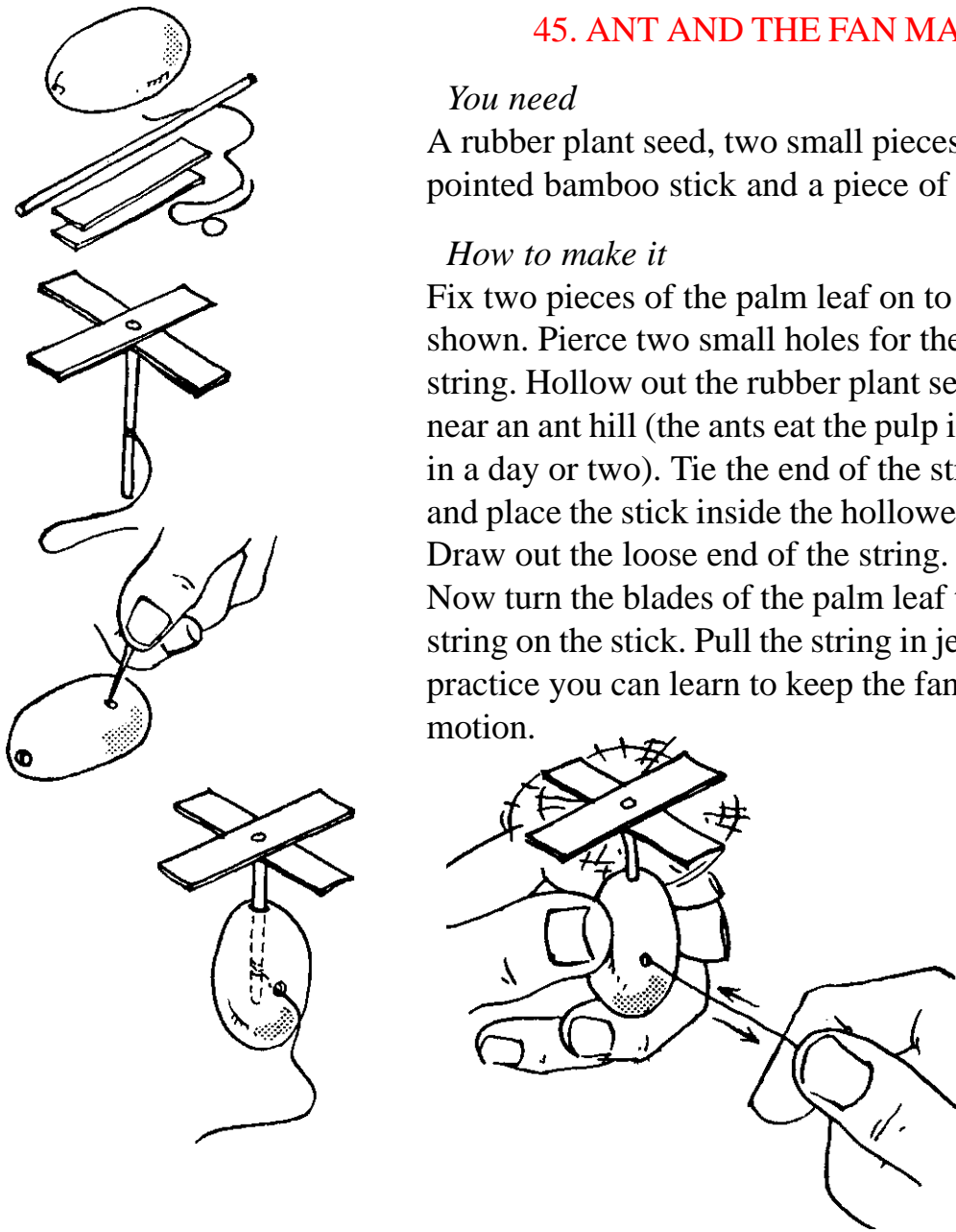

SECTION 3

SPELLS OF MOTION

A toy pager fan could well have provided the inspiration for the present-day electric fans used in our homes. inversely, the dramatic invention of the aeroplane must have inspired the design of the paper planes used as toys. A simple paper kite has much in common with the aeroplane as far as its ability to fly is concerned. The simple wheel and cart toy has a direct link with the transport devices developed over the years.

What is illustrated in the next few pages is how these simple toys are the seedlings of science, technology and design, and how simple innovative toys can provide both fun and action.

46. PAPER FAN

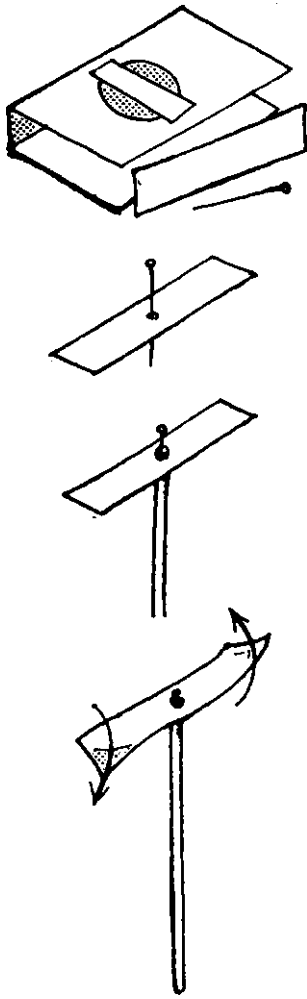

You need
A paper strip 10 cm x 2 cm, a pin and a stick.

How to make it
Cut a paper strip from an empty cigarette pack. Fix the strip on the stick with the help of a pin. Give a little twist to the ends of the blade. Hold the toy against the wind or run while holding it in your hand.

Try out
Make paper fans of different sizes and note which gives better results.

Find out
Why do the blades need a little twist?
Why does the fan rotate?

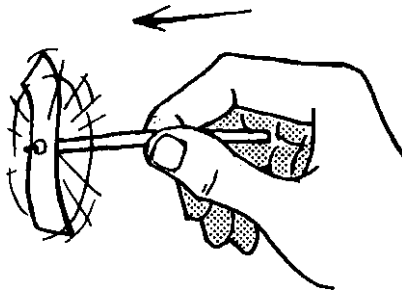

47. LEAF FAN

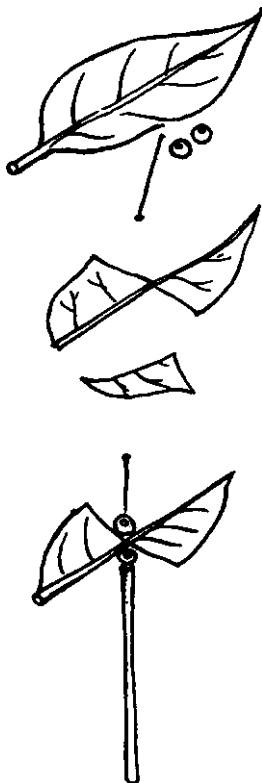

You need
A leaf, a stick and a pin.

How to make it
Fix the leaf to the stick with the pin as shown. Follow the same procedure as that employed in the paper fan to make your leaf fan.

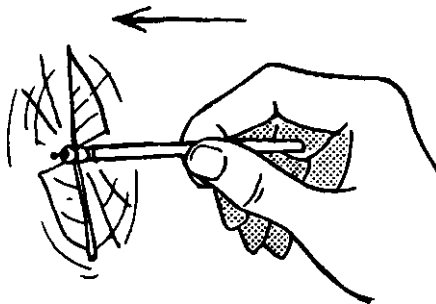

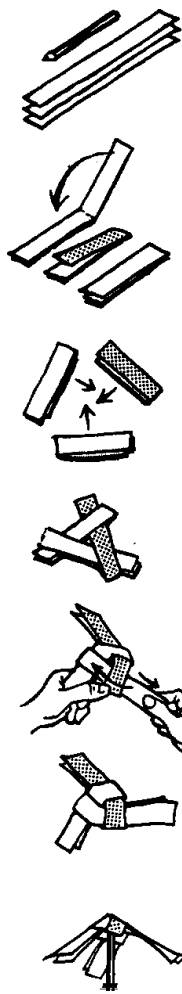

48. WIND WHEEL

You need

Three strips of thick paper 20 cm x 2 cm each and a blunt-edged pencil.

How to make it

Take the three strips and fold them into half. Interlock them as shown. Place the blunt-edged pencil in the centre of this fan and nm to make the wheel rotate.

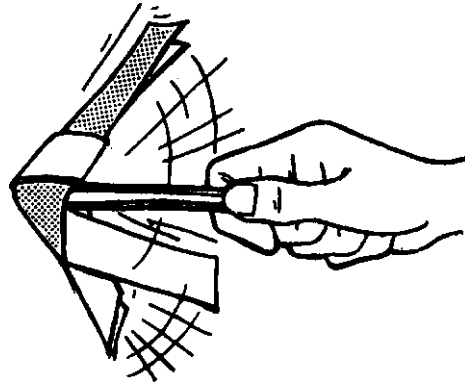

49. WINDMILL

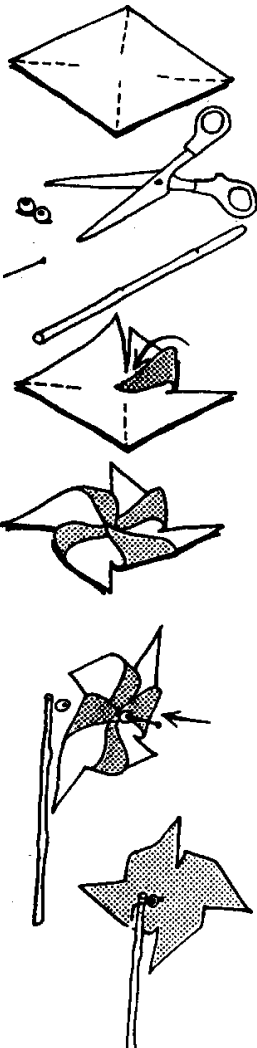

You need

A thin, stiff piece of paper 15 cm x 15 cm, a pin, two beads and a reed.

How to make it

Mark the lines and make the cuts as shown. Place the blade ends at the centre but do not press the folded portion. Pass a bead through the pin and fix the four blades together as shown. Insert another bead through the pin to fix the blades to the stick. Hold the toy against the wind to make it rotate.

Try out

Make this toy with different types and sizes of paper.

Find out

Will the wheel rotate if one blade is shorter?

Why does the wheel rotate only when placed against the wind direction?

Why does it move when you run with it?

Do you know of any appliance or machine based on this principle?

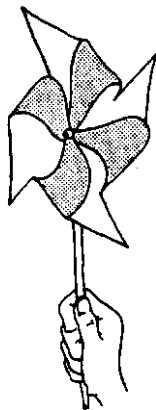

50. SMALL KITE

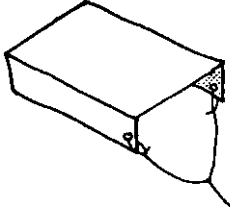
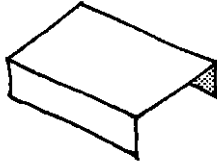
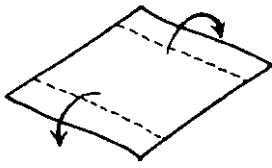
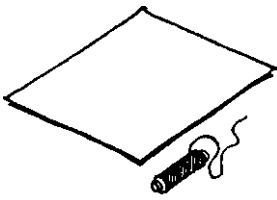

You need

A piece of paper 20 cm x 15 cm and a piece of thread.

How to make it

Fold the paper as shown. Tie the thread to it and your kite is ready.

If the wind is strong the kite will fly well, but if the wind current is weak, you will have to run with the kite to make it fly.

Try out

Make kites of different sizes and note the way they fly.

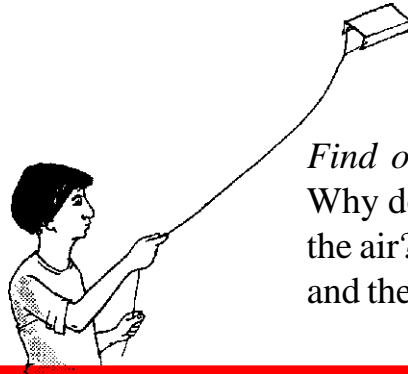

Find out

Why do the kites rise and neat in the air? What is similar to this kite and the aeroplane when flying?

51. PROFESSIONAL KITE

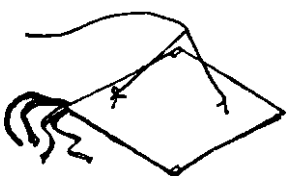
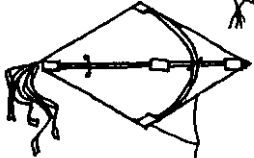
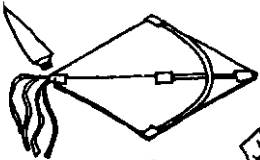
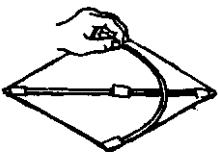
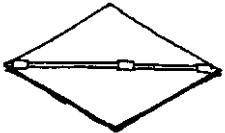
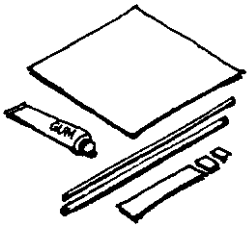

You need

A kite paper 30 cm x 30 cm, two long bamboo sticks (one 3 mm thick and the other 2 mm), glue, knife, thread and strips of kite paper.

How to make it

Take the kite paper and attach the thicker bamboo stick along its diagonal. Fix the thinner stick to the thicker one with the help of glued pieces of paper. Bend the two ends of the stick and fix these on the paper. Secure it in place with small strips of glued paper. Strips of paper can be attached to the tail end of the kite. Two ends of a thread are tied at points as shown and then to a long string.

This kite turns out better if made under the guidance of an expert.

Try out

Make kites of small and large sizes and change the angle of the string to suit the air currents.

Find out

Why can't the kite fly if it is torn? Why is the smaller kite difficult to fly? Fly a kite with a tiny weight fixed to it. Collect kites of other countries.

52. WHIRLING FAN

You need

A strip of thin paper 12 cm x 3 cm and a pair of scissors.

How to make it

Cut the strip vertically into two along less than half its length. Make two small cuts horizontally. Fold the two lower portions inside to overlap each other. Bend the upper portions horizontally.

Drop the toy from a height and watch it rotate as it descends. If it does not rotate properly, change the length of the blade.

Note

Have you ever watched the large blades of a helicopter rotating at high speed? These blades push the air down with great force, causing the machine to rise up. In the whirling fan the opposite action takes place. Air causes the blades to rotate.

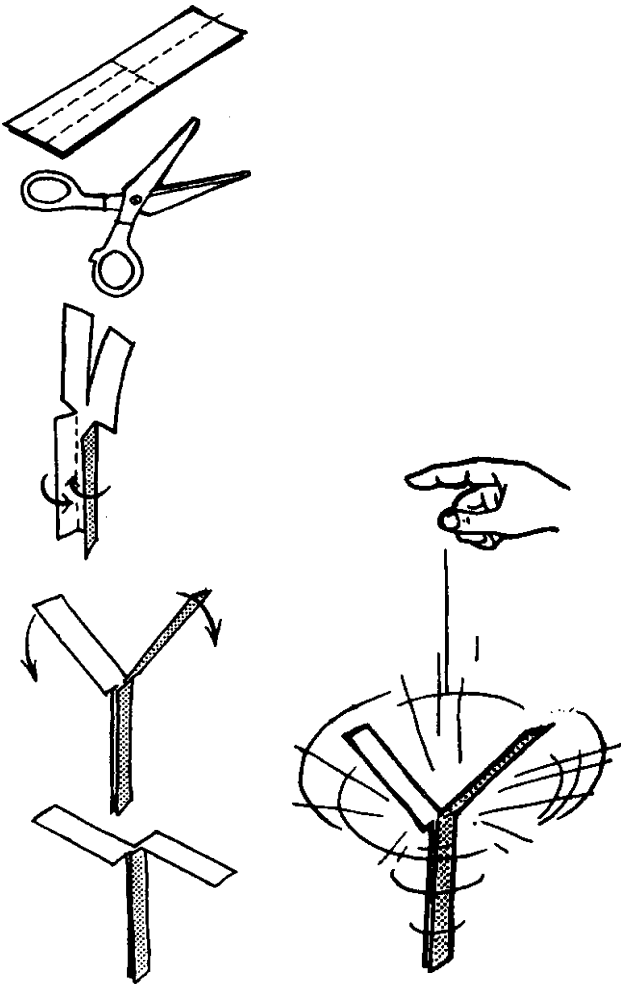

53. WHIRLING CUP

You need

A piece of paper 15 cm x 15 cm, glue and a pair of scissors.

How to make it

Roll the paper into a cone as shown. Glue the open end to the side of the cone. Snip off the protruding triangular top of the cone to get a circular top. Make cuts 2 cm apart till one-third length of the cone towards the centre. Then spread out these flaps to look like an open flower. Drop this toy from a height. It will descend slowly with a whirling motion.

Try out

Give a slight twist to the blades of the fan similar to that seen in ceiling fans. This will make the fan rotate well. Try making fans of different sizes.

Find out

Suppose the blade on one side is longer, will the toy work? If a little weight is added to one of the blades which are of the same size, will the fan rotate?

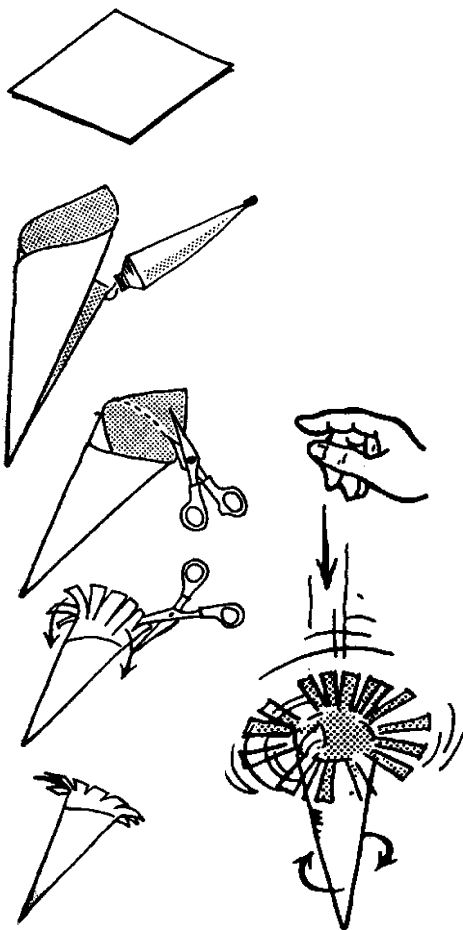

54. HELICOPTER

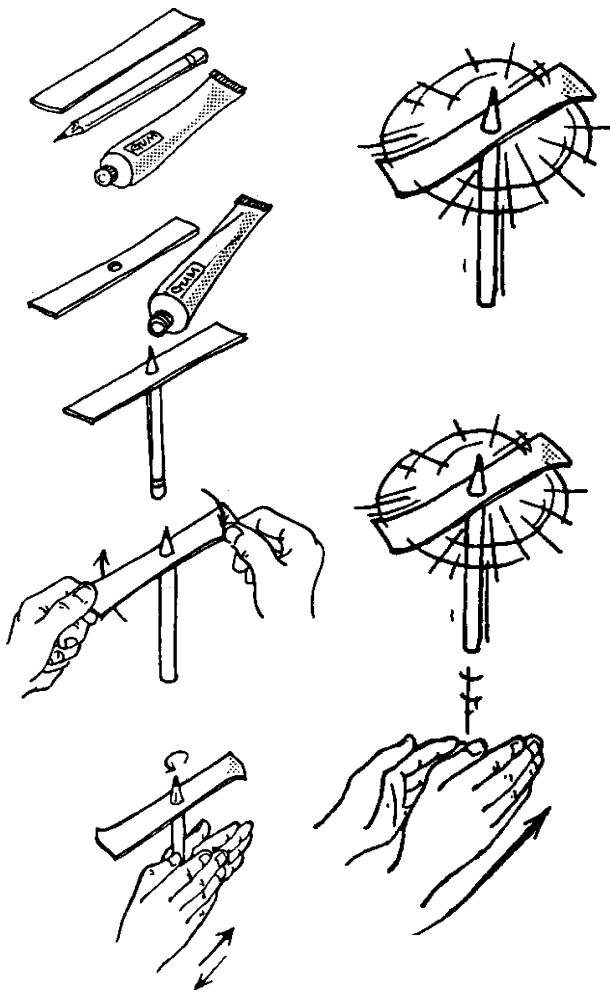

You need

A cardboard strip 20 cm x 3 cm, a pencil or a bamboo stick and glue.

How to make it

Make a hole in the centre of the cardboard strip. Fix the cardboard strip to the pencil with glue. Give a little twist to the blades. Hold the pencil between your palms and spin it. Throw up the toy quickly into the air. The toy spins and floats in the air.

Try out

Make toys of different sizes and note the changes in their performance.

Find out

Why is the twist to the blade necessary? If you fix the stick off the centre to the blade, will the toy work?

55. FLOATING PAPERS

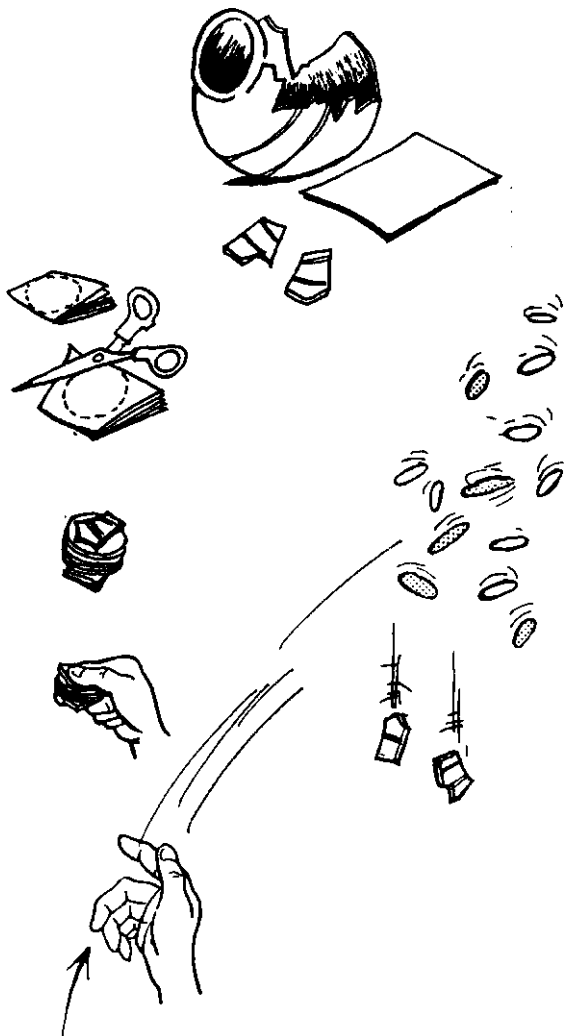

You need

Two pieces of broken earthen pot 5 cm x 5 cm and 20 circular pieces of kite paper, each about 5 cm in diameter.

How to make it

Put the pieces of paper between the two pieces of earthen pot. Throw the total package upwards. You will find the pieces of earthen pot come down abruptly to the ground while the pieces of paper float around before descending slowly.

Find out

Why do the papers float?

56. PARACHUTE

You need

A handkerchief, four pieces of thread and a stone.

How to make it

Tie the threads of equal length, to the four comers of the handkerchief. Tie the stone to the four ends of the threads as shown. Ensure that the threads are of the same length. Drop the parachute from the terrace of your house and watch it descend slowly downwards.

Try out

Instead of using a handkerchief try using a plastic sheet.

Find out

Will this toy work where there is no air, like, for instance, on the moon?

If there is a hole in the handkerchief, will the toy still work?

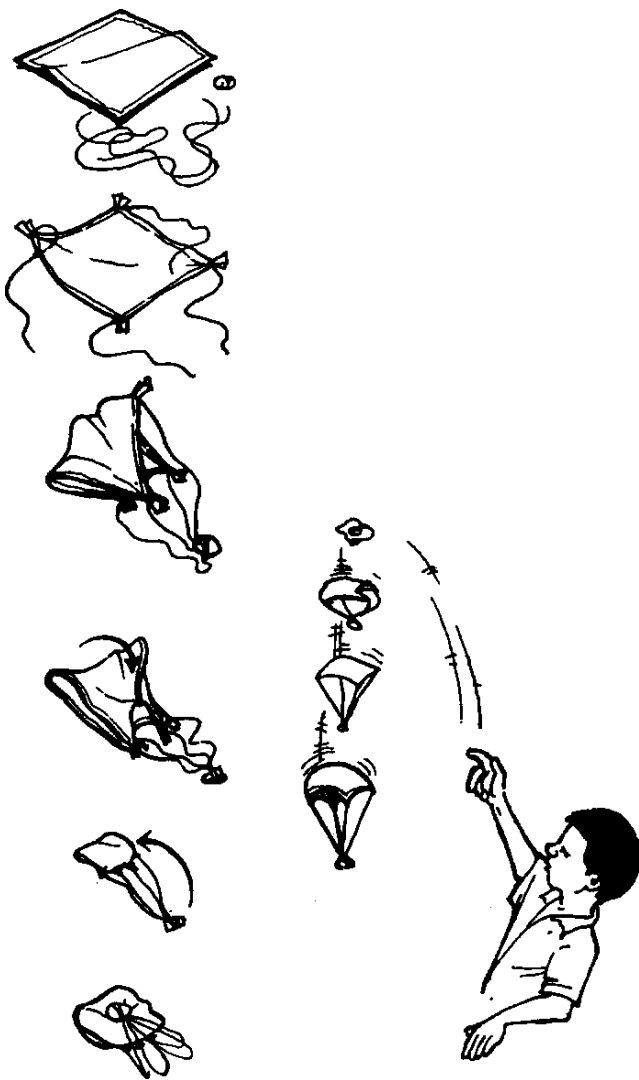

57. JET PLANE

You need

A piece of paper 15 cm x 20 cm.

How to make it

Fold the top comers of the paper along the dotted lines so that the comers meet. Give another fold along the base as shown. Fold the comer towards the top of the dotted lines. Make further folds as shown. Your plane is ready to take off. To get a better gliding action give a little curve to the wing ends. Throw the plane into the air and watch it glide.

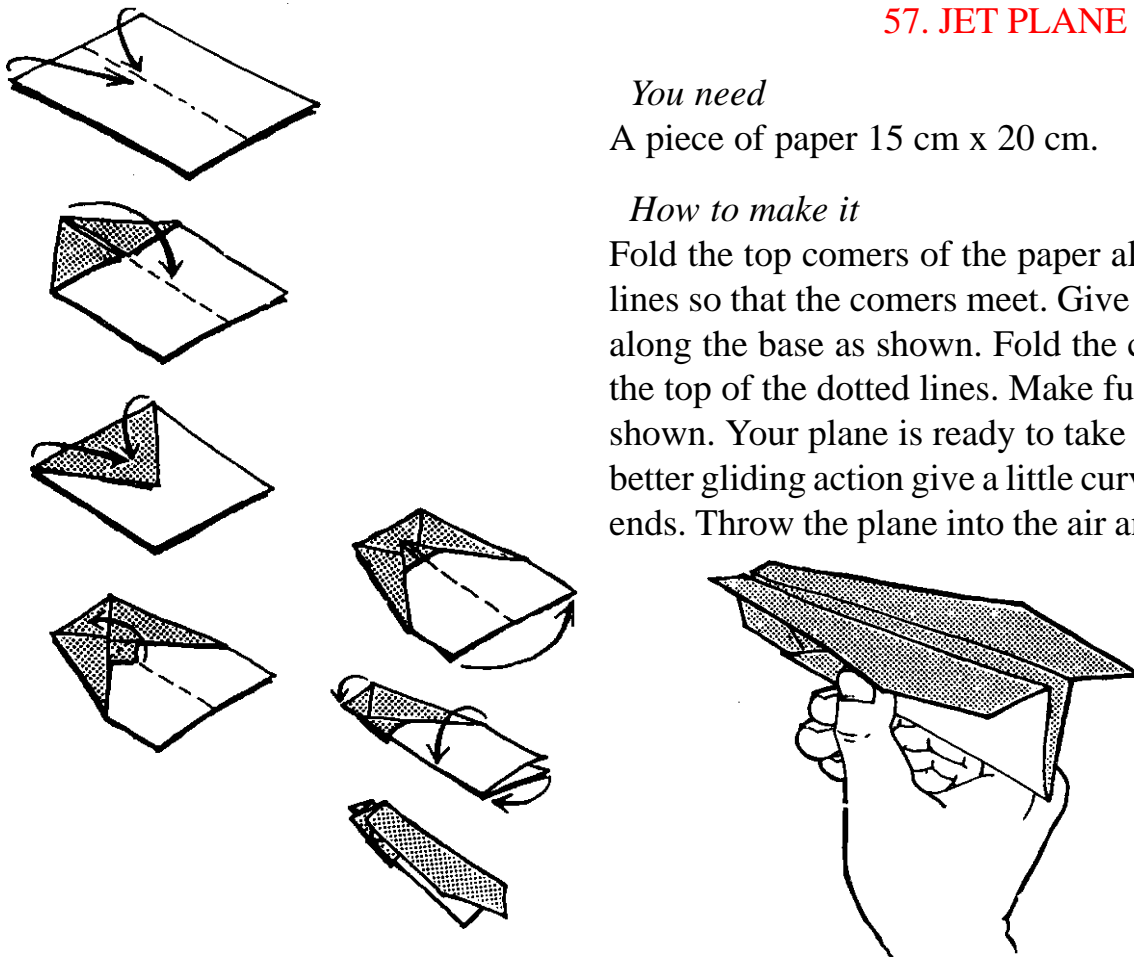

58. AEROPLANE

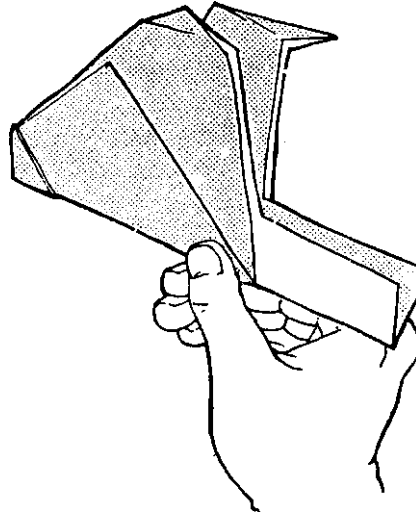
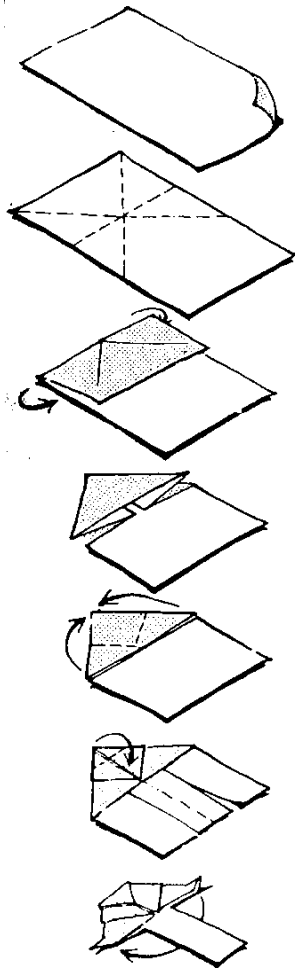

You need
A piece of paper 15 cm x 30 cm.

How to make it
It should be possible for you to construct this toy by following the steps shown in the illustration. Throw the plane up in the air and watch it swing into action.

Find out
Can you figure out why the aeroplane glides?

59. WEIGHING BALANCE

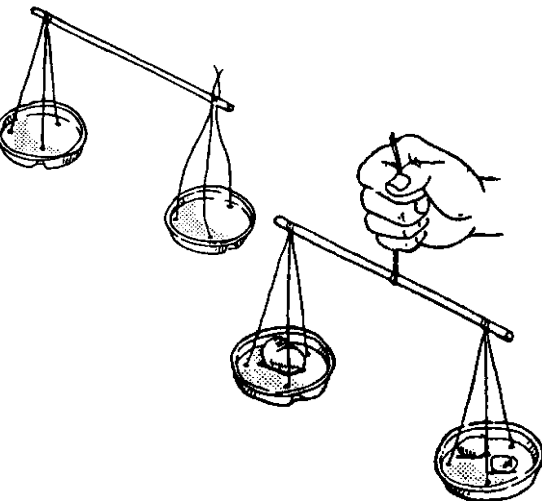
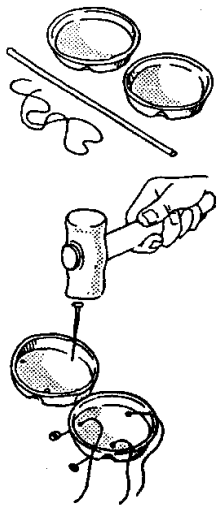

You need
Lids of containers of equal size, a strong string, a bamboo stick, a nail and a hammer.

How to make it
Make three holes in each of the two lids at equal distances. Cut six pieces of the string and pass one through each hole. Tie a knot at the base. Tie the other ends together to make the strings of equal length. Then the both lids to the bamboo stick. Attach a piece of string to the centre of the stick. Your balance is ready.

Try out
You can use other containers provided both are of equal weight; for example, matchboxes, lemon rinds, etc.

Find out
Does this toy work on the same principle as the see-saw in the playground? How do some people cheat while weighing objects even though the pans are of the same weight?

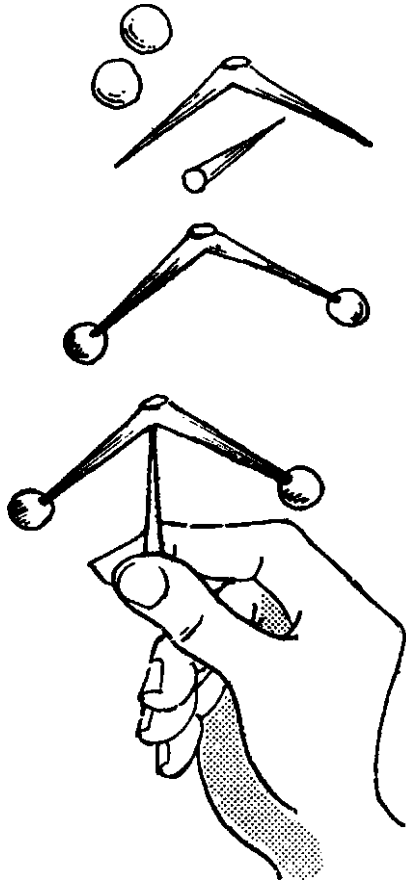

60. GREAT BALANCE

You need

Wet clay balls or goat droppings and a pair of thorns from a *babool* tree.

How to make it

Stick the pointed edges of the them through the goat droppings. Hold this on the tip of another thorn and the toy will balance itself.

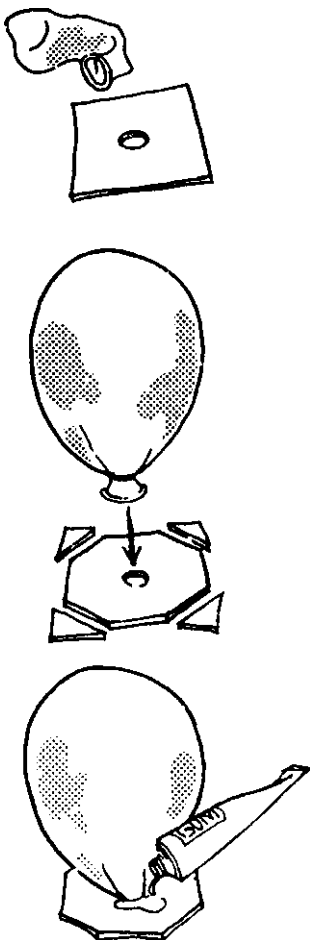

61. BALANCING BALLOON

You need

A piece of cardboard and a balloon filled with air.

How to make it

Inflate a balloon and tie a thread close to its mouth. Make a hole in a cardboard and pass the lower end of the balloon through it. Secure it with glue. Kick the balloon in any way you like; it will invariably return to its original position.

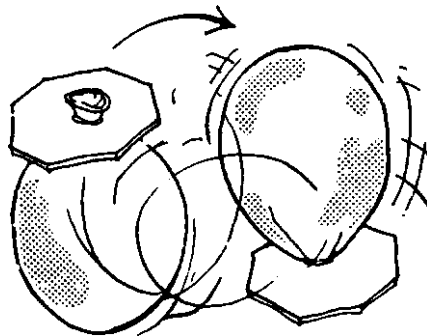

62. ACROBATIC CAPSULE

You need

An empty capsule and a small ball-bearing.

How to make it

Separate the two halves of the capsule, place the ball-bearing into it and replace back the two halves together. The toy is ready. Place it on your palm. Tilt your palm and watch the fun. This toy is based on the principle of the shift in centre of gravity which causes interesting movements.

Try out

Try using a glass marble and a capsule made out of paper three times the size of the marble.

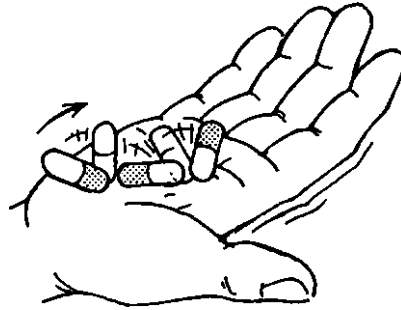
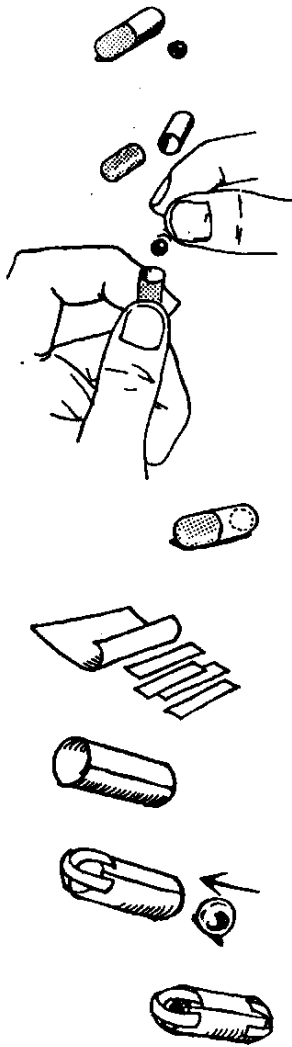

63. GO-NO-GO

You need

An empty spool of thread and a string 80 cm long.

How to make it

Join the two ends of the string by tying them together. Pass the loop of the string through the spool and hold each end on the forefingers of your two hands. Next, hold the string vertically at the two ends. Reverse the position and see the spool move. You can stop the spool midway by stretching the thread in between your fingers.

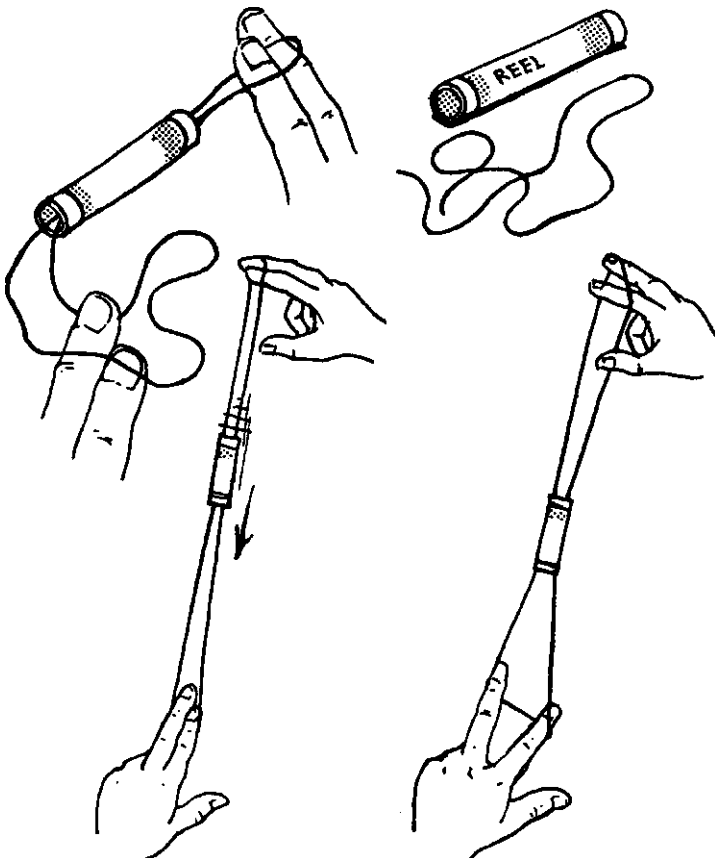

64. PULLEY

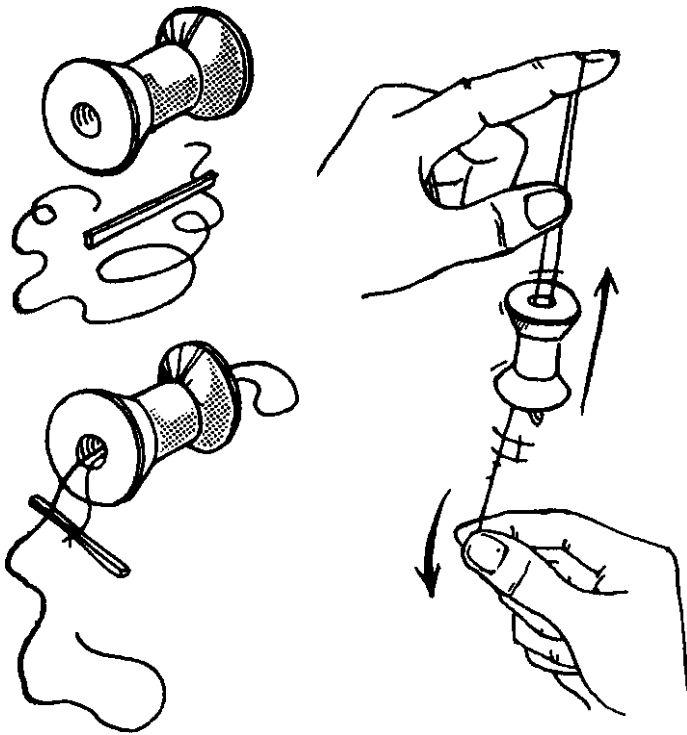

You need

A used reel, a piece of string 80 cm long, two matchsticks.

How to make it

Pass the string through the reel and tie the ends of the string to the matchsticks. When you pull one end of the string, the reel moves upwards.

Find out

Where and for what purpose is this pulley used in our daily life? Why does a cotton thread work better than a nylon one?

65. LID CART

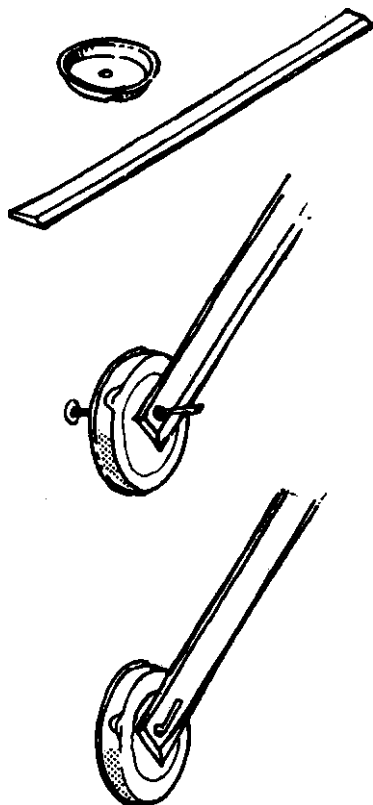

You need

The lid of a shoe-polish tin, wooden or bamboo stick and a nail.

How to make it

Fix the tin to the long wooden stick with the nail. Hold the end of the stick and move the wheel.

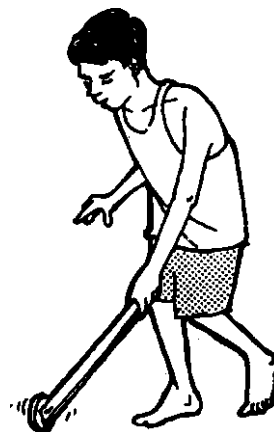

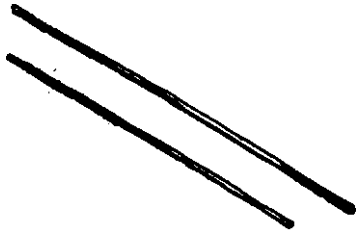

66. WIRE WHEEL

You need

Two pieces of wire 2 mm thick and each 90 cm long, a hammer and a pliers.

How to make it

Bend the two pieces of the wire as shown with the help of a hammer and pliers; and, the wire wheel is ready.

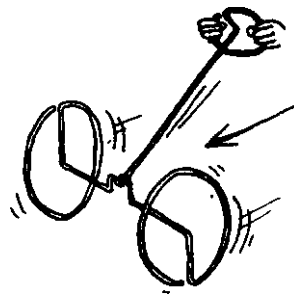
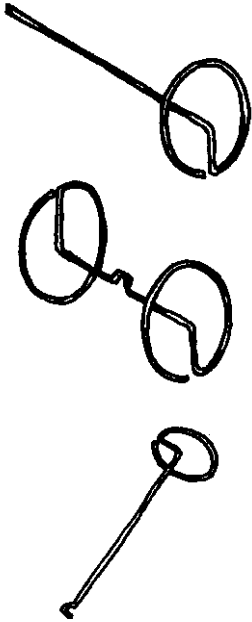

67. CYCLE TYRE WHEEL

You need

An old cycle tyre.

How to make it

Roll the wheel with your hand and balance it when it is in motion. You can also use a stick and balance the wheel with its help. It requires great skill to keep the wheel in motion.

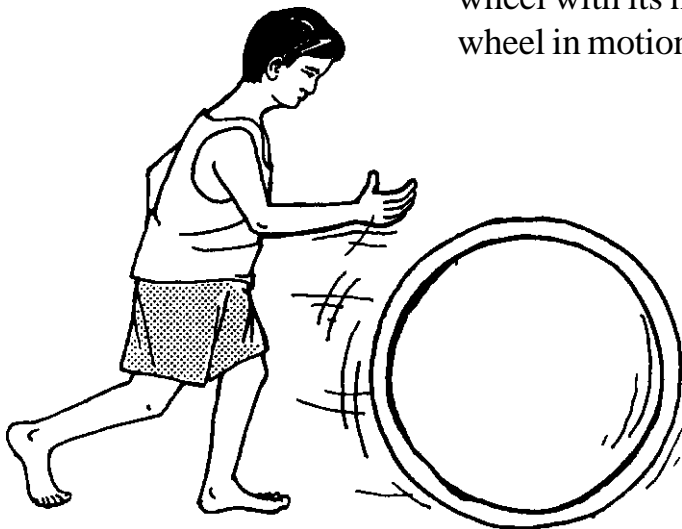

68. REEL CART

You need

A wooden reel and a long thick wire.

How to make it

Bend the wire as shown after passing it through the reel. Your cart is ready to tow along.

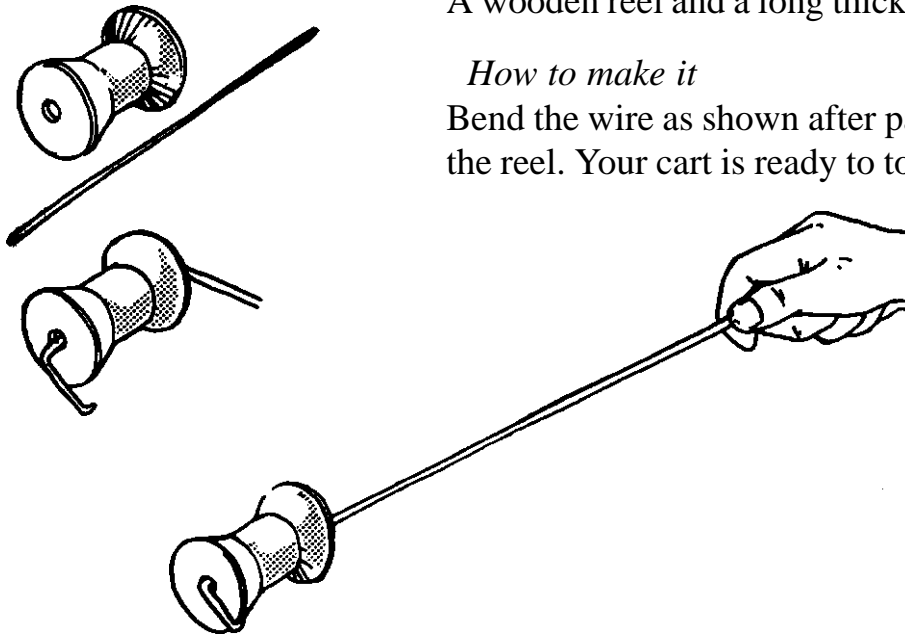

69. CIGARETTE BOX CART

You need

A used cigarette box, four discarded bottle caps, broomsticks, a nail and a hammer.

How to make it

Make holes in the bottle caps with the nail and hammer to make the wheels of the cart. The broomsticks are fixed into the wheels and the cigarette packet as shown. A thread is tied at each end of the caps on the outside to prevent the caps from slipping off. Attach a long thread to the cart and pull it along.

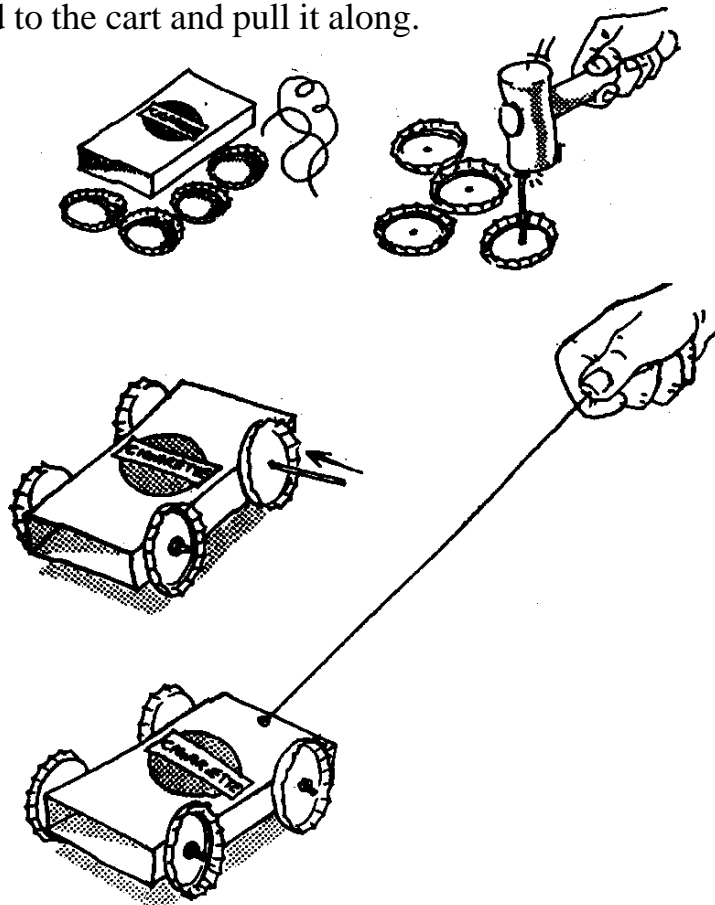

70. SELF-DRIVEN CART OR WAR TANK

You need

A wooden thread reel, a rubber band, two matchsticks and a slice of soap or wax.

How to make it

Cut a groove in the reel for half a matchstick to rest in. Tie one end of the rubber band to the matchstick. Pass the other end of the rubber band through the reel as shown. Make a hole in the wax and pass the rubber band into it as shown. Place a matchstick in the loop of the rubber band.

Now wind it by cranking the matchstick. Place the toy on the floor, and see it move like a tank or a road-roller.

Try out

Instead of a slice of wax try using plastic beads.

Find out

Is the working of this toy similar to that of the spring toys seen in the market?

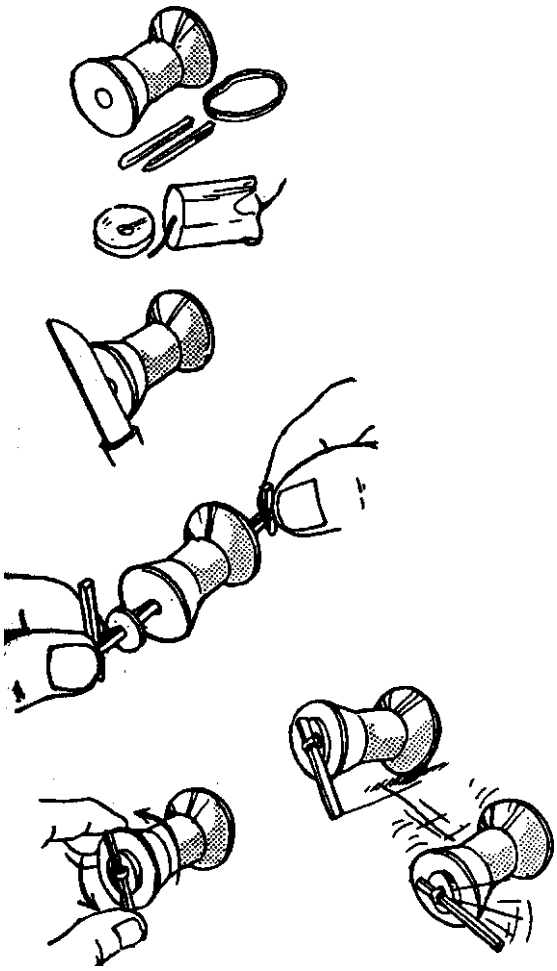

71. HELICOPTER

You need

A wooden ruler, a piece of string and a pair of scissors.

How to make it

Make a hole at one end of the ruler. Pass a string through it and tie a firm knot at the end. Hold the loose end of the string and swing the ruler. A loud, growling sound like that of a helicopter is heard.

Find out

Instead of a ruler, use a bamboo pipe.

Will there be any sound?

If you replace the ruler with an irregular flat piece, will the toy work?

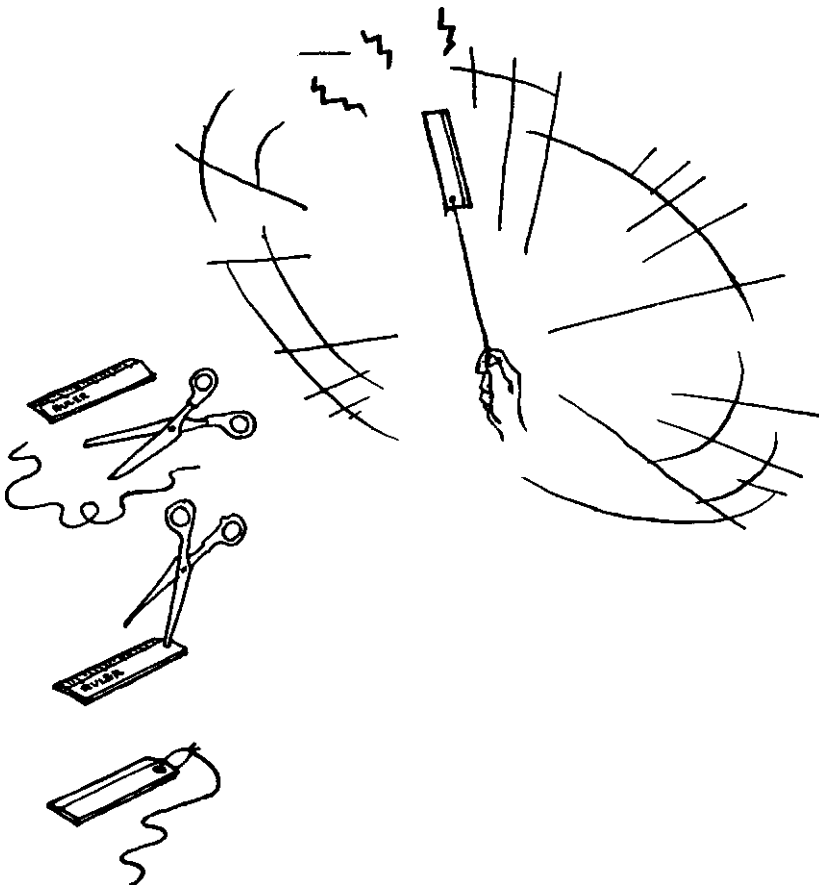

72. SPACE STRIP

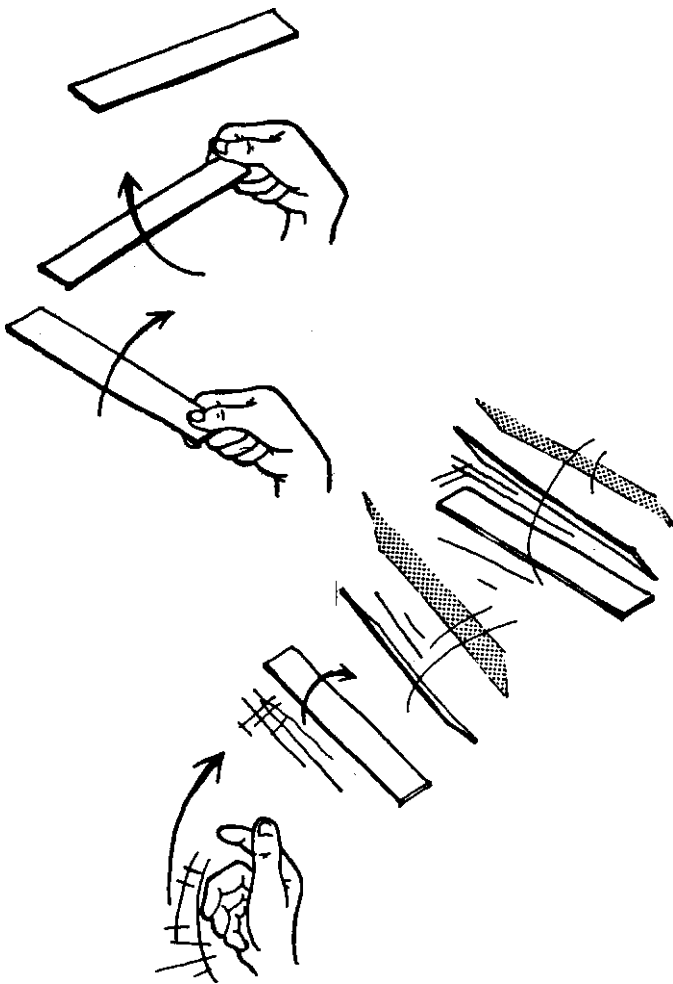

You need

A strip of cardboard 20 cm x 3 cm.

How to make it

Throw the strip up in the air. It will come twirling down, making fascinating movements in the air. This is similar to leaves twirling when they fall in autumn.

Try out

Make strips of various shapes and sizes, using different types of paper.

Find out

Why do strips fall in a rotating motion?

Why do they fall without rotating sometimes?

Why doesn't the toy work if the shape?

73. ROTATING STICK OR MAGIC STICK

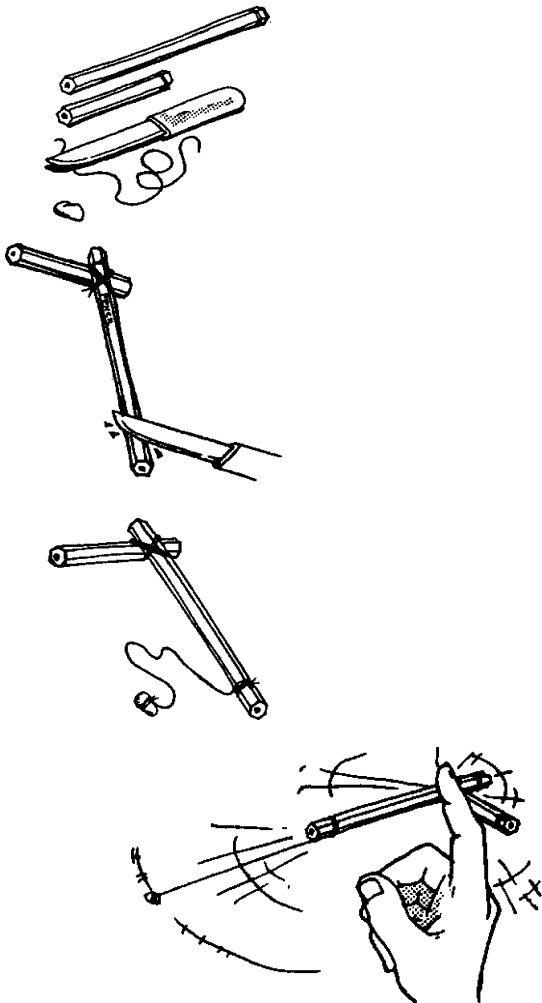

You need

Two used flat-tipped pencils, a stone, a string and a knife.

How to make it

Tie the two pencils together. Make a groove in the bigger pencil with a knife. Tie a small stone to one end of a string. Tie the other end of this string to the groove on the pencil.

Hold your finger on the toy and whirl it around. With practice the toy can be kept in continuous motion.

Try out

Try playing with the toy by removing the weight. Add weight to note the difference. Make this toy with bamboo sticks.

Find out

Can you explain why the pencils rotate without falling down? Why is it easier to play with this toy when it is moving faster?

74. MERRY-GO-ROUND

You need

A lid of a shoe-polish tin, a string and a matchstick.

How to make it

Tie a string through the centre of the tin lid. Fix a matchstick at the other end. Move the lid around as shown. With some practice, you can make the lid move in circles.

Try out

Try using large and small-sized lids.

Find out

Why is it difficult to play with a small-sized wheel?



75. YO-YO

You need

Two circular pieces of thick cardboard 15 cm in diameter, a small pencil stub and a piece of thread 50 cm long.

How to make it

Make a hole in the centre of each disc and fix the pencil as an axle. The distance between the discs should be around 2 cm. Smoothen out the edges of the discs. Tie the thread to the pencil and wind it as shown. Hold the free end of the thread and let the spool go down. Give it a slight jerk when it almost reaches the end of the thread. The spool winds and unwinds itself.

Try out

Make a small and big-sized toy.

Find out

Why is it easier to operate a bigger sized yo-yo? Why is the toy difficult to operate if the discs are far apart? Terms like 'torque' and 'momentum' are used to describe how this toy works. Ask your teacher or your parent to explain the terms.

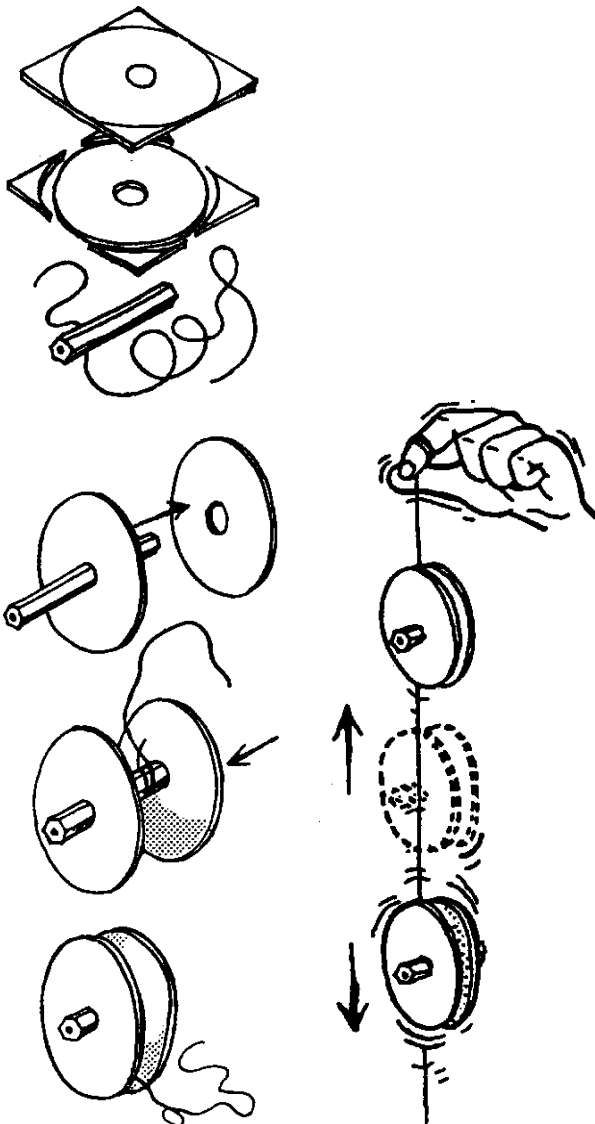

76. BUTTERFLY

You need

A piece of paper 10 cm x 10 cm.

How to make it

Make a diagonal crease on the paper. Place the paper on the floor so that the central portion of it is 1 cm above the ground. Blow air directly under the paper, and watch it flutter like a butterfly.

Try out

Make this toy in different sizes.

Try making a toy using a rectangular piece of paper.

Find out

Why does the fluttering action take place? Is there any similarity between the take off of a modern aeroplane and this toy?

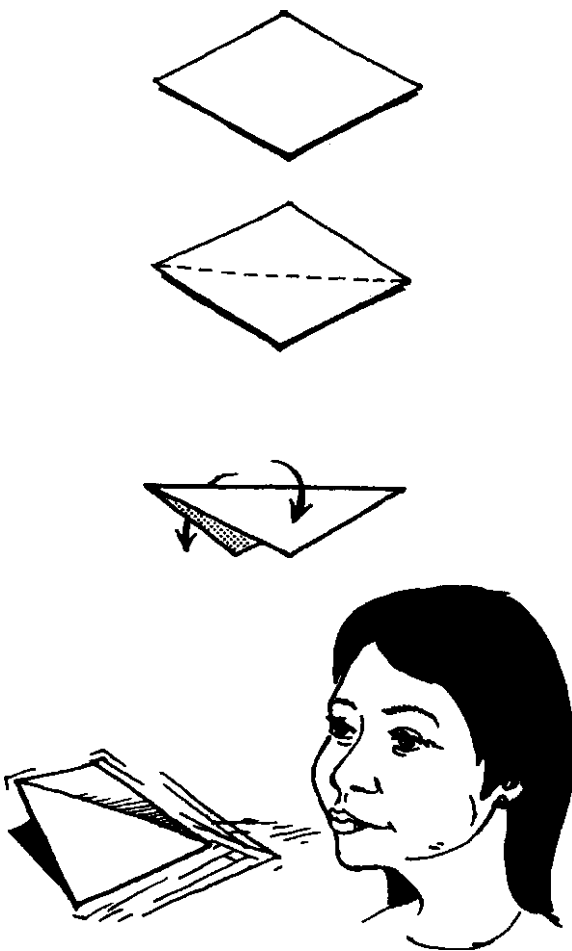

77. PAPER WAVE

You need

A strip of paper 20 cm x 2 cm.

How to make it

Hold the strip of paper as shown and blow. The strip will make an interesting 'wave' motion.

Find out

Why do these papers flutter? Do you know that aeroplanes are based on the same principle? An aeroplane uses a similar principle of physics as this toy! What is this principle called?

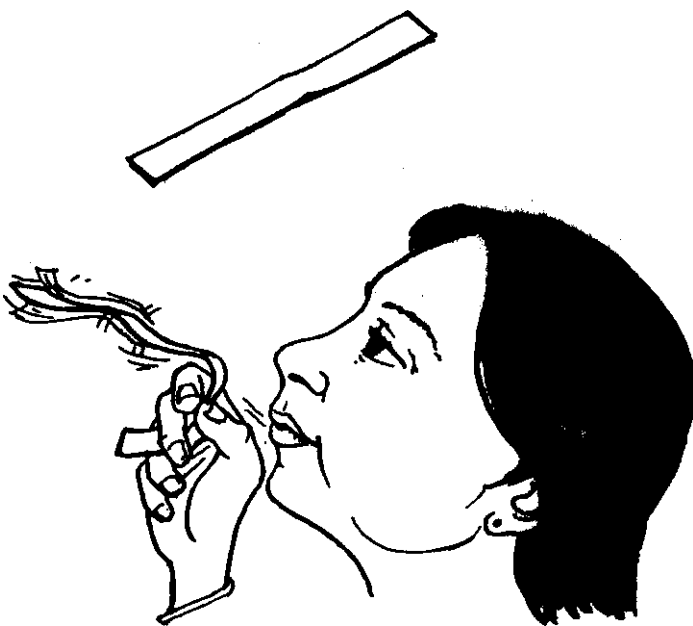

78. PEA IN THE AIR

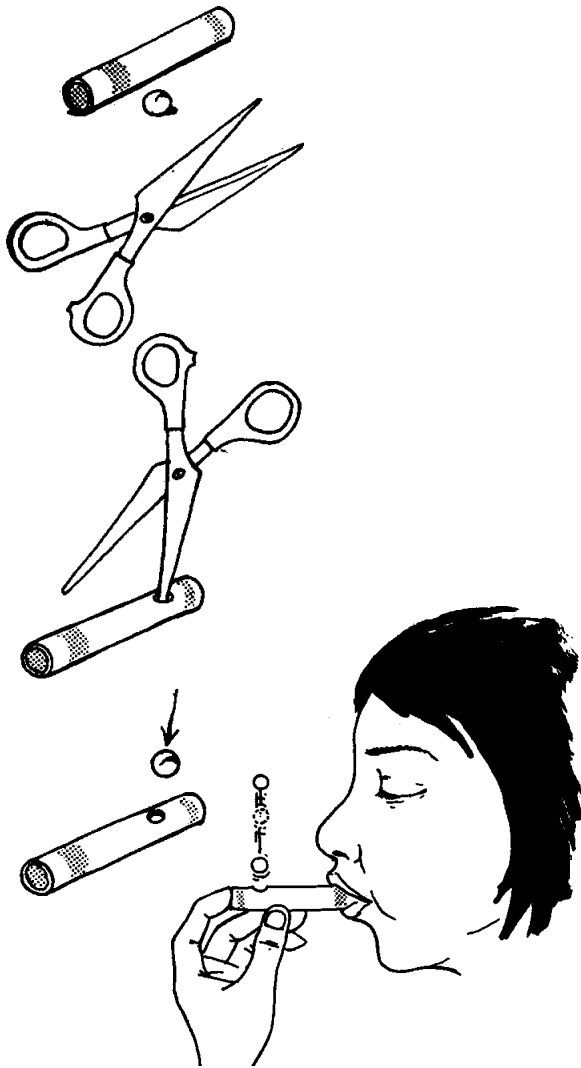

You need

A discarded cardboard spool (used for thread reels) and a pea.

How to make it

Make a hole in the reel as shown. Place a pea or any other similar light-weight spherical seed on the hole. Close one end of the tube with your finger and blow air in from the other end. The seed lifts up in the air-for a moment.

Try out

Instead of the reel you can use any other tube-like form.

You can seal one side of the tube with a piece of paper.

Try using a table-tennis ball instead of a pea.

Play with this toy with your friend and see who can keep the pea in the air for a longer time.

Find out

For how much time can you keep the pea in the air? Why does the pea fall when you close your eyes or when you blow very hard?

79. FLEEING DOLL

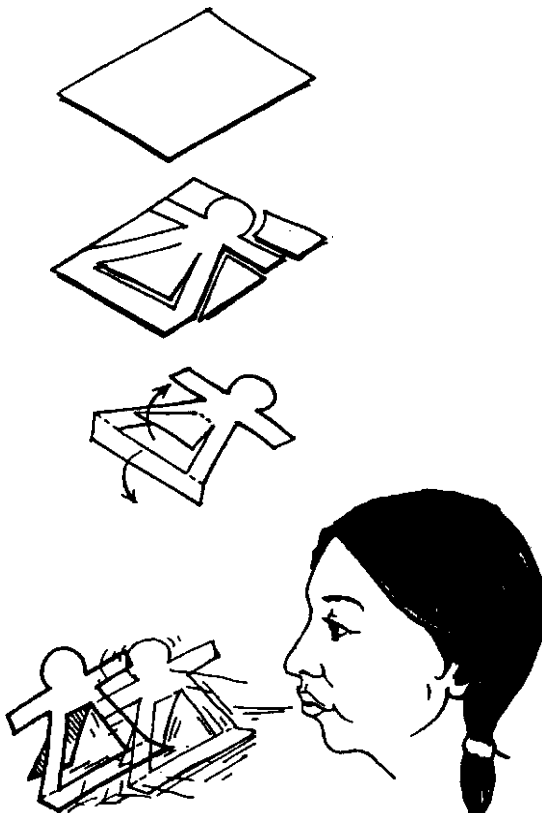

You need

A piece of chart paper 12 cm x 12 cm and a paper cutter.

How to make it

Draw the figure of a doll on the piece of paper. Cut the figure as shown. Cut along the dotted line to make a stand for the doll. Now blow air at the base of the doll. It will slide without falling down.

Try out

Use different types of paper. Make dolls of various sizes. Instead of a doll, make animals and birds of different shapes.

Find out

Why does it topple down when you blow too hard? Do you see similarities between this toy and a sail-boat?

80. RUNAWAY WHEEL

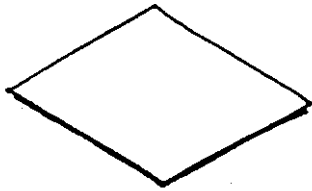

You need

A paper circle of 12 cm radius and a pair of scissors.

How to make it

Make slits around the circle at equal distances as shown.

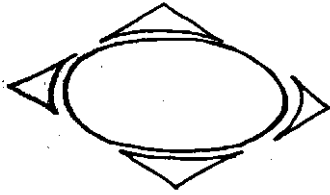

Bend the slits forward and backward alternately. Now blow air on to the toy. It slides instead of toppling down.

Find out

Will the wheel rotate if it is not exactly circular?

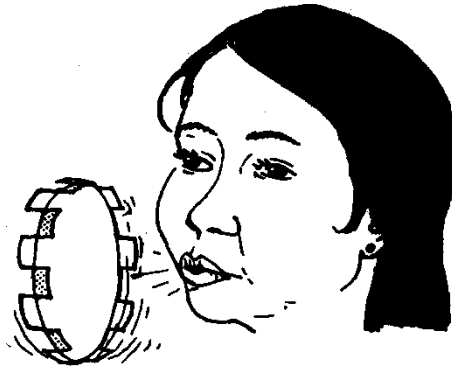
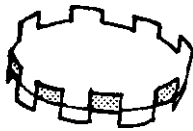
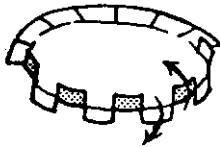
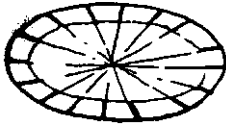

81. CIGARETTE-LEAF FROG

You need

The foil from an empty cigarette packet

How to make it

Fold the foils indicated. Turn it upside down and press it at the other end with your finger. The foil jumps like a frog.

Try out

Paint the paper to resemble a frog.

Try having a frog race with your friends.

Make frogs of different sizes and with various types of paper.

Find out

Suppose the frog was made of wood or clay, would it jump?

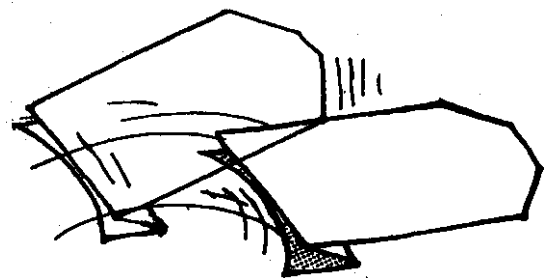
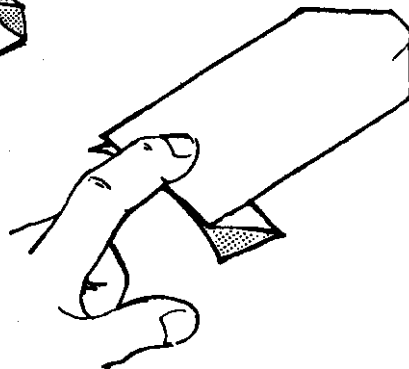
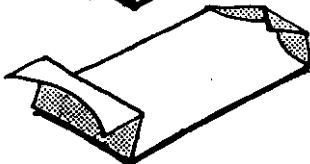
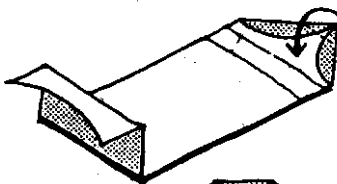
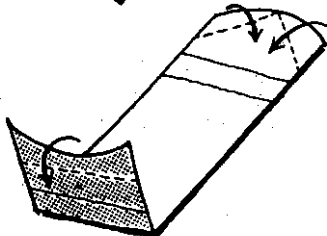
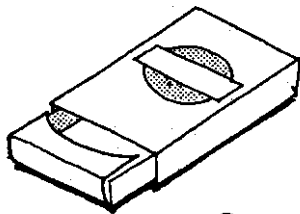

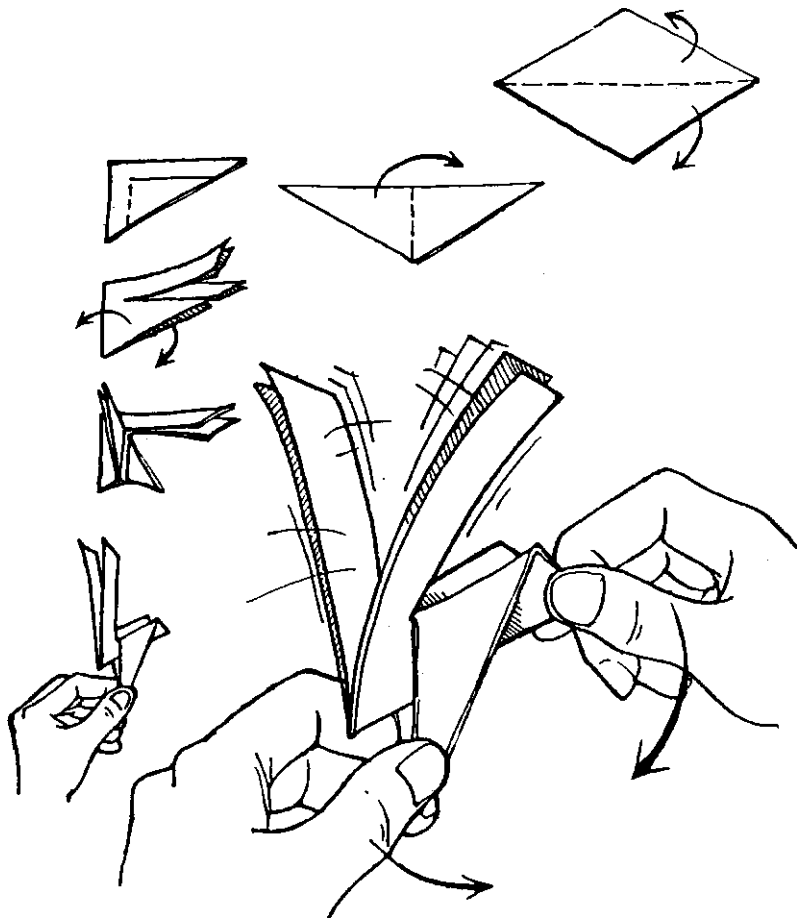

82. RABBIT

You need

A piece of paper 15 cm x 15 cm.

How to make it

Fold the paper diagonally into a triangle. Give another fold as shown. Make a cut through the two layers. Fold both sides to make the feet. Hold the feet in your hand and make the tail-end move to and fro. The ears will make interesting movements.

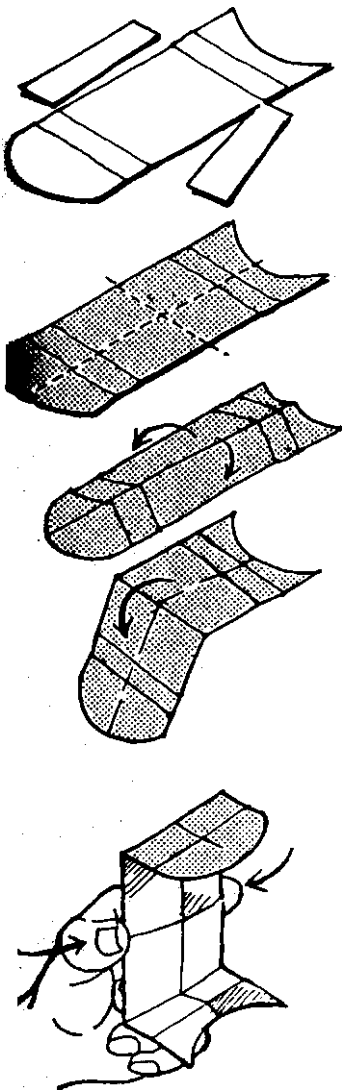

83. CAMERA

You need

A cigarette foil.

How to make it

Crease the cigarette foil as shown. Then hold it and press it in the middle. The top and the bottom flaps will swiftly come together, giving the feel of a camera 'click'.

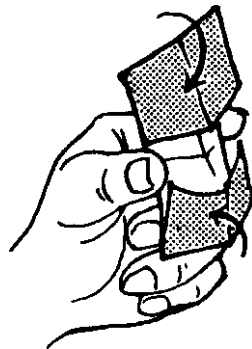

SECTION 4

MINI MYSTERIES

In life children find endless fascination in things happening around them. An unexpected motion, an unusual sound, the unravelling of a simple mystery-all provide fun and joy to children, And this constitutes a part of growing up. Over the years small tricks, strange puzzles, and 'magical' experiences have inspired many to create simple ingenious playthings. The following pages illustrate how 'ordinary' playthings become something 'extraordinary' when made with one's own hands.

84. FLICK KNIFE

You need

Three discarded ice-cream sticks, a matchstick and two rubber bands.

How to make it

Make semi-circular grooves on both ends of one stick. On the second stick, make grooves on one end as shown. On the third stick make grooves on one end and sharpen the other end. Place a piece of matchstick and secure the two sticks firmly with a rubber band. Attach the third stick too, with another rubber band. For locking the toy, place it as shown. On pressing the rear catch, the knife flicks open.

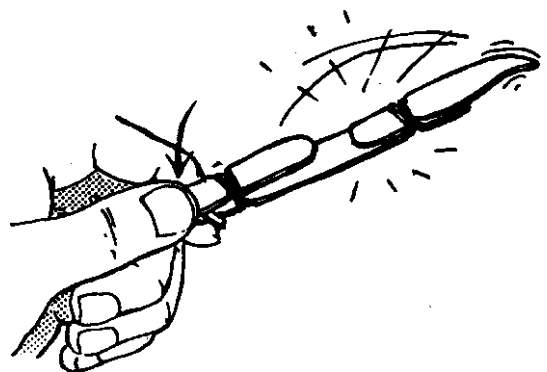
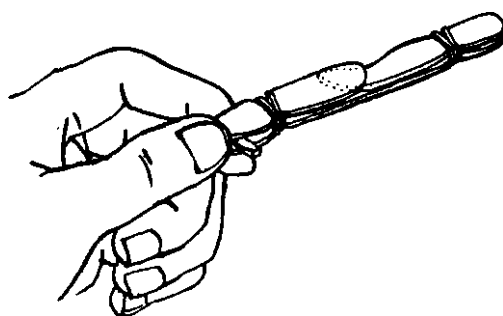
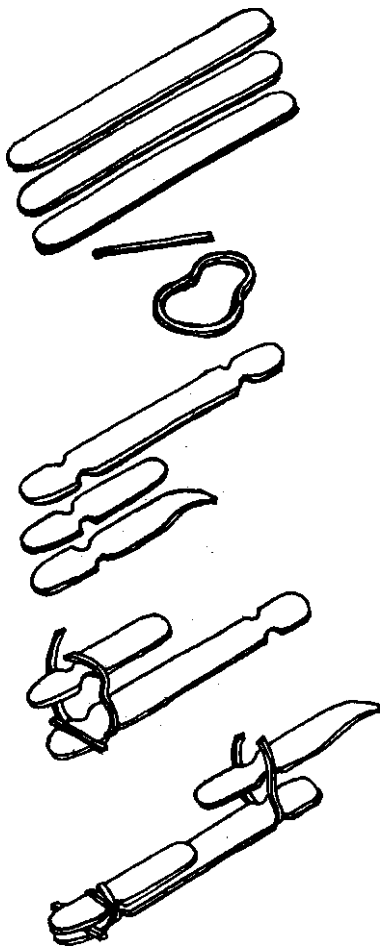

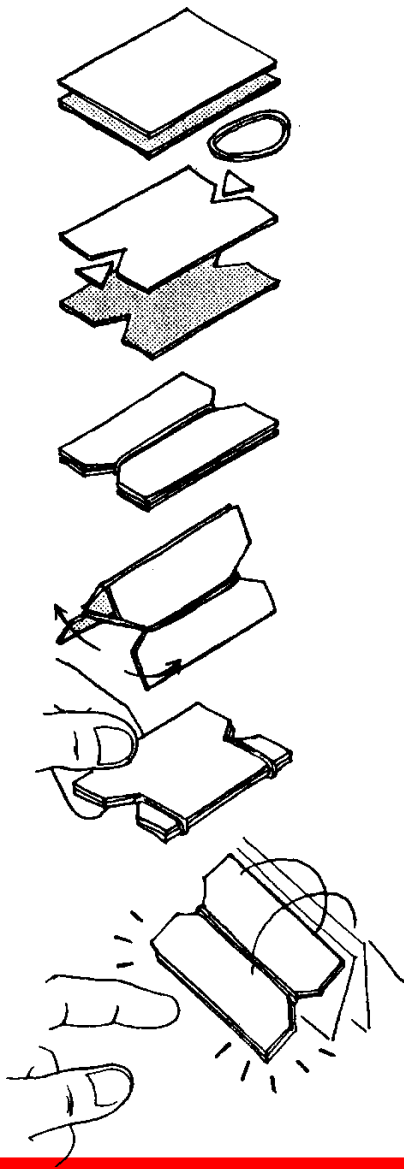

85. CLAP IN THE AIR

You need

Two pieces of cardboard 6 cm x 5 cm,
a pen-knife and a rubber band.

How to make it

Make 'V' cuts on the two pieces as shown.
Pass the rubber bands through the grooves to
join the cardboards. Fold these pieces in the
opposite direction in the form of a book and
throw the toy in the air.

You will hear a loud bang.

When placed on a table the toy jumps on its own.

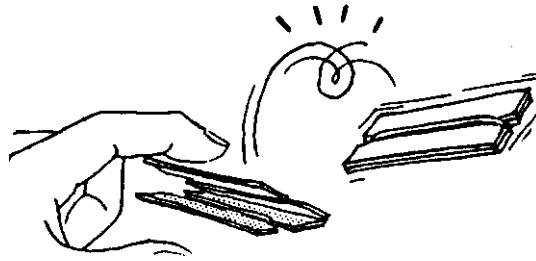

86. MISCHIEVOUS BALL

You need

An old, used tennis or rubber ball and a
marble.

How to make it

Cut the ball into two halves. Press the top to
make a dent. Place the marble in the dent and
wait. After some time the marble shoots up
into the air and the dent disappears.

There is another way to play with this toy.
Place the old ball with the dented side touching
the floor. Wait. The ball will jump up on its
own.

Find out

Why does the ball jump up?

Will a similar toy made out of a new ball work?

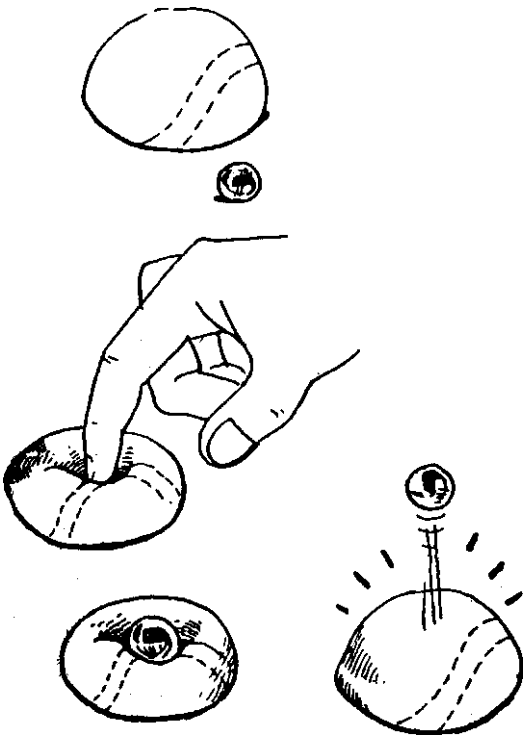

87. FIGHTING PENCILS

You need

Two pencil stubs and a small rubber band.

How to make it

Pass the pencils through the rubber band. The rubber band should hold the pencils tightly as shown. Turn the pencils to give twists to the rubber band. Place the two pencils on the floor and swiftly remove your hold. The pencils will jump about as though they are engaged in a battle with each other.

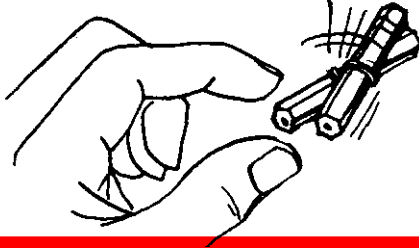
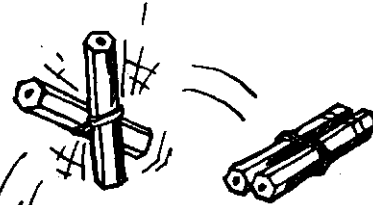
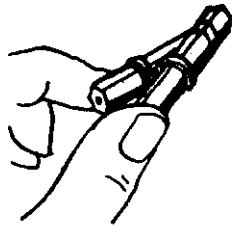
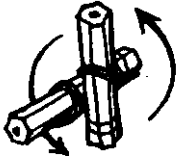
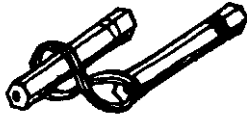
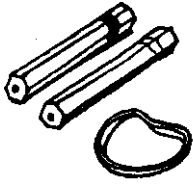

88. GIFT PACKET

You need

A button, a rubber band, a broken piece of bangle and a piece of paper.

How to make it

Pass the cut rubber band through the two holes of the button. Tie the two ends of the rubber band to the piece of bangle. Give a few twists to the rubber band by turning the button. Wrap this twisted rubber band in a paper. It looks like a gift-pack.

Present this gift to your friend, and watch the anticipatory look on his or her face. On opening the packet see your friend jump at the rumbling sound. Your friend might even throw away the packet thinking that a live insect is placed inside.

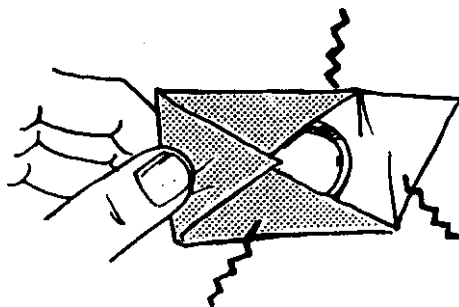
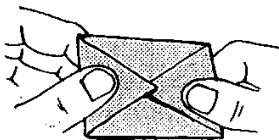
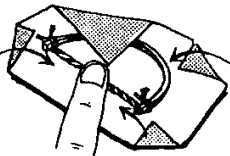
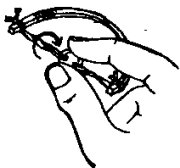
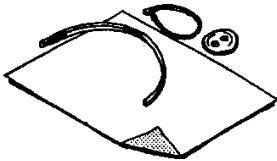

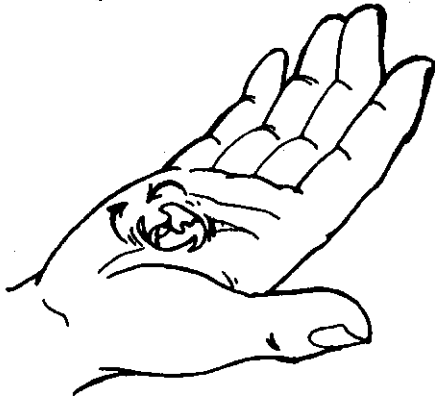
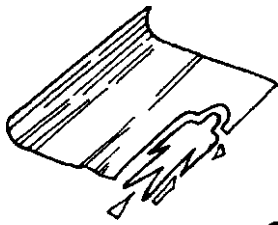

89. LIVELY PAPER

You need

A piece of cellophane paper and a pair of scissors.

How to make it

Cut a small piece of cellophane paper and place it on your palm. The paper rises and makes movements on its own.

Try out

Try making various forms with the paper, say, a human figure or a flower.

Find out

Why does the cellophane paper behave this way?

90. HOT AND COLD

You need

A soap-nut seed (*aritha*).

How to make it

Place the seed in your friend's hand and ask if it is hot or cold. "Its cold", will be the reply. Now rub the seed on the polished door and make your friend touch it. She will retract her hand as the seed feels hot to touch.

Find out

Why does the seed become hot when rubbed?

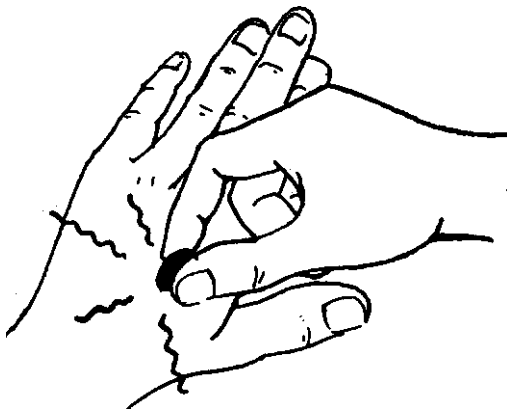
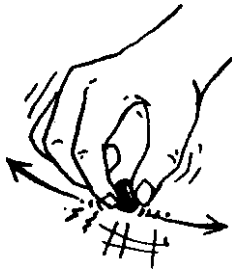

91. MAGNETIC COMB

You need

A comb, a tiny piece of paper and a string.

How to make it

Attach the paper to the string. Run the comb through your dry hair. Bring the comb near the tiny piece of paper and see it drawn towards the comb.

Find out

Why does this happen?



92. CLOCK

You need

A matchbox, a pin, a piece of thread, a small stone and a safety pin.

How to make it

Tie one end of the thread to the stone. Tie the other end to the safety pin as shown. Make a hole right through the two broad sides of the matchbox. Insert the pin through one hole, then through the rear end of the safety pin placed inside and finally through the second hole. Bend the point of the pin to fix it firmly. Hold the matchbox vertically and give it a jerk. The stone tied to the thread moves like a pendulum. This action also produces a 'tik-tik' sound like that made by an old wall-clock.

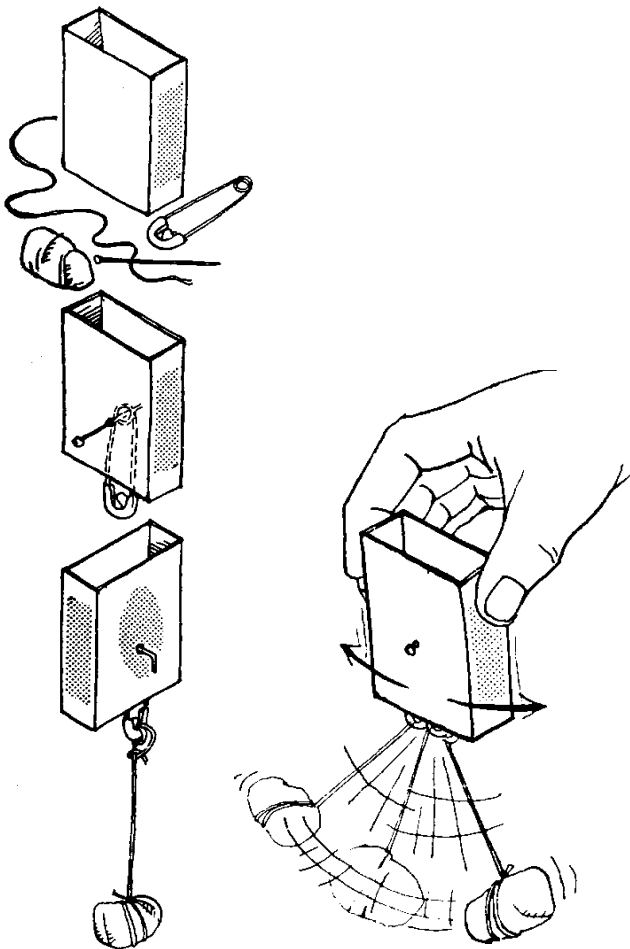

93. BOUNCY BALL

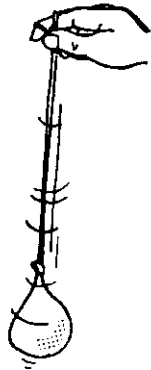
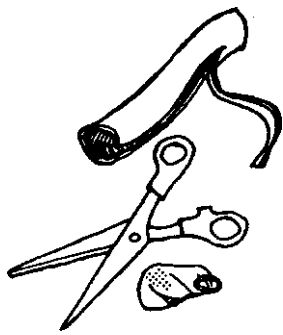

You need

A rubber elastic string about 50 cm long. It can be like the one used in making belts for undergarments or else use a thin rubber strip cut out of a discarded cycle tube. Take also a water-filled balloon.

How to make it

Attach the water-filled balloon to the rubber string. Hold the free end of the rubber string tightly and move your hand by giving it a little jerk. The balloon moves up and down like a yo-yo.

Try out

Use different weights instead of the balloon. Try playing the game of catch-catch with this toy.

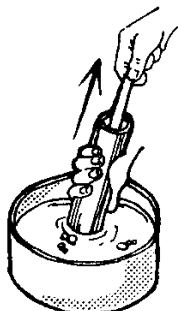
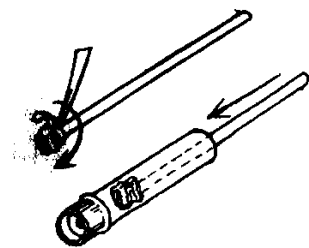
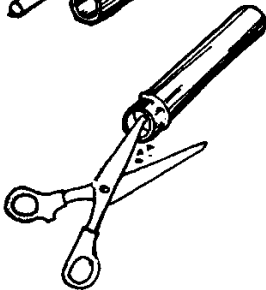
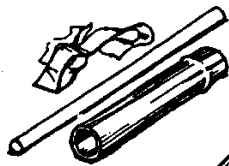

94. WATER SYRINGE

You need

A bamboo pipe 20 to 30 cm long, a bamboo stick and a strip of cloth.

How to make it

Cut the bamboo piece so that one end is closed. Make a small hole in this end of the pipe. Take a bamboo stick and wrap a strip of cloth firmly around one end. The diameter of the cloth bundle should be equal to the inner side of the bamboo pipe. Dip the water syringe (*pitchkari*) in water and pull the stick up till the end. Water will get drawn into the pipe. Now push in the stick. A jet of water spurts out.

Try out

Make two or three holes in the bamboo pipe to make a sprinkler.

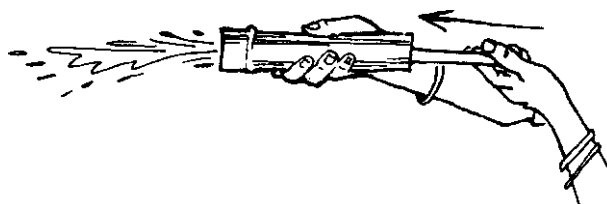

95. SOAP BUBBLES

You need

Soap solution (add a quarter measure of glycerine to one measure of liquid detergent, diluted with five measures of water) and a straw.

How to make it

Take the straw and dip it in the soap solution. Take it out and gently blow through the other end. You will see soap bubbles of various sizes flying around you.

Find out

Why do you see colours in the soap bubbles?

Note

Do you know that these soap bubbles have the thinnest walls seen in any man made object?



96. MAGIC WATER POT

You need

A container with a tight lid, a hammer and a nail.

How to make it

Pierce several tiny holes at the bottom of the container and a hole in the lid. Fill the container with water. On placing your finger on the hole of the lid, the water does not now out. But when you lift your finger, water starts flowing. You can show this to your friends as a magic trick.

Find out

Do you know why this happens?

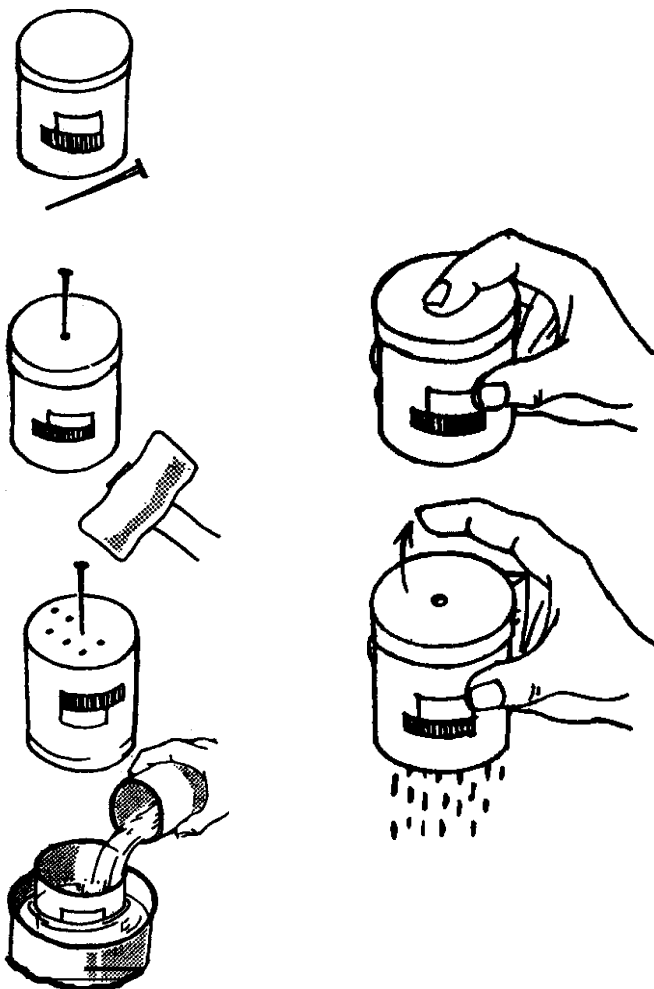

97. JACOB'S LADDER

You need

Two empty cigarette packets, a pair of scissors, glue and a piece of paper with one side plain and the other side coloured.

How to make it

Remove the draw trays from inside the packets. Take the paper and cut six pieces of equal length, each 3 cm more than the cigarette packets. Fix the three strips of paper to the packets as shown.

When you hold the toy at the centre of the packet and hip it downwards, the other packet comes down. As a result, you now see the strips change their colour. With every flip the paper hinges turn over.

Note

Have you seen this toy with a colourful flower enclosed between the packets during a fair or a *mela*?

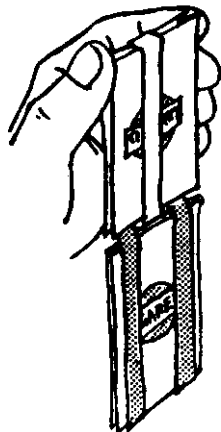
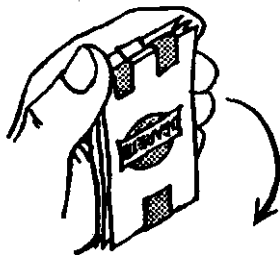
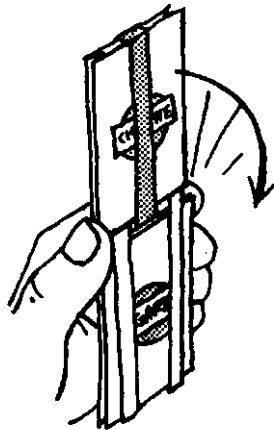
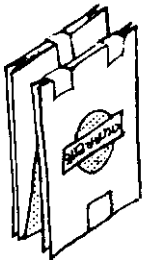
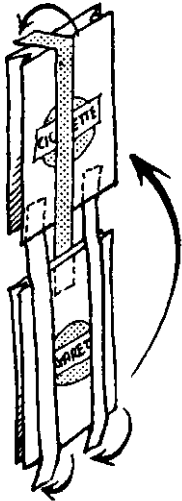
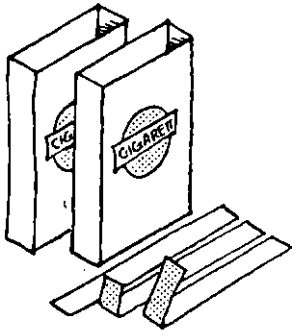

98. PARROT IN A CAGE

You need

A circular piece of cardboard, a string and colour pens.

How to make it

On one side of the disc paint the picture of a parrot and on the other side, a cage. Tie a string at the top. On rotating this disc by rolling the string in your hand, you will notice that the parrot seems to be inside the cage.

Try out

Make other combinations, like a man in a house.

Note

This toy is based on the persistence of vision. Do you know that the cartoon films you see on the TV screen or in the cinema are based on the same principle?

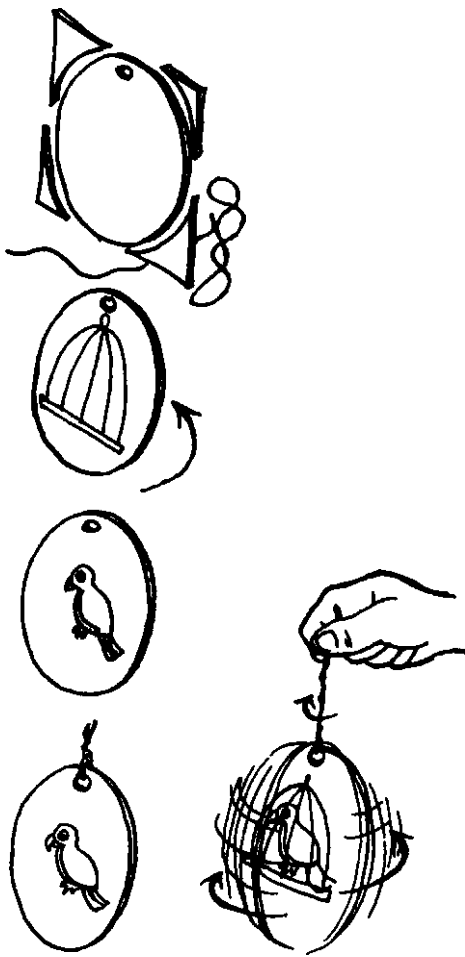

99. DANCING EYES

You need

A sheet of paper, a carbon paper and a pencil.

How to make it

Fold the sheet of paper and place the carbon paper in between. Draw the head of a boy. Remove the carbon paper to get two identical images. Now add the eyes. In one picture the eyes should look to the left, and in the other, to the right. Now flip the top paper back and forth. You will see the eyes moving from side to side.

Note

This principle is used in making animation films.

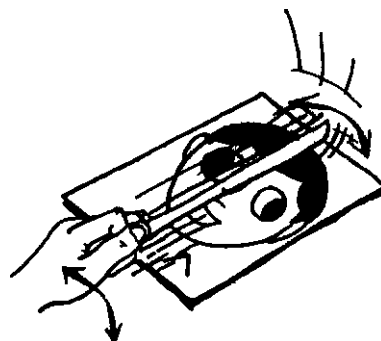
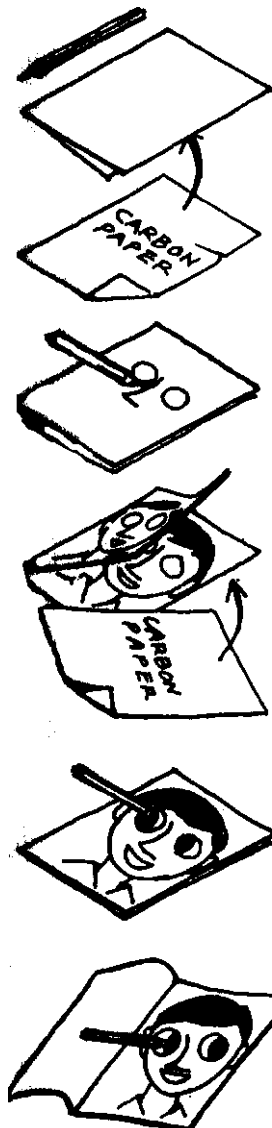

100. SEWING MACHINE (SOUND)

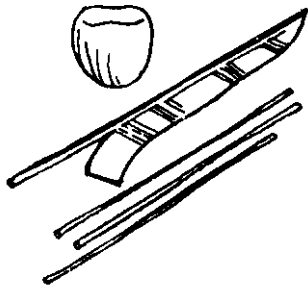

You need

A baby coconut and three coconut leaf-veins, each 25 cm long (or a small potato and strong broomsticks).

How to make it

Take a coconut leaf-vein and insert both ends into the tiny soft coconut to make a loop as shown. Now, insert a stick about 15 cm long into the coconut. Take two coconut veins, each about 20 cm long and place them as indicated. Now rotate the toy. This action produces a sound similar to that of a sewing machine.

Try out Make this toy by using a potato and broomsticks. (If the potato is not fixed properly it might fly off along with the sharp-edged sticks.)

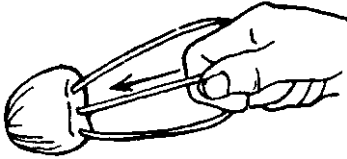
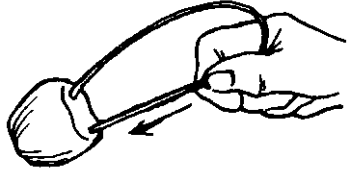

Find out

Can you tell us how sound is produced?

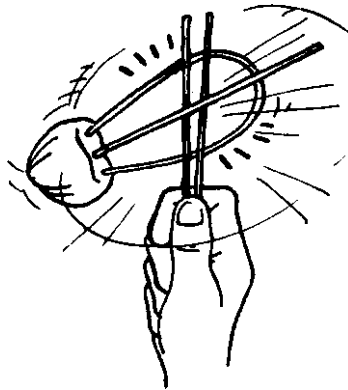
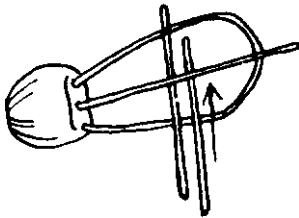

101. SEWING MACHINE (STITCHES)

You need

The same materials as used in the previous toy, and a leaf.

How to make it

You can adapt the sewing machine to produce stitches. Pluck a small leaf and insert it in the toy as shown. Now rotate this toy. You will hear the ticking sound. Notice the line of dots on the leaf. It would seem as if the leaf has been put under an actual sewing machine.

Find out

Can you figure out why stitch-like holes are made?

Ask your friends from Kerala to make this toy for you and tell you of any other adaptation they may have tried.

